



---

*QUALITY TRUCK PARTS*

*SINCE 1961*

**BUMPERS & ACCESSORIES  
CATALOG**

*version 25.1*



ISO 9001  
ISO 14001

1961-2021  
**60**  
YEARS

**VP** Valley  
Chrome  
Plating  
QUALITY TRUCK PARTS



For **OVER 60 YEARS**, the trucking industry has put its trust in Valley Chrome Plating, Inc./Wingmaster. We are a hard working, family-owned American business. A huge THANK YOU to those who have helped us build our reputation for stellar aftermarket bumpers, visors, light panels, LED accessory lighting and more!

Please visit us on our website and join the excitement on our social media pages by posting pictures of our products on your trucks.

Our knowledgeable staff is ready to serve you by phone as well, by calling 1.800.354.0976.

---

# TOM LUCAS

IN MEMORIAM

October 13, 1953 – December 17, 2020



We are a family at Valley Chrome. 2020 marked a difficult year in our company's history. We lost our brother, friend, Vice President and General Manager, Tom Lucas.

In addition to his passion for our company, Tom loved his wife, his daughters, his son and his four grandchildren. He also enjoyed scuba diving and accomplished over 750 dives all over the world.

Tom led us well and will be sorely missed by all who knew him.

---

# TABLE OF CONTENTS

## BUMPERS

Part Numbering Guide.....	7
Autocar.....	8
Ford.....	9-10
Freightliner.....	11-26
GMC.....	27-29
Hino.....	30
International.....	31-38
Kenworth.....	39-47
Mack.....	48-58
Peterbilt.....	59-72
Sterling.....	73-74
Volvo.....	75-80
Western Star.....	81-85
White.....	86
Universal Mount Blank Bumpers.....	87
Blind Mount Bumpers.....	88
Bumper Customization Options.....	89-91
Bumper Mounting Bolt Kits.....	92

## UNIVERSAL ACCESSORIES..... 94

Flap Weights.....	95
Tank Straps.....	95
Tag Hangers.....	95
Permit Panels.....	96
Ridged Permit Panels.....	97
Beacon Light Brackets.....	97
Airline Boxes.....	98
Deck Plates.....	99
Front Deck Plate Tool Box.....	99
Rear Frame Tool Box.....	100
Head Light Visors.....	101
Frame Steps.....	101
Rear Window Visors.....	102
Rear Frame Fillers.....	102-103
Lower Rear Frame Fillers.....	104
Retail Display - LEDs.....	105
LED Light Option Chart.....	106
Blank Light Cutout Options.....	107
LED Lights.....	108-114
Wire Harnesses.....	115

## PETERBILT MODEL 359 ACCESSORIES..... 116

Cab Panel 3.5".....	117
Hood Extensions.....	117
Misc. Trim Pieces.....	118
Standard Mount Stainless Visors.....	119
Gangster Stainless Visors.....	119
Wicked Visors.....	119
Air Deflectors.....	120
Fuel Tank Strap Covers.....	120
Misc. Trim Pieces.....	121

## PETERBILT MODELS 365 & 367

### ACCESSORIES..... 122

Cab Panel 4".....	123
Sleeper Panels 4".....	124
Sleeper Extension Panels 4".....	125
Air Cleaner Light Boxes.....	126
Bug Shields.....	126

## PETERBILT MODEL 379

### ACCESSORIES..... 127-128

One-Piece Cab/Hood Extension Panels.....	129
Cab Panels 4".....	130
Cab Panels 6".....	130
Hood Extension Panels 4".....	131
Hood Extension Panels 6".....	131
Sleeper Panels 4".....	132
Sleeper Panels 6".....	132
Sleeper Extension Panels 4".....	133
Sleeper Extension Panels 6".....	133
Air Cleaner Light Boxes Vortex.....	134
Mirror Light Boxes.....	135
Bumper & Grille Trim.....	136
Fender Guards.....	136
Bug Shields.....	137
Blinker Bars.....	138
Fender Support Covers.....	138
Sleeper Filler Panels.....	139
Sleeper Shock Covers.....	139
Air Deflectors.....	140
Fuel Tank Strap Covers.....	140
Fuel Tank Fairings.....	141
Emblems.....	142
Misc. Trim Pieces.....	142-143
Battery Boxes & Tool Boxes.....	144
Tool & Battery Box Covers.....	145

## PETERBILT MODEL 384..... 146

Cab Panels 4".....	147
Cab Panels 6".....	147
Sleeper Panels 4".....	148
Sleeper Panels 6".....	148
Sleeper Extension Panels 4".....	149
Sleeper Extension Panels 6".....	149

## PETERBILT MODEL 386..... 150

Cab Panels 2.5".....	151
Exhaust Filler Panel 2.5".....	151
Sleeper Panels 2.5".....	152
Sleeper Extension Panels 2.5".....	153
Bug Shields.....	153

## PETERBILT MODELS 388 & 389..... 154

Formed Cab Panels 4".....	155
Formed Cab Panels 6".....	155
One-Piece Cab/Hood Extension Panels.....	156-158
Cab Panels 4".....	159
Cab Panels 6".....	159
Cab Panels No DEF System.....	160
Cab Panels DEF System.....	160

Table of Contents continued on next page

# TABLE OF CONTENTS

Table of Contents continued from previous page

## **PETERBILT MODELS 388 & 389 (cnt'd)**

Sleeper Panels 4" .....	161
Sleeper Panels 6" .....	161
Hood Extension Panels 4" .....	162
Hood Extension Panels 6" .....	162
Hood Extension Panels 4" .....	163
Hood Extension Panels 6" .....	163
388 Cab Panel DEF System.....	164
Sleeper Extension Panels 4" .....	165
Sleeper Extension Panels 6" .....	165
Air Cleaner Light Boxes Donaldson .....	166
Mirror Light Boxes.....	167
Bumper & Grille Trim .....	168
Fender Guards .....	168
Bug Shields.....	168
Emblems.....	169
Fender Trim .....	169
Hood Trim .....	169
Blinker Bars.....	170
Fender Support Cover.....	170
Stainless Visors .....	171
Sleeper Filler Panels .....	171
Misc. Trim Pieces .....	172-173
Sleeper Shock Covers .....	174
Air Deflectors.....	174
Fuel Tank Strap Covers.....	175
Exhaust Covers.....	175
Tool & Battery Box Covers .....	176
Battery Boxes & Tool Boxes .....	177
Box Step Highlights/Protectors .....	177

<b>PETERBILT MODEL 567</b> .....	178
Cab Panel .....	179
Sleeper Panels.....	179
Hood Extension Panels.....	179
Fender Guards .....	179
Bug Shields.....	180
Fuel Tank Strap Covers.....	180
Stainless Visors.....	181

<b>PETERBILT MODEL 579</b> .....	182-183
Cab Panel .....	184
Sleeper Panels.....	184
DEF System Panels.....	185
Misc. Trim Pieces .....	186-187
Stainless Visors.....	188
Sleeper Shock Covers .....	189
Tank Fairing Highlight.....	189
Kick Panel Trim .....	189

<b>PETERBILT MODEL 587</b> .....	190
Fender Trim .....	191
Stainless Visors .....	191
Misc. Trim Pieces .....	192

<b>PETERBILT MODEL 589</b> .....	193
Fender Trim .....	194

<b>ACCESSORIES FOR ALL PETERBILT MODELS</b> .....	195
Hood Emblems.....	196-197
Hood Latch Guards .....	197
Key Guards .....	198
Misc. Trim Pieces.....	198
Bug Shield for model 387.....	199
Window Trim.....	199
Sleep Window Lower Looks .....	199
Stainless Visors.....	200-203
Sleeper Wraps .....	204
Rear Frame Covers .....	204
DEF Tank Covers.....	205
Fuel Tank Wraps.....	205

<b>KENWORTH MODEL W900</b> .....	206
Cab Panels .....	207
Sleeper Panels.....	208
Hood Extension Panels.....	209
Sleeper Extension Panels.....	209
Air Cleaner Light Boxes .....	210
Air Cleaner Fairings.....	211
Exterior Window Trim .....	212
Exhaust Shields .....	212
Bug Shields.....	212
Blinker Bars.....	213
Flap Weights .....	213
Fender Guards .....	214
Battery & Tool Box Covers.....	214
Hood & Grille Trim.....	215
Stainless Sun Visors.....	216-218
Catalytic System Box Highlights .....	219
DEF Tank Cover.....	219
Stainless Deck Plates .....	219
Fuel Tank Fairings.....	220
Lower Hood Panels.....	221
Center Hood Trim.....	221

<b>KENWORTH MODEL T600</b> .....	222
Sleeper Panels.....	223
Sleeper Extension Panels.....	223
Stainless Grilles.....	224
Bug Shields.....	224
Battery & Tool Box Covers.....	225
Side Marker Trim.....	225

<b>KENWORTH MODEL T660</b> .....	226
Cab Panels .....	227
Bug Shields.....	227
Stainless Sun Visors.....	227
Gangster Visors.....	228
Boltless Wicked Visors.....	228
Battery & Tool Box Covers.....	229

Table of Contents continued on next page

# TABLE OF CONTENTS

Table of Contents continued from previous page

<b>KENWORTH T680</b> .....	230
Cab Panels.....	231
Sleeper Extension Panels.....	231
Door and Window Trim.....	231
Bug Shields.....	232
Fender Guards.....	232
Stainless Sun Visors.....	232
DEF Tank Cover.....	233

<b>KENWORTH T800 &amp; T880</b> .....	234
Sleeper Panels.....	235
Sleeper Extension Panels.....	235
Bug Shields.....	236
Fender Guards.....	236
Stainless Sun Visors.....	236
Gangster Visors.....	237
Boltless Wicked Visors.....	237
Battery & Tool Box Covers.....	238
Exterior Window Trim.....	239
Door Handle Trim.....	239
Lower Look.....	239
Air Deflectors.....	239
Emblem Accents.....	240
Hood Latch Guards.....	240
Sleeper Window Trim.....	241
Rear Frame Covers.....	241
Stainless Fuel Tank Wraps.....	241

<b>FREIGHTLINER FLD/CLASSIC</b> .....	242
Cab Panels 4".....	243
Sleeper Panels.....	243
Hood Latch Guards.....	244
Hood Trim.....	244
Lowered Look Window Panels.....	244
Misc. Trim Pieces.....	245
Air Cleaner Light Boxes.....	245
Fender Guards.....	246
Headlight Visors.....	246
Stainless Trim For Plastic Bumpers.....	246
Bug Shields.....	247
Drop Visors.....	248
Wicked Boltless Visors.....	249

<b>FREIGHTLINER CENTURY &amp; COLUMBIA</b> .....	250
Cab Panels 4".....	251
Sleeper Panels.....	251
Misc. Trim Pieces.....	251
Stainless Trim for Plastic Bumpers.....	252
Bug Shields.....	252
Sun Visors.....	253

<b>FREIGHTLINER CORONADO 2002-2009 &amp; GLIDER KITS</b> .....	254
Bug Shields.....	255
Sun Visors.....	255

<b>FREIGHTLINER CASCADIA 2017 &amp; OLDER "P3"</b> .....	256
Cab Panels 4".....	257
Sleeper Panels.....	257
Fairing Panels.....	258
Fender Trim.....	259
Hood & Door Trim.....	259
Lowered Look Window Panels.....	259
Stainless Trim For Plastic Bumpers.....	260
Bug Shields.....	260
Sun Visors.....	261
Fuel Tank Covers.....	262
Battery Box Covers & Steps.....	262
Catalytic Covers.....	262
Emblem Accents.....	263
Permit Panels.....	263
Fuel Tank Fairing.....	263

<b>INTERNATIONAL</b> .....	264
Sun Visors.....	265

<b>VOLVO VNL</b> .....	266
Hood & Fender Trim.....	267
Bug Shield.....	267
Stainless Trim For Factory Visors.....	267
Fairing Highlights.....	268

<b>VOLVO VT SERIES</b> .....	269
Cab Panels.....	270
Sleeper Panels.....	270
Hood Extension Panels.....	271
Hood & Fender Trim.....	271-272
Bug Shield.....	272
Sun Visors.....	272
Battery Box Cover.....	273
Fuel Tank Fairings.....	273

<b>WESTERN STAR 4700SF</b> .....	274
Cab Panels.....	274
Fender Guards.....	274
Bug Shields.....	275
Radiator Rock Guard.....	275
Sun Visors.....	276

<b>WESTERN STAR 5700XE</b> .....	277
Sun Visors.....	277
Bug Shields.....	277

<b>TURBOWING BY WINGMASTER</b> .....	278
The Turbowing Advantage.....	279
Pickup Truck Wings.....	280
Aerolight 700 Series Intro.....	281
900 Series Intro.....	281
Peterbilt Wings/Mounting Kits.....	282
Kenworth Wings/Mounting Kits.....	283
Freightliner Wings/Mounting Kits.....	284
International Wings/Mounting Kits.....	285
Western Star Wings/Mounting Kits.....	286
Pro Tail Wings.....	287

<b>NOTES</b> .....	288
--------------------	-----

<b>WARRANTY AND RETURN POLICIES</b> .....	289
---	-----

# BUMPER PART NUMBERING & OPTIONS GUIDE

## How our BUMPER part numbering system works:

We use a "smart" part number. Every digit has a meaning, which indicates how we build your bumper. Make sure all digits are correct to have your bumper built correctly!

Example Part Number:

HC – 0010 – 06 – 21BY

### TRUCK MAKE

H = Peterbilt

### TRUCK MODEL

C = Model 379

Search the following bumper pages to find this two digit code.

### CUTOUPS













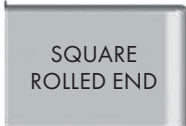

0010 = mounting holes and tow hole. Visit the bumper pages in this catalog for available cutout options.

### END STYLE

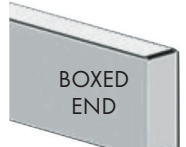
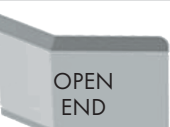
06 = 18 inch Rolled End Square. See this chart for end style choices. Varies by make/model. See bumper pages.

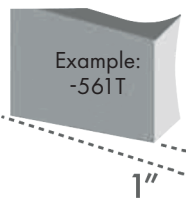
### OPTIONS

21BY = 21 open Bullseye 3/4 light holes. No code needed here if the rest of the part number completes your bumper. See p. 88-91 for some options.

 <p>TAPER ROLLED END</p> <p>"STANDARD TAPER"</p> <table border="1"> <tr><td>12"</td><td>01</td></tr> <tr><td>16"</td><td>02</td></tr> </table>	12"	01	16"	02	 <p>TAPER HAND FORM</p> <table border="1"> <tr><td>12"</td><td>91</td></tr> <tr><td>14"</td><td>30</td></tr> <tr><td>16"</td><td>92</td></tr> <tr><td>18"</td><td>03</td></tr> <tr><td>20"</td><td>31</td></tr> <tr><td>22"</td><td>32</td></tr> </table>	12"	91	14"	30	16"	92	18"	03	20"	31	22"	32	 <p>SETBACK AXLE</p> <table border="1"> <tr><td>9"</td><td>29</td></tr> <tr><td><b>12 to 14"</b></td><td><b>15</b></td></tr> <tr><td>16"</td><td>16</td></tr> <tr><td>18"*</td><td>17</td></tr> <tr><td>20"*</td><td>34</td></tr> </table>	9"	29	<b>12 to 14"</b>	<b>15</b>	16"	16	18"*	17	20"*	34	 <p>AMERICAN EAGLE BOXED END WITH 8" EARS</p> <table border="1"> <tr><td>12"</td><td>54</td></tr> <tr><td>16"</td><td>55</td></tr> <tr><td>18"</td><td>56</td></tr> <tr><td>20"</td><td>57</td></tr> <tr><td>22"</td><td>58</td></tr> </table>	12"	54	16"	55	18"	56	20"	57	22"	58	 <p>AMERICAN EAGLE BOXED END WITH 6" EARS</p> <table border="1"> <tr><td>12"</td><td>54A</td></tr> <tr><td>16"</td><td>55A</td></tr> <tr><td>18"</td><td>56A</td></tr> <tr><td>20"</td><td>57A</td></tr> <tr><td>22"</td><td>58A</td></tr> </table>	12"	54A	16"	55A	18"	56A	20"	57A	22"	58A		
12"	01																																																			
16"	02																																																			
12"	91																																																			
14"	30																																																			
16"	92																																																			
18"	03																																																			
20"	31																																																			
22"	32																																																			
9"	29																																																			
<b>12 to 14"</b>	<b>15</b>																																																			
16"	16																																																			
18"*	17																																																			
20"*	34																																																			
12"	54																																																			
16"	55																																																			
18"	56																																																			
20"	57																																																			
22"	58																																																			
12"	54A																																																			
16"	55A																																																			
18"	56A																																																			
20"	57A																																																			
22"	58A																																																			
 <p>SQUARE ROLLED END</p> <p>"TEXAS SQUARE"</p> <table border="1"> <tr><td><b>18"</b></td><td><b>06</b></td></tr> <tr><td>20"</td><td>41</td></tr> <tr><td>22"</td><td>42</td></tr> </table>	<b>18"</b>	<b>06</b>	20"	41	22"	42	 <p>SQUARE ROLLED HAND FORM</p> <table border="1"> <tr><td>10"</td><td>00</td></tr> <tr><td>12"</td><td>04</td></tr> <tr><td>14"</td><td>21</td></tr> <tr><td>16"</td><td>05</td></tr> <tr><td>18"</td><td>96</td></tr> <tr><td>20"</td><td>97</td></tr> <tr><td>22"</td><td>98</td></tr> </table>	10"	00	12"	04	14"	21	16"	05	18"	96	20"	97	22"	98	 <p>SET FORWARD AXLE</p> <table border="1"> <tr><td><b>12"-13"</b></td><td><b>18</b></td></tr> <tr><td>16"</td><td>19</td></tr> <tr><td>18"</td><td>20</td></tr> <tr><td>20"</td><td>35</td></tr> </table>	<b>12"-13"</b>	<b>18</b>	16"	19	18"	20	20"	35	 <p>AMERICAN EAGLE ROLLED END WITH 8" EARS</p> <table border="1"> <tr><td>12"</td><td>64</td></tr> <tr><td>16"</td><td>65</td></tr> <tr><td>18"</td><td>66</td></tr> <tr><td>20"</td><td>67</td></tr> <tr><td>22"</td><td>68</td></tr> </table>	12"	64	16"	65	18"	66	20"	67	22"	68	 <p>AMERICAN EAGLE ROLLED END WITH 6" EARS</p> <table border="1"> <tr><td>12"</td><td>64A</td></tr> <tr><td>16"</td><td>65A</td></tr> <tr><td>18"</td><td>66A</td></tr> <tr><td>20"</td><td>67A</td></tr> <tr><td>22"</td><td>68A</td></tr> </table>	12"	64A	16"	65A	18"	66A	20"	67A	22"	68A
<b>18"</b>	<b>06</b>																																																			
20"	41																																																			
22"	42																																																			
10"	00																																																			
12"	04																																																			
14"	21																																																			
16"	05																																																			
18"	96																																																			
20"	97																																																			
22"	98																																																			
<b>12"-13"</b>	<b>18</b>																																																			
16"	19																																																			
18"	20																																																			
20"	35																																																			
12"	64																																																			
16"	65																																																			
18"	66																																																			
20"	67																																																			
22"	68																																																			
12"	64A																																																			
16"	65A																																																			
18"	66A																																																			
20"	67A																																																			
22"	68A																																																			
 <p>BOXED END</p> <p>"SQUARE BOXED"</p> <table border="1"> <tr><td>12"</td><td>09</td></tr> <tr><td>16"</td><td>10</td></tr> <tr><td><b>18"</b></td><td><b>11</b></td></tr> <tr><td>20"</td><td>51</td></tr> <tr><td>22"</td><td>52</td></tr> </table>	12"	09	16"	10	<b>18"</b>	<b>11</b>	20"	51	22"	52	 <p>OPEN END</p> <table border="1"> <tr><td>10"</td><td>27</td></tr> <tr><td><b>12"</b></td><td><b>12</b></td></tr> <tr><td><b>14"</b></td><td><b>25</b></td></tr> <tr><td><b>14" (w/Taper)</b></td><td><b>26</b></td></tr> <tr><td>16"</td><td>13</td></tr> <tr><td>18"</td><td>14</td></tr> <tr><td>20"</td><td>61</td></tr> <tr><td>22"</td><td>62</td></tr> </table>	10"	27	<b>12"</b>	<b>12</b>	<b>14"</b>	<b>25</b>	<b>14" (w/Taper)</b>	<b>26</b>	16"	13	18"	14	20"	61	22"	62	 <p>WRAP AROUND "FACTORY STYLE"</p> <table border="1"> <tr><td>10"</td><td>24</td></tr> <tr><td>12"</td><td>22</td></tr> <tr><td>14"</td><td>38</td></tr> <tr><td>16"</td><td>23</td></tr> </table>	10"	24	12"	22	14"	38	16"	23	 <p>Example: -561T</p> <p><b>CUSTOM TAPERS:</b></p> <p>Add "1T" for 1" TAPER Example: -561T = AMER. EAGLE BOX, 18" to 17" TAPER</p> <p>Add "2T" for 2" TAPER Example: -742T = BOXED END, 20" to 18" TAPER</p>															
12"	09																																																			
16"	10																																																			
<b>18"</b>	<b>11</b>																																																			
20"	51																																																			
22"	52																																																			
10"	27																																																			
<b>12"</b>	<b>12</b>																																																			
<b>14"</b>	<b>25</b>																																																			
<b>14" (w/Taper)</b>	<b>26</b>																																																			
16"	13																																																			
18"	14																																																			
20"	61																																																			
22"	62																																																			
10"	24																																																			
12"	22																																																			
14"	38																																																			
16"	23																																																			
 <p>GULLWING</p> <table border="1"> <tr><td>16"</td><td>07</td></tr> </table>	16"	07		 <p>BOXED END TAPER</p> <table border="1"> <tr><td>12"</td><td>70</td></tr> <tr><td>14"</td><td>71</td></tr> <tr><td>16"</td><td>72</td></tr> <tr><td>18"</td><td>73</td></tr> <tr><td>20"</td><td>74</td></tr> <tr><td>22"</td><td>75</td></tr> </table>	12"	70	14"	71	16"	72	18"	73	20"	74	22"	75	 <p>ROADRUNNER 45° MITRE END</p> <table border="1"> <tr><td>12"</td><td>111</td></tr> <tr><td>16"</td><td>112</td></tr> <tr><td>18"</td><td>113</td></tr> <tr><td>20"</td><td>114</td></tr> <tr><td>22"</td><td>115</td></tr> </table>	12"	111	16"	112	18"	113	20"	114	22"	115																									
16"	07																																																			
12"	70																																																			
14"	71																																																			
16"	72																																																			
18"	73																																																			
20"	74																																																			
22"	75																																																			
12"	111																																																			
16"	112																																																			
18"	113																																																			
20"	114																																																			
22"	115																																																			

\* NOTE: No Warranty on setback bumpers 20" and wider, except COA, COB and LI series.

Standard sizes are in bold.

**ALSO SEE OUR "BUILD A BUMPER" CONFIGURATION TOOL ON OUR WEBSITE**

# AUTOCAR BUMPERS

AVAILABLE STYLES FOR PRODUCTS ON THIS PAGE:

AA, AB	Width	End Style Code	AA, AB	Width	End Style Code	KB	Width	Bumper Length	End Style Code
TAPER ROLLED END	16"	02	SQUARE ROLLED END	16"	05	WRAP AROUND	12"	94"	22
	18"	03		18"	06		12"	88"	22-88"
	20"	31		20"	41				
	22"	32		22"	42				

## AA

**AUTOCAR**  
WITH 2" BREAKBACK  
NOT AVAILABLE IN 12" WIDTH

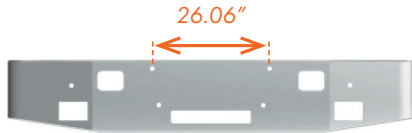

AA-2011-02



AA-2010-02



AA-2001-02



AA-0011-02



AA-2000-02



AA-0010-02



AA-0001-02



AA-0000-02

## AB

**AUTOCAR**  
WITH 2" BREAKBACK



AB-2010-02



AB-2000-02



AB-0010-02



AB-0000-02



**QUALITY TRUCK PARTS**



# FORD BUMPERS

AVAILABLE STYLES FOR PRODUCTS ON THIS PAGE:

BA	Width	End Style Code
<p>TAPER ROLLED END</p>	12"	01
	16"	02
	18"	03
	20"	31
	20"	32
	22"	32

BA	Width	End Style Code
<p>SQUARE ROLLED END</p>	10"	00
	12"	04
	16"	05
	18"	06
	20"	41
	20"	42
	22"	42
	22"	42

BF, BG	Width	End Style Code
<p>SETBACK AXLE</p>	9"	29
	12"	15
	16"	16
	16"	17
	*18"	17

\* No warranty for 18" width on models BF & BG

**L, LN, LT, LTN, LTL -800-900-8000-9000 YEARS 1970-1998**

ALSO MODELS LN7000 & STERLING LT9511

MUST BE 16" WIDE OR LARGER FOR 4 FOG LIGHT OPTION

**BA**



BA-4010-02

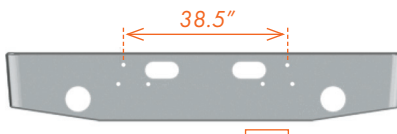

BA-1010-02



BA-4000-02

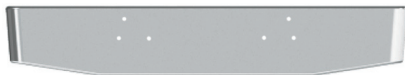

BA-0000-02

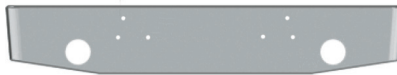

BA-1000-02



BA-0010-02

**AEROMAX SETBACK AXLE - L, LS, LA, LTS, LTA YEARS 1988-1995**

CHECK 'BG' SERIES PRIOR TO ORDERING

**BF**



BF-0000-29



BF-0010-29

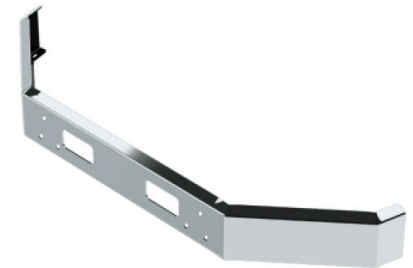

**LST SET BACK AXLE YEARS 1988-1995**

CHECK 'BF' SERIES PRIOR TO ORDERING

**BG**



BG-0000-29



BG-0010-29

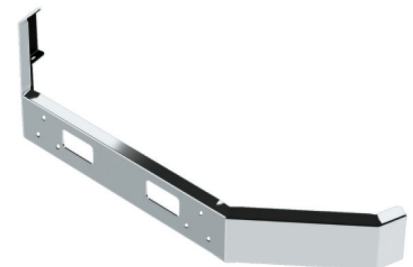

# FORD BUMPERS

AVAILABLE STYLES FOR PRODUCTS ON THIS PAGE:



Width  
13"  
16"  
18"  
\*20"

End Style  
Code

15
16
17
34

\* No warranty for 20" width

## BI

### F-650 SUPER DUTY YEARS 2005-2018

WITH CUMMINS 5.9L ENGINES

MOUNTING BRACKETS INCLUDED

CHECK 'BJ' SERIES PRIOR TO ORDERING

NOTE LETTERS 'BI' IN PART NUMBER

7.62"



BI-0011-15



BI-0010-15



BI-0001-15

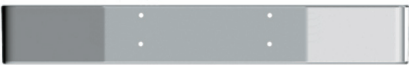

BI-0000-15



BI-0011-15

## BJ

### F-650 SUPER DUTY YEARS 2005-2018

WITH CATERPILLAR C7 ENGINES

MOUNTING BRACKETS INCLUDED

CHECK 'BI' SERIES PRIOR TO ORDERING

14.25"



BJ-0011-15

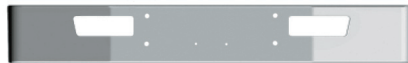

BJ-0010-15



BJ-0001-15



BJ-0000-15



BJ-0011-15

# FREIGHTLINER BUMPERS

EXAMPLE STYLES FOR PRODUCTS ON THIS PAGE:

Width	End Style Code	Width	End Style Code	Width	End Style Code
12"	01	12"	09	12"	04
16"	02	16"	10	16"	05
18"	03	18"	11	18"	06
20"	31	20"	51	20"	41
22"	32	22"	52	22"	42

## CABOVER AND CONVENTIONAL

YEARS 1980-1984

### CA



CA-1110-02



CA-1100-02



CA-1010-02



CA-0110-02



CA-1000-02



CA-0100-02



CA-0010-02



CA-0000-02

## CABOVER AND CONVENTIONAL AND CLASSIC

YEARS 1984-1999

### CB

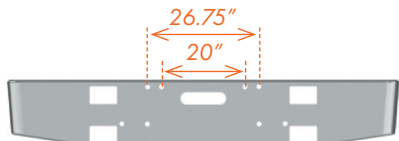

CB-2110-02



CB-2100-02



CB-2010-02



CB-0110-02



CB-2000-02



CB-0100-02



CB-0010-02

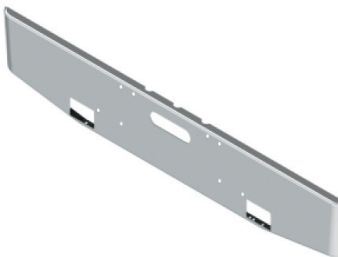

CB-0000-02



VF120009  
FL-TOW PIN COVER -CLASSIC  
FITS 'CA' & 'CB' SERIES BUMPERS



CB-2010-02

# FREIGHTLINER BUMPERS

EXAMPLE STYLES FOR PRODUCTS ON THIS PAGE:

End Style Code	Width	End Style Code	Width	End Style Code	Width	End Style Code
01	12"	09	12"	04	12"	04
02	16"	10	16"	05	16"	05
03	18"	11	18"	06	18"	06
31	20"	51	20"	41	20"	41
32	22"	52	22"	42	22"	42

**CQ**

26.75"  
20"

## FLD CLASSIC YEARS 2000-2002



CQ-2110-02



CQ-2100-02



CQ-2010-02



CQ-0110-02



CQ-2000-02

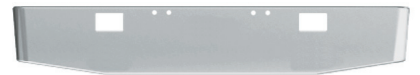

CQ-0100-02



CQ-0010-02



CQ-2010-02



CQ-0000-02

**CS**

28.12"

## FLD CLASSIC - 1200 SERIES YEARS 2002-2007



CS-2110-02



CS-2100-02



CS-2010-02



CS-0110-02



CS-2000-02



CS-0100-02



CS-0010-02



VF120009  
FL-TOW PIN COVER -CLASSIC  
FITS 'CQ' & 'CS' & 'CU' SERIES BUMPERS



CS-0000-02

**CU**

26.5"  
18.88"

## FLD CLASSIC - 1400 SERIES YEARS 2002-2007

ALSO CHECK 'CV' SERIES



CU-2110-02



CU-2100-02



CU-2010-02



CU-0110-02



CU-2000-02



CU-0100-02



CU-0010-02



CU-2110-02

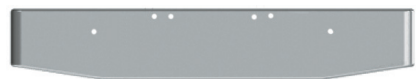

CU-0000-02

5.13"

# FREIGHTLINER BUMPERS

EXAMPLE STYLES FOR PRODUCTS ON THIS PAGE:

End Style Code	Width	End Style Code	Width	End Style Code	Width	End Style Code	Width
01	12"	09	12"	04	12"	04	12"
02	16"	10	16"	05	16"	05	16"
03	18"	11	18"	06	18"	06	18"
31	20"	51	20"	41	20"	41	20"
32	22"	52	22"	42	22"	42	22"

## FLD CLASSIC YEARS 2002-2007 ALSO CHECK 'CU' SERIES

**CV**

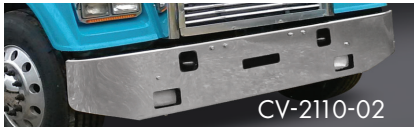
CV-2110-02	CV-2100-02	CV-2100-02
CV-0110-02	CV-2000-02	CV-0100-02
CV-0010-02		CV-0000-02

## FLD CLASSIC YEARS 2008-2010 ONLY AVAILABLE IN 16" AND WIDER

**CX**

CX-2110-02		CX-2100-02
CX-0110-02	CX-2100-02	CX-0100-02
CX-0010-02	CX-2000-02	CX-0000-02

## 114SD SET FORWARD AXLE YEARS 2012-NEWER

NOTE LETTERS "COI" IN PART NUMBER

**COI**

COI-2111-02	COI-2100-02	COI-2001-02
COI-0011-02	COI-2000-02	COI-0010-02
COI-0001-02		COI-0000-02

# FREIGHTLINER BUMPERS

AVAILABLE STYLES FOR PRODUCTS ON THIS PAGE:

CZ			TAPER ROLLED END			SQUARE ROLLED END		
Width	End Style Code		Width	End Style Code		Width	End Style Code	
19"	707	GULLWING	12"	01		12"	04	
			16"	02		16"	05	
			18"	03		18"	06	
			20"	31		20"	41	
			22"	32		22"	42	

## CZ

**CORONADO YEARS 2002-2009 & GLIDER CHASSIS**  
 DOES NOT USE FACTORY SUPPORT BRACKETS OR ENDS CAPS



## COC

**CORONADO 122SD SET FORWARD YEARS 2010-NEWER**  
 16" AND WIDER (SEE 'COE' SERIES FOR 12" BUMPERS)

NOTE LETTERS "COC" IN PART NUMBER



## COE

**CORONADO 122SD SET FORWARD YEARS 2010-NEWER**  
 12" WIDE (SEE 'COC' SERIES FOR 16" AND WIDER BUMPERS)

NOTE LETTERS "COE" IN PART NUMBER



# FREIGHTLINER BUMPERS

AVAILABLE STYLES FOR PRODUCTS ON THIS PAGE:



Width	End Style Code
12"	04
16"	95
18"	96
20"	97

\* No warranty for 20" width

## FLC112 SETBACK AXLE YEARS 1986-1995

**CC**

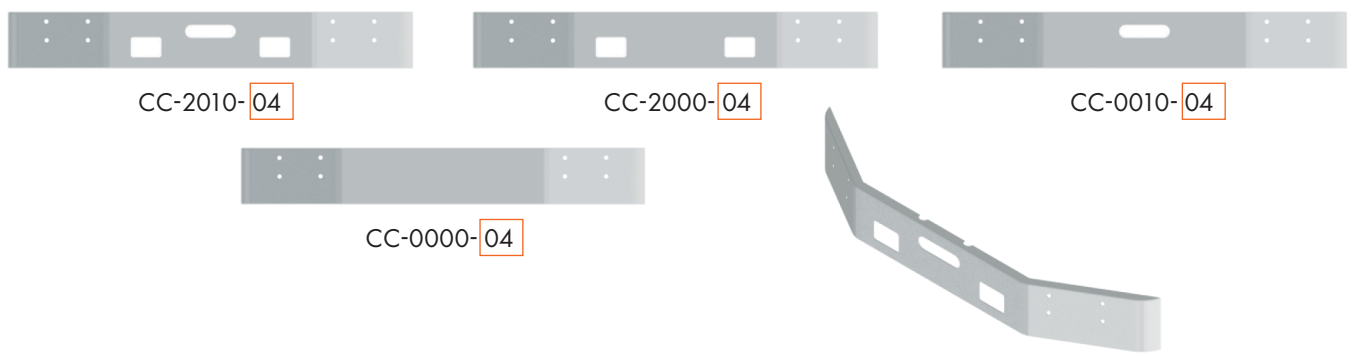

## FLC120 SETBACK AXLE YEARS 1986-1995

**CD**

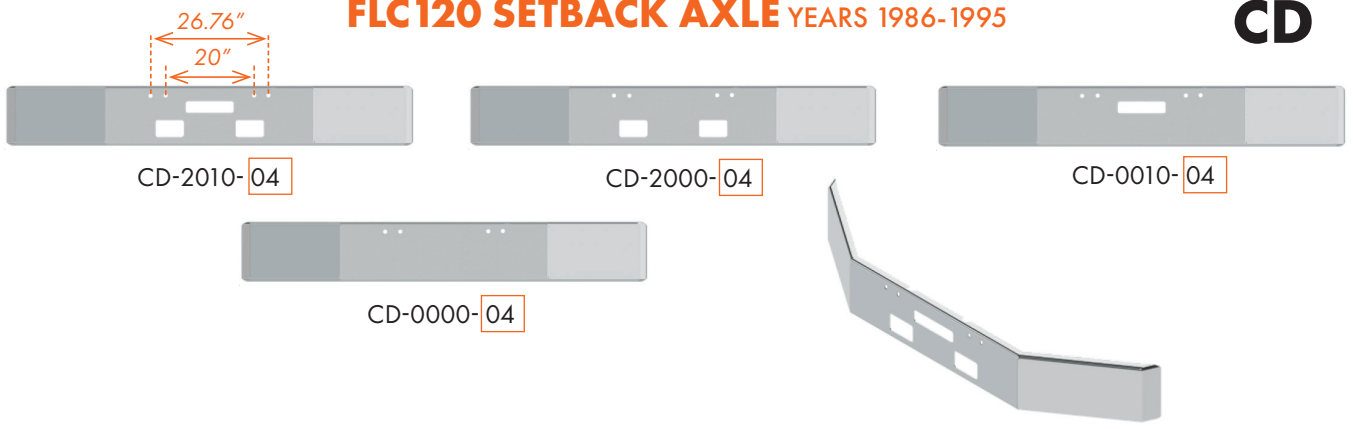

## FLD 112SD SETBACK AXLE YEARS 1989-1996

**CP**

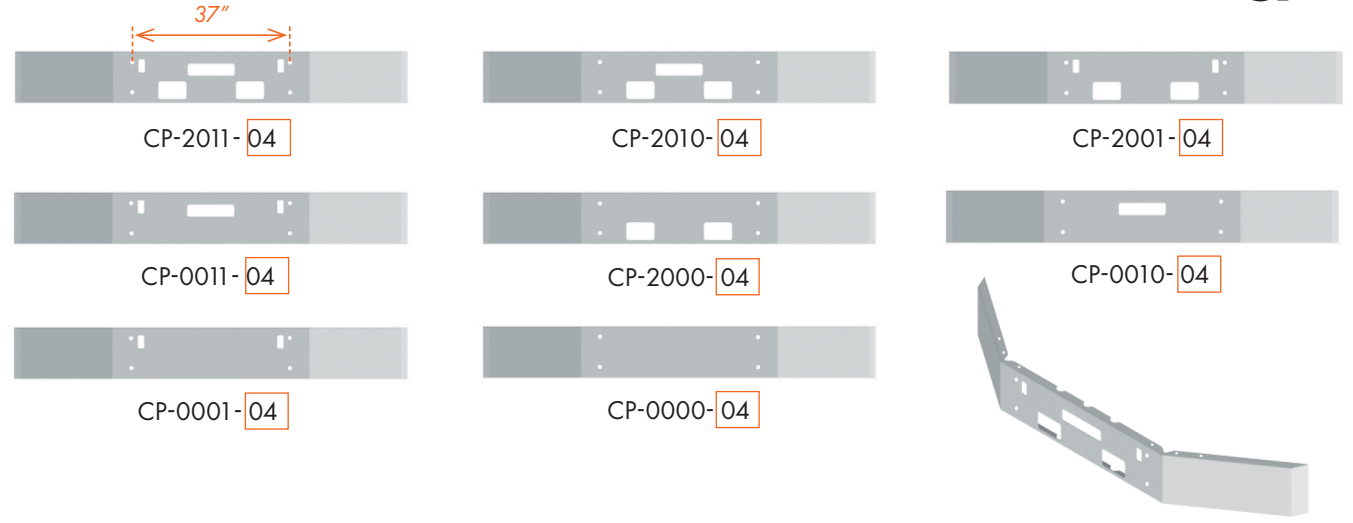

# FREIGHTLINER BUMPERS

AVAILABLE STYLES FOR PRODUCTS ON THIS PAGE:

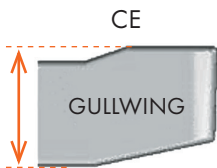
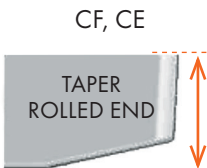
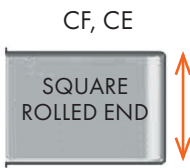
CE	Width	End Style Code	CF, CE	Width	End Style Code	CF, CE	Width	End Style Code
	16"	07		12"	01		12"	04
				16"	02		16"	05
				18"	03		18"	06
				20"	31		20"	41
				22"	32		22"	42

## CF

**CABOVER WITH 7 INCH BREAKBACK, YEARS 1989-1995**

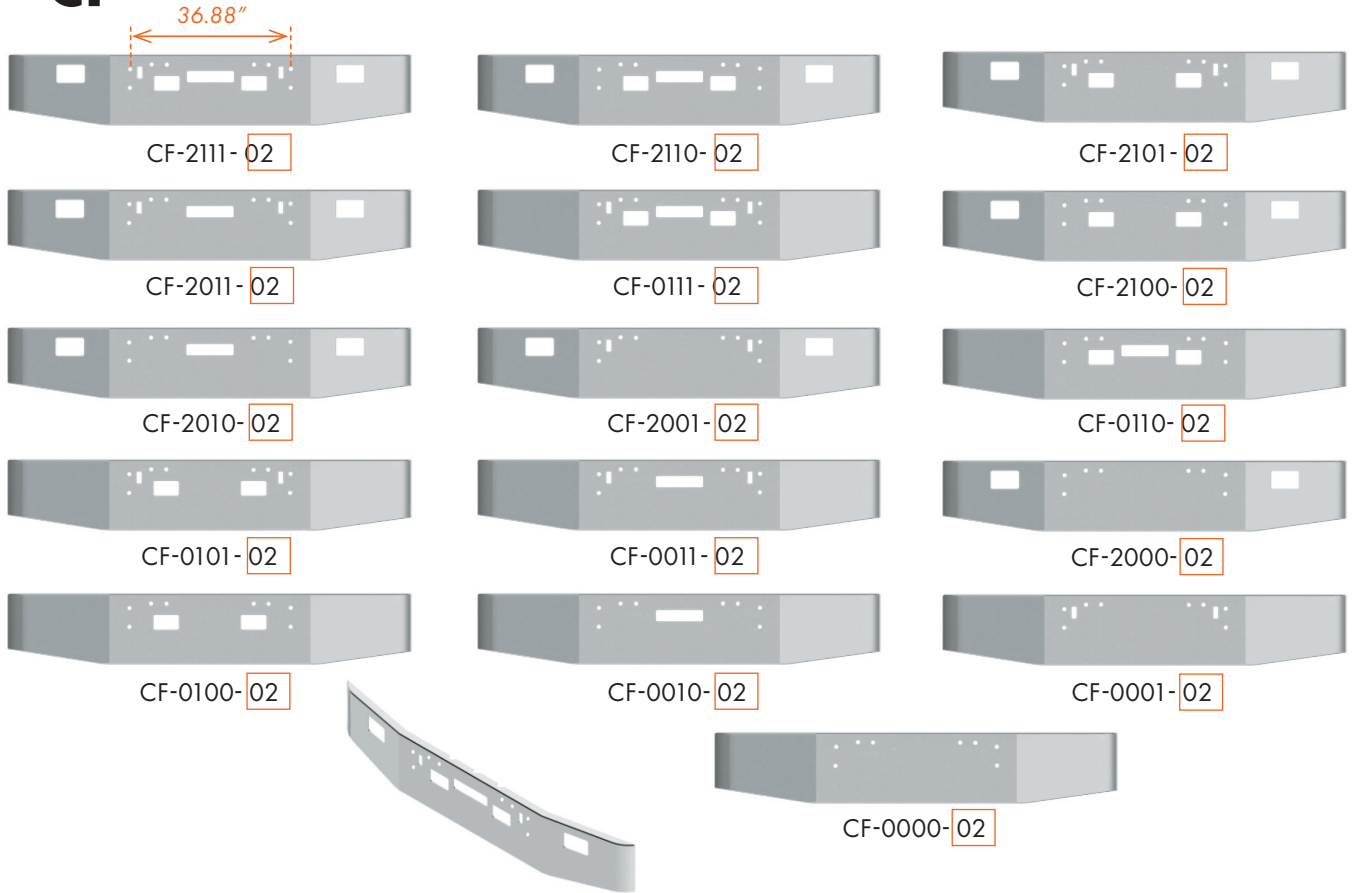

## CE

**FLC112 CONVENTIONAL, YEARS 1986-1995**  
**STEEL CAB MUST USE GULLWING STYLE -07 ONLY**





# FREIGHTLINER BUMPERS

AVAILABLE STYLES FOR PRODUCTS ON THIS PAGE:



Width	End Style Code
12"	04
16"	95
18"	96
20"	97

\* No warranty for 20" width

FOR 92-INCH LONG BUMPERS WITHOUT PLASTIC END CAPS, ADD "92" TO END OF PART NUMBER.  
EXAMPLE: CG-2011-04-"92"

**FLD 112** WITH 6 INCH BREAKBACK, YEARS 1989-1996  
86.75" LONG STANDARD. PLASTIC ENDS NOT INCLUDED.

**CG**

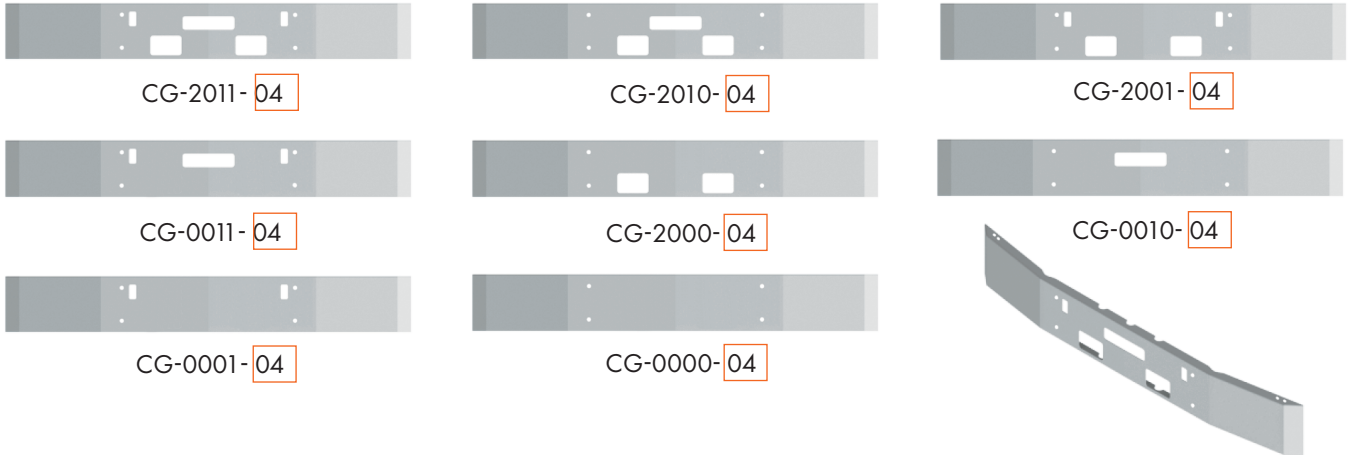

**FLD 120** WITH 6 INCH BREAKBACK, YEARS 1989-1996  
86.75" LONG STANDARD. PLASTIC ENDS NOT INCLUDED (ALSO SEE 'CJ' SERIES).

**CH**

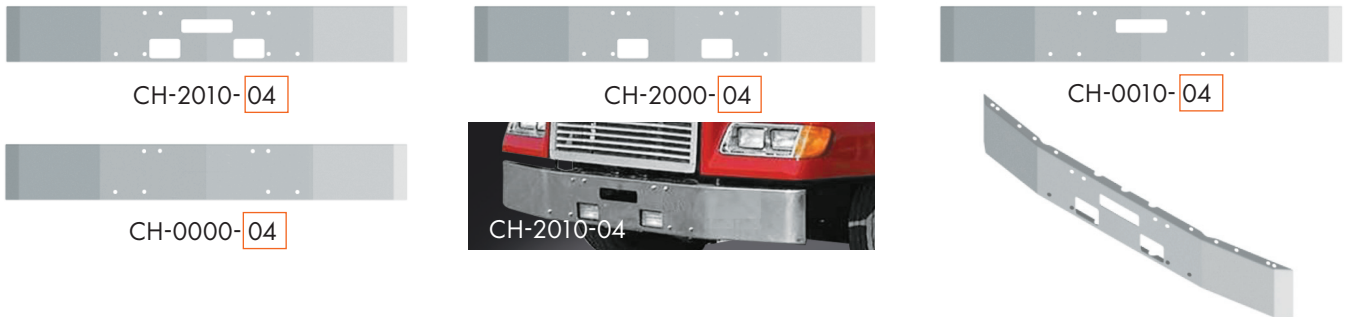

**FLD 120** WITH 6 INCH BREAKBACK, YEARS 1989-1996  
86.75" LONG STANDARD. PLASTIC ENDS NOT INCLUDED (ALSO SEE 'CH' SERIES).

**CJ**

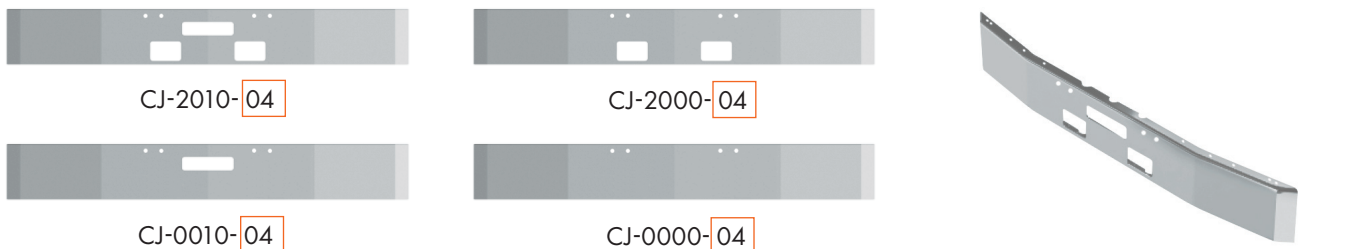

# FREIGHTLINER BUMPERS

AVAILABLE STYLES FOR PRODUCTS ON THIS PAGE:

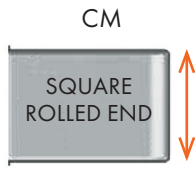

Width	End Style Code
12"	04
16"	95
18"	96
20"	97

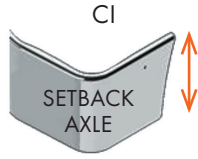

Width	End Style Code
12"	15
16"	16
18"	17
*20"	34

\* No warranty for 20" width

FOR 92 INCH LONG CM SERIES BUMPERS WITHOUT PLASTIC END CAPS, ADD "92" TO END OF PART NUMBER . EXAMPLE : CM-2011-04-"92"

## CM

**FLD 112 & FLD 120** WITH 6-INCH BREAKBACK, YEARS 1989-1996  
 86.75" LONG STANDARD. PLASTIC ENDS NOT INCLUDED.  
 COMBO BOLT PATTERN

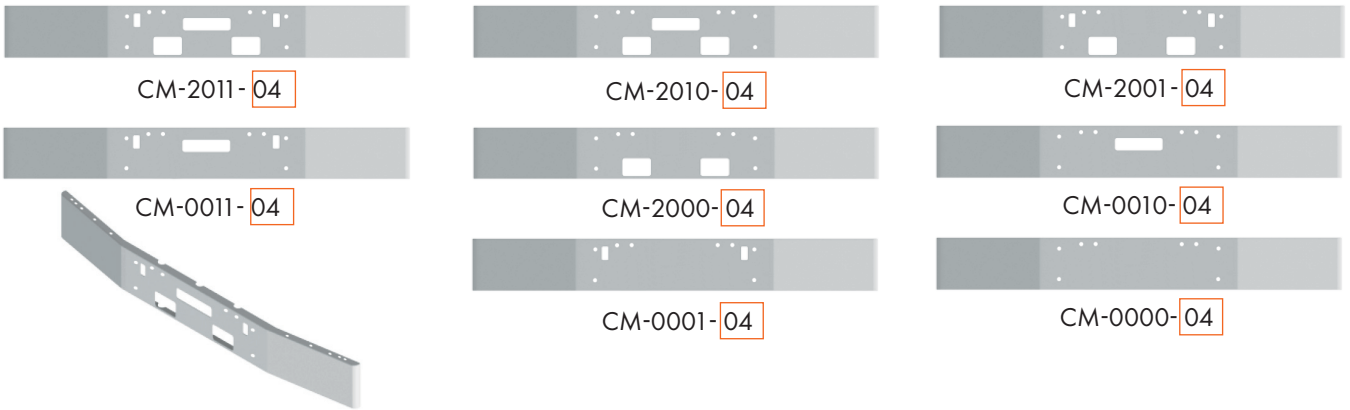

## CI

**FLD 112 & FLD 120 SETBACK** FULL WRAP. METAL BUMPER, YEARS 1989-2006  
 COMBO BOLT PATTERN, NOTE LETTERS 'CI' IN PART NUMBER

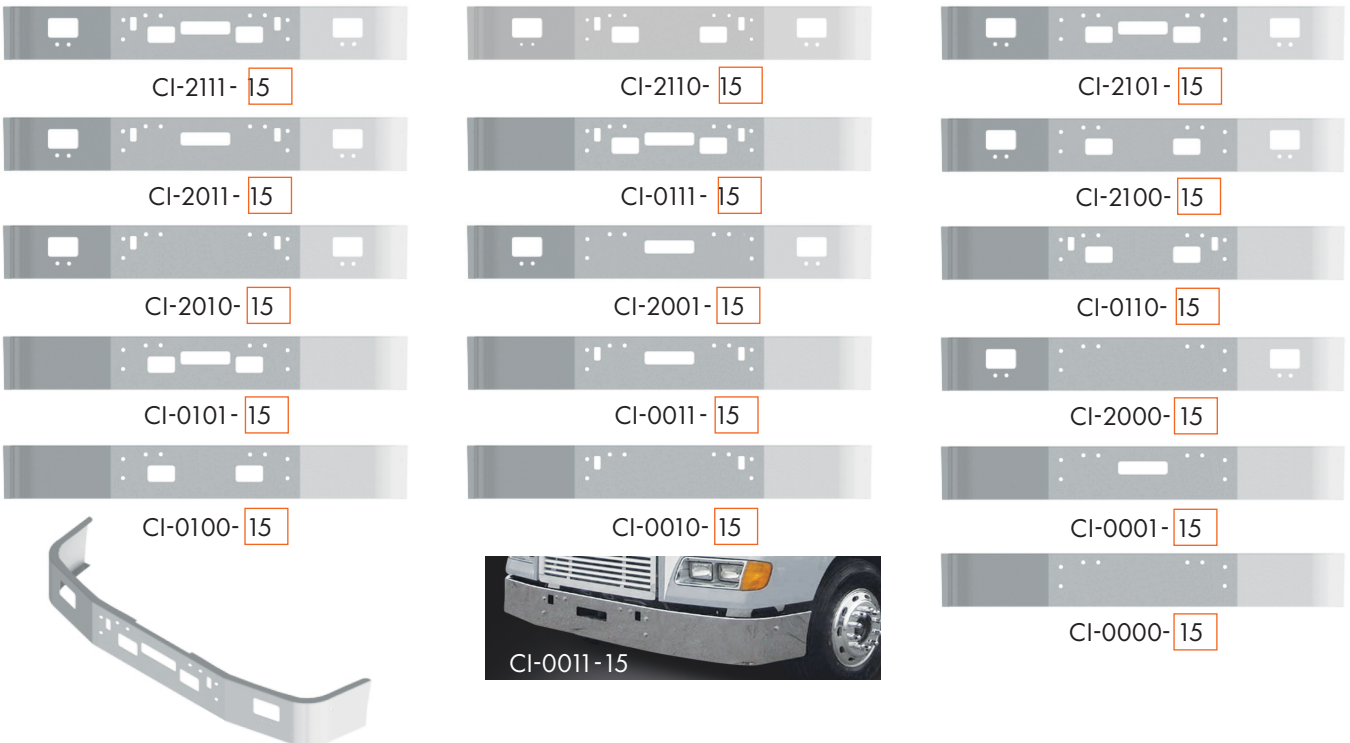

# FREIGHTLINER BUMPERS

AVAILABLE STYLES FOR PRODUCTS ON THIS PAGE:



SETBACK AXLE

Width	End Style Code
14"	15
16"	16
18"	17
*20"	34

\* No warranty for 20" width

## CENTURY SETBACK AXLE, YEARS 1996-2004 MOUNTING BRACKETS INCLUDED

### CL



CL-2210-15



CL-2200-15



CL-2010-15



CL-0210-15



CL-0210-15



CL-0200-15



CL-0010-15

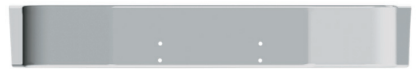
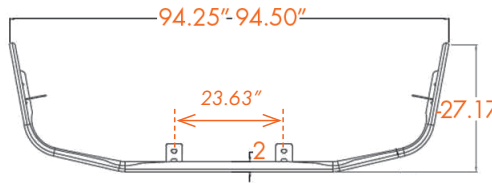

CL-0000-15

## COLUMBIA SETBACK AXLE, YEARS 1999-2007

### CW

## CENTURY SETBACK AXLE, YEARS 2005-2007 MOUNTING BRACKETS INCLUDED

ALSO FITS NEWER MODEL GLIDERS - CHECK CHASSIS CONFIGURATION



CW-1011-15



CW-2011-15



CW-0011-15



CW-1010-15



CW-2010-15



CW-0010-15



CW-0000-15



CW-2000-15



CW-0001-15

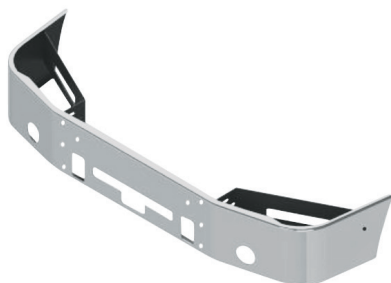

CW-0011-15

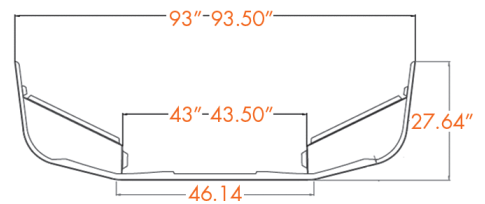

# FREIGHTLINER BUMPERS

AVAILABLE STYLES FOR PRODUCTS ON THIS PAGE:



Width	End Style Code
18"	17
*20"	34

\* No warranty for 20" width

## COA

**COLUMBIA** SETBACK AXLE, YEARS 2008 & NEWER  
REPLACES STEEL CENTER/PLASTIC ENDS BUMPERS ONLY  
 MOUNTING BRACKETS INCLUDED

NOTE LETTERS 'COA' IN PART NUMBER. FOR 2008 & NEWER GLIDERS SEE CW SERIES.



COA-1011-17



COA-2011-17



COA-0011-17



COA-1010-17



COA-2010-17



COA-0010-17



COA-0000-17



COA-2000-17



COA-0001-17

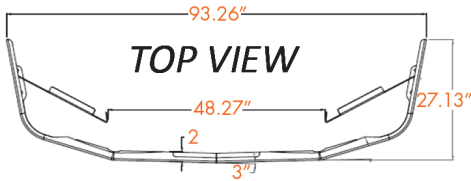

## COB

**COLUMBIA** SETBACK AXLE, YEARS 2008 & NEWER

**CENTURY** SETBACK AXLE, YEARS 2008 & NEWER  
REPLACES STAINLESS CLAD BUMPERS ONLY

MOUNTING BRACKETS INCLUDED. NOTE LETTERS 'COB' IN PART NUMBER.



COB-1011-17



COB-2011-17



COB-0011-17



COB-1010-17



COB-2010-17



COB-0010-17



COB-0000-17



COB-0001-17



COB-0001-17

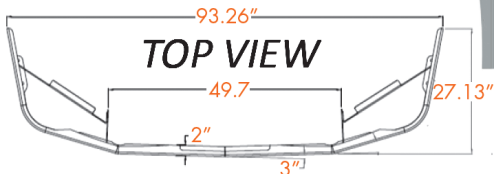

# FREIGHTLINER BUMPERS

AVAILABLE STYLES FOR PRODUCTS ON THIS PAGE:

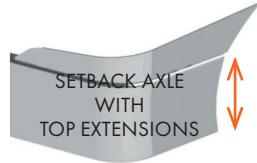

Width	End Style Code
14"	15X
16"	16X
18"	17X
*20"	34X

\* No warranty for 20" width

## CASCADIA "P3" YEARS 2008-2017

REPLACES PLASTIC BUMPERS ONLY

STANDARD WIDTH RADIATOR TRUCKS ONLY

MOUNTING BRACKETS AND EXTENSIONS INCLUDED

SEE 'COH' SERIES FOR REPLACING P3 STAINLESS CLAD

SEE 'COJ' AND 'COK' SERIES FOR NEWER P4 BUMPERS

**CY**



CY-5011-15X

2 OEM fogs, tow pins, vent  
No radar



CY-2011-15X

2 rect. fogs, tow pins, vent  
No radar



CY-5012-15X

2 OEM fogs, tow pins, vent  
Accommodates radar



CY-0011-15X

Tow pins, vent, no radar



CY-0012-15X

Tow pins, vent  
Accommodates radar



CY-0000-15X

No cutouts, mounting only



CY-0010-15X

Tow pins



CY-5011-15X

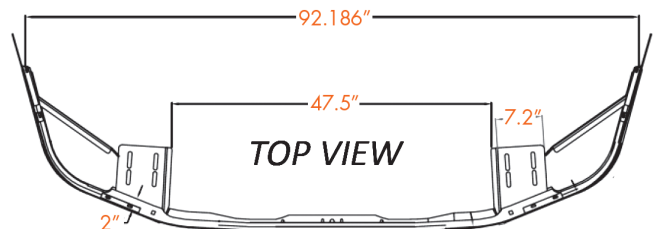

# FREIGHTLINER BUMPERS

AVAILABLE STYLES FOR PRODUCTS ON THIS PAGE:

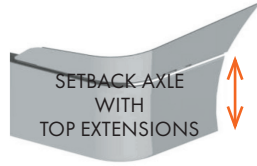

Width	End Style Code
14"	15X
* 16"	16X

\* 16" bumpers require customer to shim brackets

## COH

### CASCADIA "P3" YEARS 2008-2017

REPLACES STAINLESS CLAD BUMPERS ONLY

STANDARD WIDTH RADIATOR TRUCKS ONLY

EXTENSIONS INCLUDED, MOUNTING BRACKETS NOT INCLUDED

MOUNTS TO EXISTING CLAD BUMPER BRACKETS

SEE 'CY' SERIES FOR REPLACING P3 PLASTIC BUMPERS

SEE 'COJ' AND 'COK' SERIES FOR NEWER P4 BUMPERS

NOTE LETTERS 'COH' IN PART NUMBER



COH-5011-15X  
2 OEM fogs, tow pins, vent  
No radar



COH-5012-15X  
2 OEM fogs, tow pins, vent  
Accommodates radar

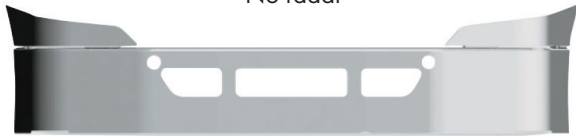

COH-0011-15X  
Tow pins, vent, no radar



COH-0012-15X  
Tow pins, vent  
Accommodates radar



COH-0000-15X  
No cutouts, mounting only



COH-0010-15X  
Tow pins

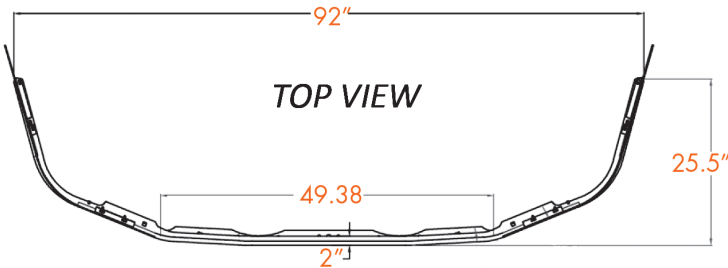

# FREIGHTLINER BUMPERS

AVAILABLE STYLES FOR PRODUCTS ON THIS PAGE:

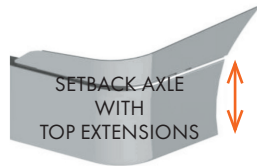

Width	End Style Code
14"	15Z
16"	16Z
18"	17Z
*20"	34Z

\* No warranty for 20" wide bumpers

## CASCADIA "P4" YEARS 2017 & NEWER

# COJ

REPLACES PLASTIC BUMPERS ONLY

STANDARD WIDTH RADIATOR TRUCKS ONLY

MOUNTING BRACKETS INCLUDED

NOTE LETTERS 'COJ' IN PART NUMBER

SEE 'COK' SERIES IF REPLACING STAINLESS CLAD BUMPERS



COJ-5011-15Z-V6

2 OEM fogs, tow pins, vent, radar  
Radar requires plastic cover

TO TOP OF RADAR HOLE



COJ-5010-15Z-V6

2 OEM fogs, tow pins, radar  
Radar requires plastic cover



COJ-2010-15Z-V6

2 rectangular aftermarket fogs, tow pins, radar  
Radar requires plastic cover



COJ-5010-15Z

2 OEM fogs, tow pins



COJ-0010-15Z-V6

Tow pins, radar  
Radar requires plastic cover



COJ-0011-15Z

Tow pins, vent

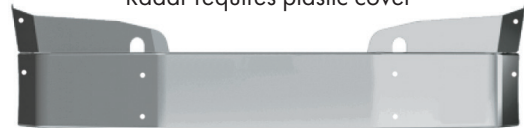

COJ-0010-15Z

Tow pins



COJ-5011-15Z-V6

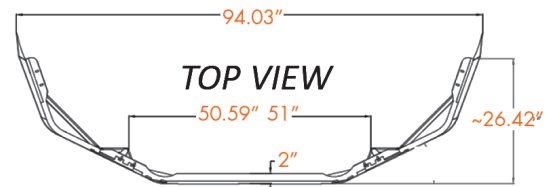

TOP VIEW

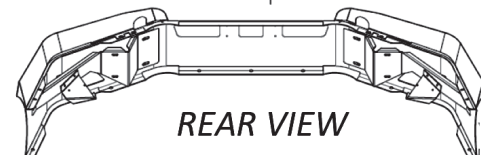

REAR VIEW

# FREIGHTLINER BUMPERS

AVAILABLE STYLES FOR PRODUCTS ON THIS PAGE:

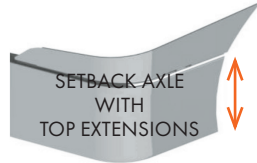

Width	End Style Code
14"	15Z
16"	16Z
18"	17Z
*20"	34Z

\* No warranty for 20" wide bumpers

## COK

### CASCADIA "P4" YEARS 2017 & NEWER

REPLACES STAINLESS CLAD BUMPERS ONLY

STANDARD WIDTH RADIATOR TRUCKS ONLY

MOUNTING BRACKETS INCLUDED

NOTE LETTERS 'COK' IN PART NUMBER

SEE 'COJ' SERIES IF REPLACING PLASTIC BUMPERS



COK-5011-15Z-V6

2 OEM fogs, tow pins, vent, radar  
Radar requires plastic cover

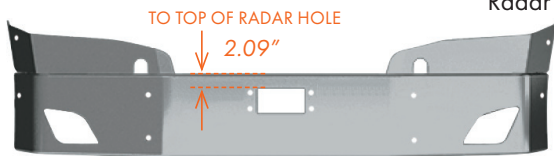

TO TOP OF RADAR HOLE  
2.09"

COK-5010-15Z-V6

2 OEM fogs, tow pins, radar  
Radar requires plastic cover



COK-2010-15Z-V6

2 rectangular aftermarket fogs, tow pins, radar  
Radar requires plastic cover

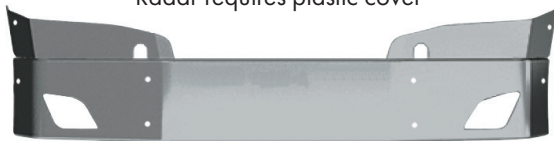

COK-5010-15Z

2 OEM fogs, tow pins



COK-0010-15Z-V6

Tow pins, radar  
Radar requires plastic cover



COK-0011-15Z

Tow pins, vent

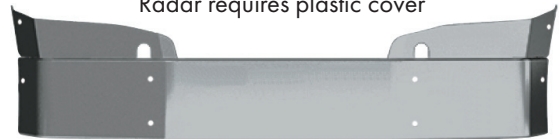

COK-0010-15Z

Tow pins



COK-5011-15Z-V6

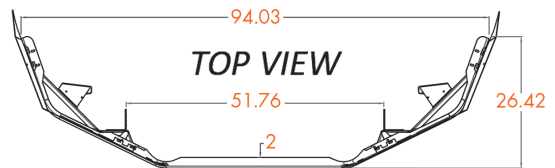

TOP VIEW

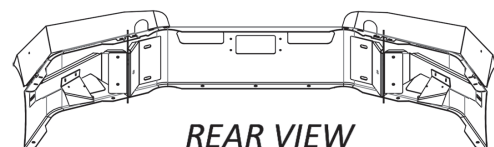

REAR VIEW



# FREIGHTLINER BUMPERS

AVAILABLE STYLES FOR PRODUCTS ON THIS PAGE:



Width	End Style Code
12"	15
16"	16
18"	17
*20"	34

\*No warranty for 20" wide bumpers

## FL SERIES MEDIUM DUTY YEARS 2002 & OLDER

# CK

FL50, FL60, FL70, FL80  
MOUNTS TO FACTORY BRACKETS  
ALSO CHECK 'CR' SERIES



CK-0220-15



CK-0020-15



CK-0200-15

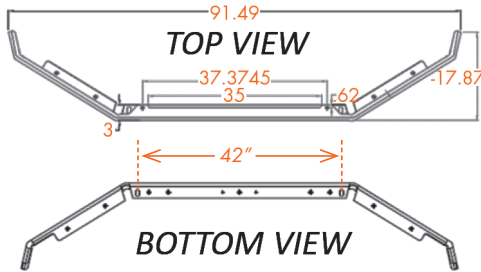

CK-0000-15

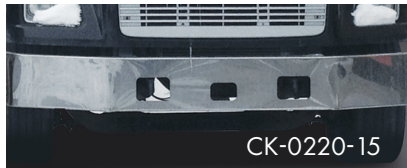

CK-0220-15

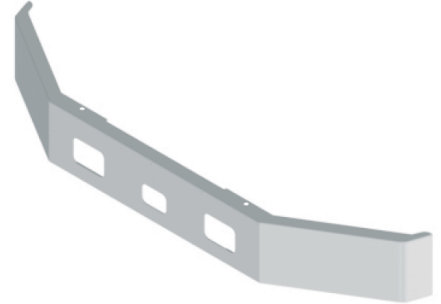

## FL112 SERIES MEDIUM DUTY YEARS 2002 & OLDER

# CR

MOUNTS TO FACTORY BRACKETS  
ALSO CHECK 'CK' SERIES



CR-0220-15



CR-0020-15



CR-0200-15

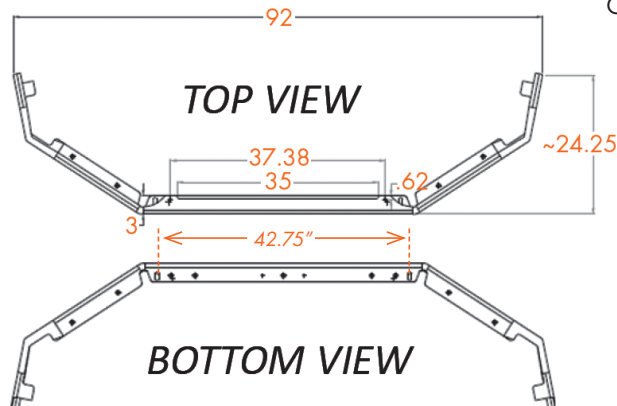

CR-0000-15

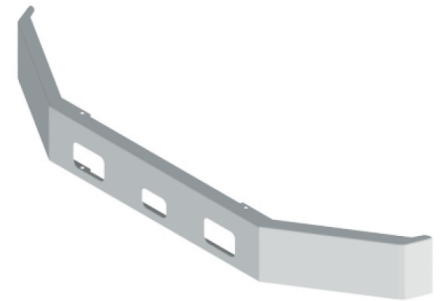

# FREIGHTLINER BUMPERS

AVAILABLE STYLES FOR PRODUCTS ON THIS PAGE:

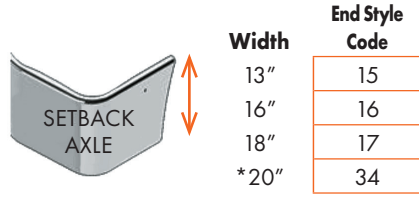

\* No warranty for 20" wide bumpers

## CT

**M2 106 BUSINESS CLASS** YEARS 2003 & NEWER  
 FLUSH TOP FLANGE MOUNT. INCLUDES UPPER LICENSE PLATE HOLES.  
 ALSO CHECK 'COG' SERIES

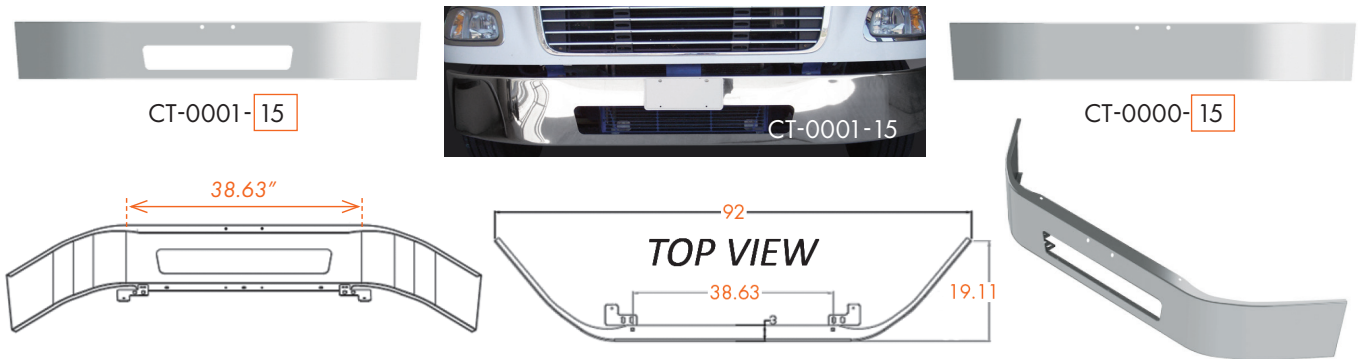

## COF

**M2 112 BUSINESS CLASS** YEARS 2003 & NEWER  
 TOP FLANGE MOUNT ON INTEGRATED GUSSETS. INCLUDES UPPER LICENSE PLATE HOLES.  
 NOTE LETTERS 'COF' IN PART NUMBER

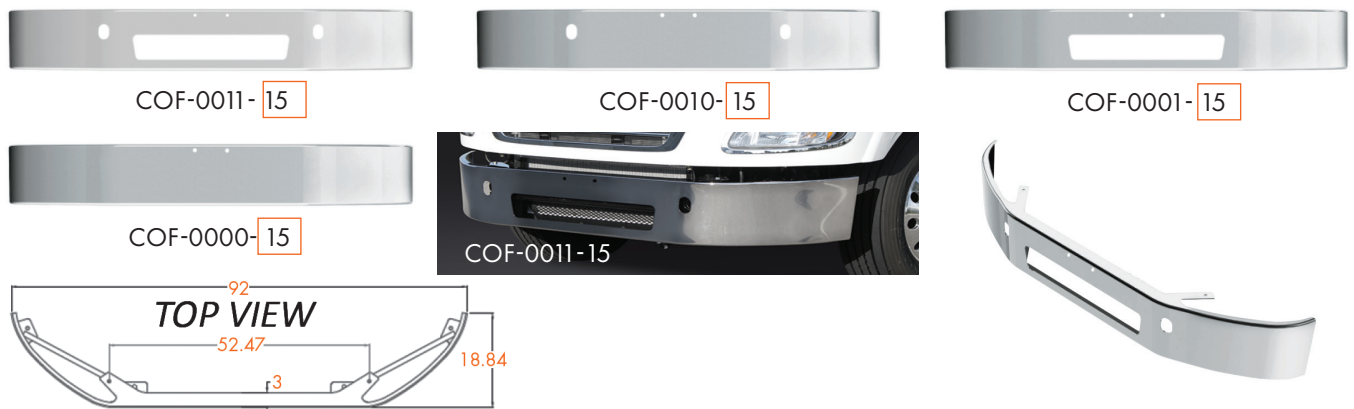

## COG

**M2 106 BUSINESS CLASS** YEARS 2011 & NEWER  
 RECESSED TOP FLANGE MOUNT, BRACKETS INCLUDED  
 NOTE LETTERS 'COG' IN PART NUMBER  
 CHECK 'CT' SERIES PRIOR TO ORDERING

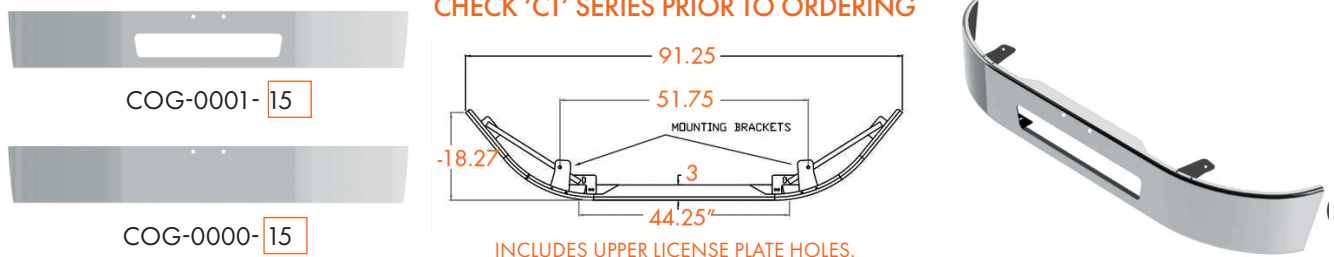

INCLUDES UPPER LICENSE PLATE HOLES.

# GMC BUMPERS

EXAMPLE STYLES FOR PRODUCTS ON THIS PAGE:

Width	End Style Code	Width	End Style Code	Width	End Style Code
12"	01	12"	09	12"	04
16"	02	16"	10	16"	05
18"	03	18"	11	18"	06
20"	31	20"	51	20"	41
22"	32	22"	52	22"	42

**GENERAL YEARS 1977-1987**

DB

DB-1001-02	DB-1000-02
DB-0001-02	DB-0000-02

**BRIGADIER YEARS 1978-1988**

DC

DC-1001-02	DC-1000-02
DC-0001-02	DC-0000-02

**BRIGADIER HIGH CAB YEARS 1978-1988**

DD

DD-1001-02	DD-1000-02
DD-0001-02	DD-0000-02

**ASTRO YEARS 1982-1987, NOT AVAILABLE IN 12" WIDTH**

DE

DE-1011-02	DE-1010-02	DE-1001-02
DE-0011-02	DE-1000-02	DE-0010-02
DE-0001-02		DE-0000-02

# GMC BUMPERS

AVAILABLE STYLES FOR PRODUCTS ON THIS PAGE:



## DH

**GMC 7000/CHEVY C60, C65, C70** YEARS 1981-1988

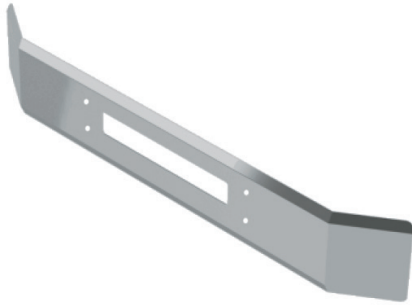

DH-0001-12



DH-0000-12

## DF

**GMC TOPKICK/CHEVY KODIAK** YEARS 1989-1990

NOT AVAILABLE IN 7-GAUGE STEEL OR STAINLESS STEEL

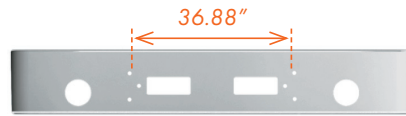
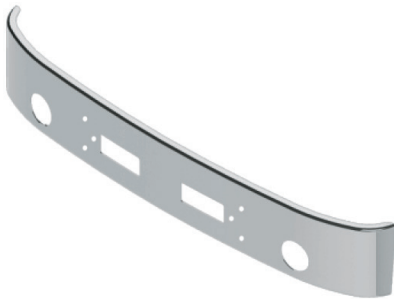

DF-1001-38



DF-1000-38



DF-0001-38



DF-0000-38

## DG

**GMC TOPKICK/CHEVY KODIAK** YEARS 1990-2003

C5500, C6500

NOT AVAILABLE IN 7-GAUGE STEEL OR STAINLESS STEEL

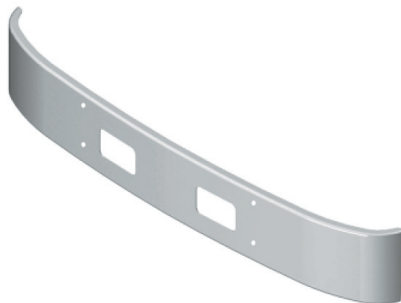

DG-1001-38



DG-1000-38



DG-0001-38



DG-0000-38

# GMC BUMPERS

AVAILABLE STYLES FOR PRODUCTS ON THIS PAGE:



Width	End Style Code
14"	15
16"	16
18"	17

**C4500, C5500 YEARS 2004-2006**  
 NOTE LETTERS 'DI' IN PART NUMBER  
 INCLUDES UPPER LICENSE PLATE HOLES.

**DI**

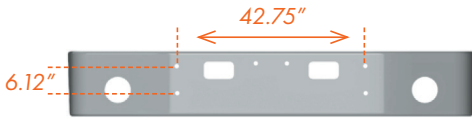

DI-1001-15



DI-0001-15



DI-1000-15



DI-0000-15

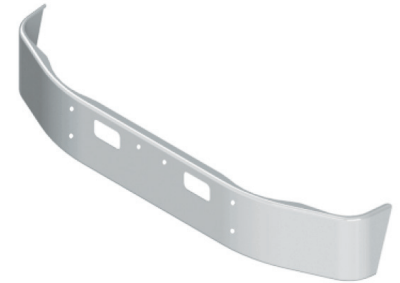

DI-0001-15

**C6500, C7500 YEARS 2004-2009**  
 INCLUDES UPPER LICENSE PLATE HOLES.

**DJ**

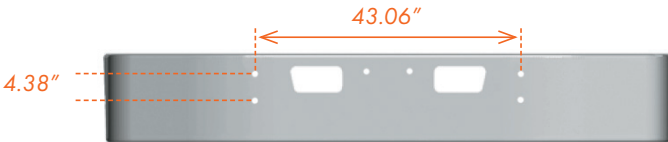

DJ-0001-15



DJ-0000-15

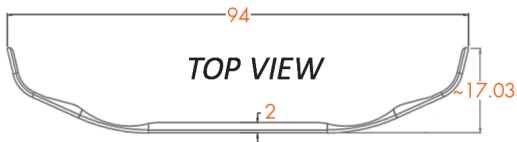

DJ-0001-15



# HINO BUMPERS

AVAILABLE STYLES FOR PRODUCTS ON THIS PAGE:



Width	End Style Code
14"	15
16"	16
18"	17
*20"	34

\* No warranty for 20" wide bumpers

## OA

**268, 338 YEARS 2004 & NEWER**  
**MOUNTING BRACKETS INCLUDED**  
**NOTE LETTERS 'OA' IN PART NUMBER**  
**INCLUDES ONE SET UPPER LICENSE PLATE HOLES**



OA-0011-15



OA-0010-15



OA-0001-15



OA-0000-15

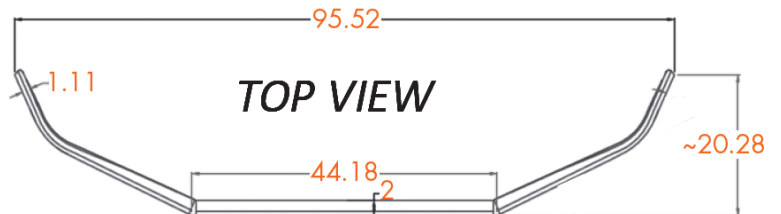
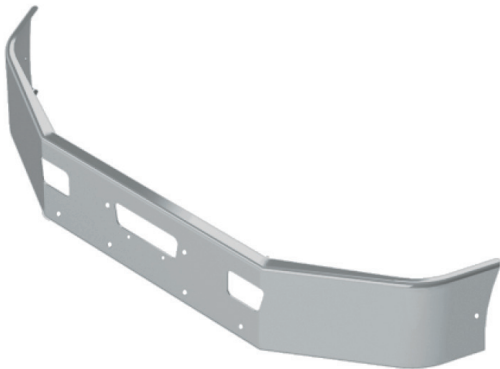

OA-0011-15



OA-0011-15P

Add "P" to end of any bumper part number for black powder coated steel

# INTERNATIONAL BUMPERS

EXAMPLE STYLES FOR PRODUCTS ON THIS PAGE:

Width	End Style Code	Width	End Style Code	Width	End Style Code
12"	01	12"	09	12"	04
16"	02	16"	10	16"	05
18"	03	18"	11	18"	06
20"	31	20"	51	20"	41
22"	32	22"	52	22"	42

## 4200, 4300 YEARS YEARS 1977-1990 CONVENTIONAL

### ED

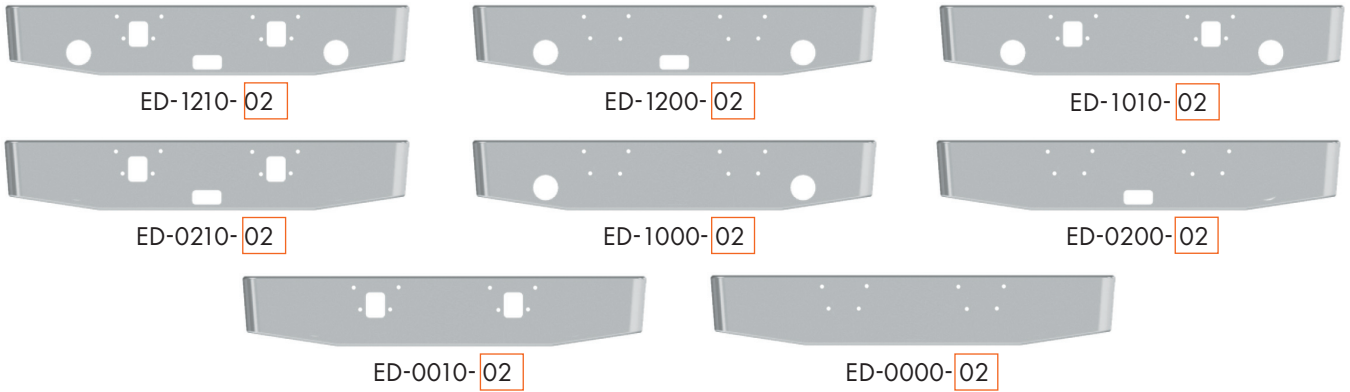

## 9300, 9370 CONVENTIONAL, 9670 CABOVER YEARS 1983-1996

### EI

SET FORWARD AXLE. SEE 'EJ' SERIES FOR SETBACK AXLE.  
NOTE LETTERS 'EI' IN PART NUMBER

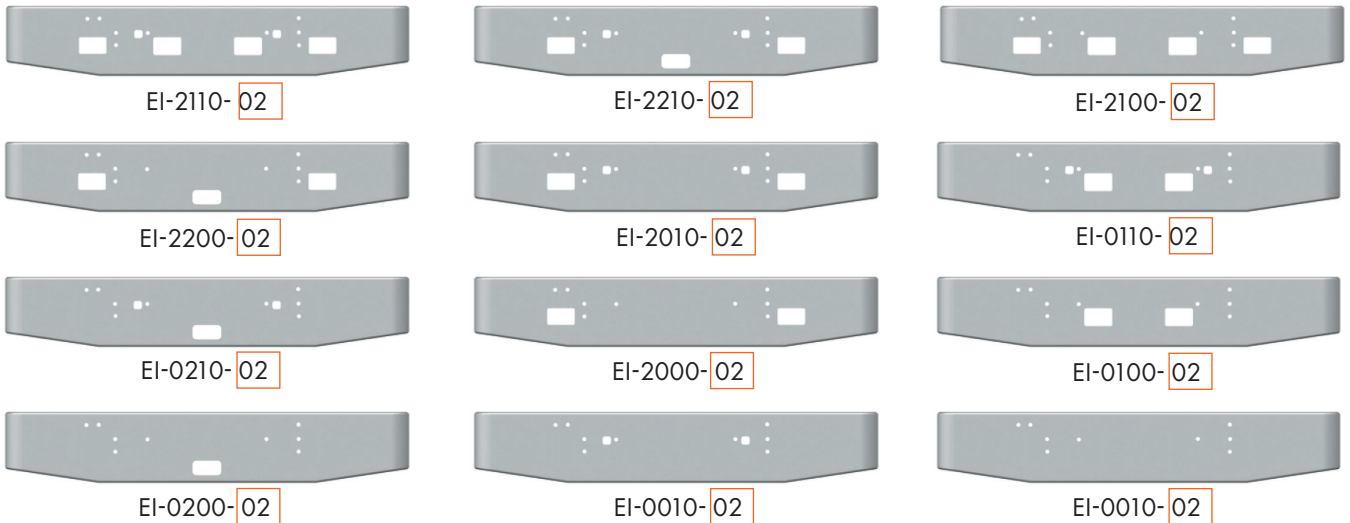

EI-0210-06

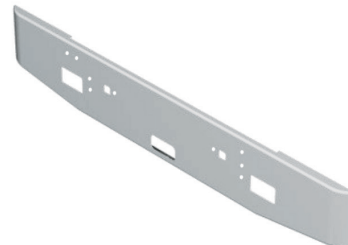

# INTERNATIONAL BUMPERS

AVAILABLE STYLES FOR PRODUCTS ON THIS PAGE:

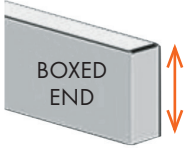
	Width	End Style Code		Width	End Style Code
 <p>SQUARE ROLLED END</p>	12"	04	 <p>BOXED END</p>	12"	09
	16"	05		16"	10
	18"	96		18"	11
	*20"	97		20"	51
	*22"	98		22"	52

\* No warranty for 20" wide bumpers

## EJ

### 9300 SERIES SET BACK AXLE YEARS 1983-1996

SEE 'EI' SERIES FOR SET FORWARD AXLE



EJ-2210-96



EJ-2000-96

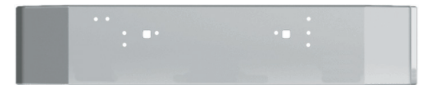

EJ-0010-96



EJ-0210-96



EJ-0200-96



EJ-0000-96



EJ-2010-96



EJ-2200-96

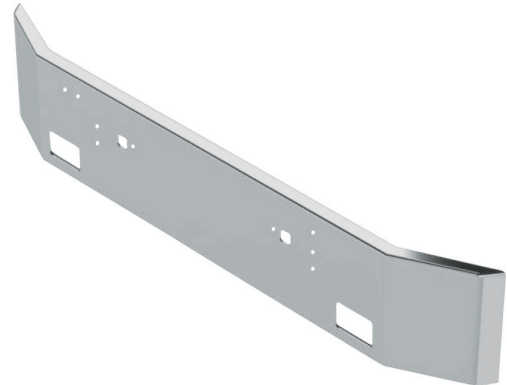



# INTERNATIONAL BUMPERS

EXAMPLE STYLES FOR PRODUCTS ON THIS PAGE:

End Style	Width	End Style Code	End Style	Width	End Style Code	End Style	Width	End Style Code
TAPER ROLLED END	12"	01	BOXED END	12"	09	SQUARE ROLLED END	12"	04
	16"	02		16"	10		16"	05
	18"	03		18"	11		18"	06
	20"	31		20"	51		20"	41
	22"	32		22"	52		22"	42

## 9900 YEARS 1998-1999

### EN

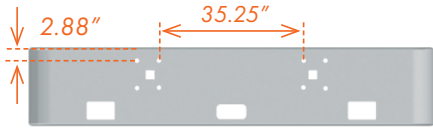

EN-2210-06



EN-2200-06

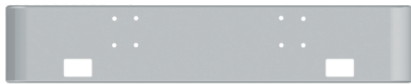

EN-2000-06



EN-0210-06



EN-0200-06



EN-0010-06



EN-2010-06



EN-0000-06

## 9900 YEARS 2000 & NEWER

### ER

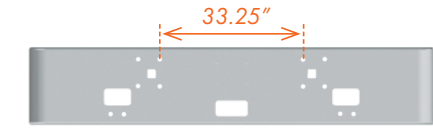

ER-2210-06



ER-2200-06



ER-2010-06

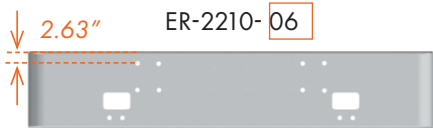

ER-2000-06



ER-0210-06



ER-0200-06

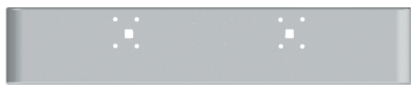

ER-0010-06



ER-0000-06

## 5900 SET FORWARD AXLE YEARS 2001-2011

### EW



EW-2010-02



EW-2020-02



EW-2030-02



EW-2000-02



EW-0010-02



EW-0020-02



EW-0030-02



EW-2010-02

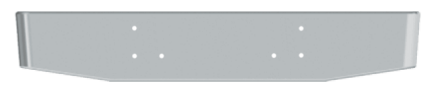

EW-0000-02

# INTERNATIONAL BUMPERS

AVAILABLE STYLES FOR PRODUCTS ON THIS PAGE:



## EF

**2200S, 2500S** YEARS 1977-1990

NOT AVAILABLE IN 10-GAUGE STEEL OR STAINLESS STEEL

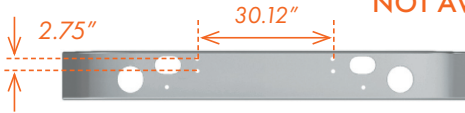

EF-1010-24



EF-1000-24



EF-0000-24

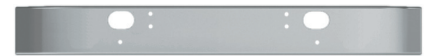

EF-0010-24

## EG

**1700S, 1800S 1900S** YEARS 1977-1990

NOT AVAILABLE IN 10-GAUGE STEEL OR STAINLESS STEEL

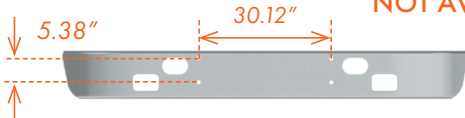

EG-2010-24

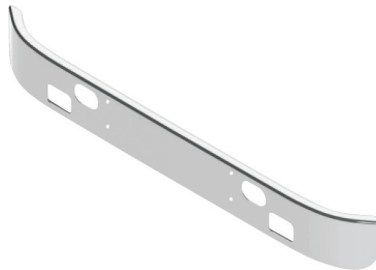

EG-2000-24

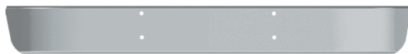

EG-0000-24



EG-0010-24

## EL

**4000 SERIES, 7000 SERIES, 8000 SERIES** YEARS 1990-2004

NOT AVAILABLE IN 10-GAUGE STEEL OR STAINLESS STEEL



EL-2010-24



EL-2010-24



EL-2000-24



EL-0000-24



EL-0010-24

## EM

**4000 SERIES, 7000 SERIES, 8000 SERIES** YEARS 1990-2004

NOT AVAILABLE IN 10-GAUGE STEEL OR STAINLESS STEEL



EM-2010-24



EM-2010-24



EM-2000-24

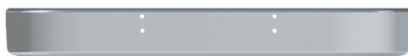

EM-0000-24



EM-0010-24

# INTERNATIONAL BUMPERS

EXAMPLE STYLES FOR PRODUCTS ON THIS PAGE:



Width	End Style Code
13"	15
16"	16
18"	17
*20"	34

\* No warranty for 20" wide bumpers

## 9400 SETBACK AXLE YEARS 1990-1996

CHECK 'ES' AND 'EP' SERIES PRIOR TO ORDERING

### EK

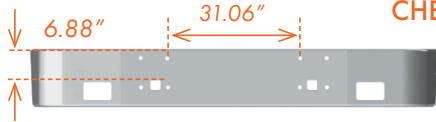

EK-2010-15



EK-2000-15



EK-0010-15



EK-0000-15

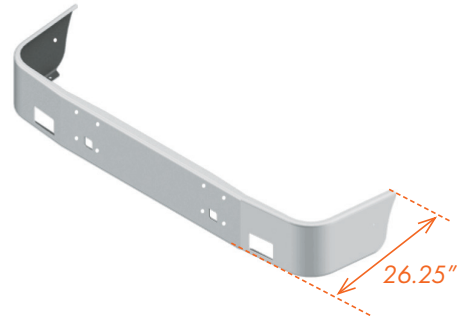

## 9200 SETBACK AXLE YEARS 1992-1996

CHECK 'EK' AND 'EP' SERIES PRIOR TO ORDERING

### ES

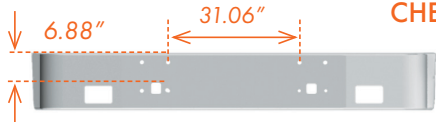

ES-2010-15

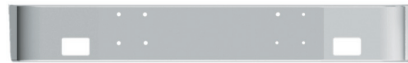

ES-2000-15



ES-0010-15



ES-0000-15

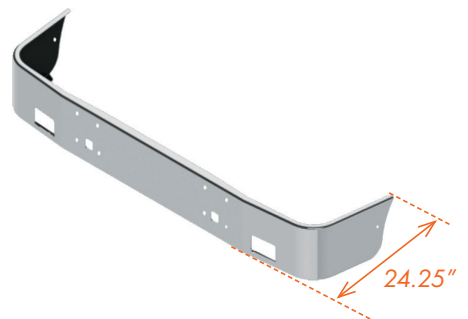

## 9100, 9200, 9400 SETBACK AXLE YEARS 1997-2007

CHECK 'EK' AND 'ES' SERIES PRIOR TO ORDERING

### EP

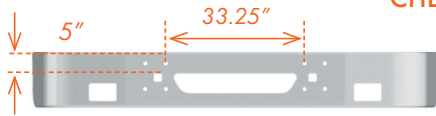

EP-2011-15



EP-2010-15



EP-0012-15 (radar)



EP-0011-15



EP-2000-15



EP-0010-15



EP-0001-15



EP-0011-15

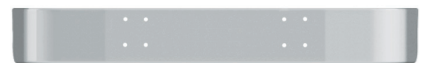

EP-0000-15

# INTERNATIONAL BUMPERS

AVAILABLE STYLES FOR PRODUCTS ON THIS PAGE:

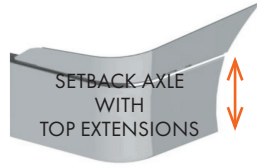

Width	End Style Code
16"	16X
18"	17X
*20"	34X

\* No warranty for 20" wide bumpers

## EU

### PROSTAR YEARS 2008-2017 FIXED MOUNT / NON-TILT MOUNTING BRACKETS AND EXTENSIONS INCLUDED



EU-5011-16X  
2 OEM fogs, tow pins, vent



EU-5010-16X-V9  
2 OEM fogs, tow pins, round radar  
Use option - V8 for rectangular radar



EU-0011-16X  
Tow pins, vent



EU-5010-16X  
2 OEM fogs, tow pins



EU-0010-16X  
Tow pins



EU-0000-16X  
No cutouts, mounting only



REAR VIEW

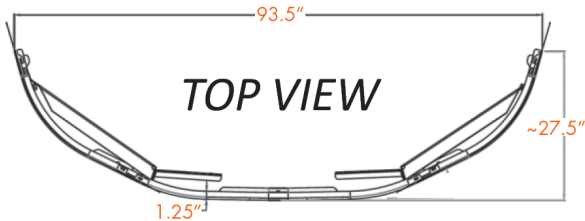

TOP VIEW



EU-5011-16X

# INTERNATIONAL BUMPERS

AVAILABLE STYLES FOR PRODUCTS ON THIS PAGE:

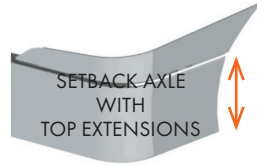

Width	End Style Code
16"	16X
18"	17X
*20"	34X

\* No warranty for 20" wide bumpers

## LT SERIES YEARS 2017 & NEWER

MOUNTING BRACKETS AND EXTENSIONS INCLUDED

REPLACES PLASTIC BUMPERS ONLY

# EY



EY-5013-16X

2 OEM fogs, tow pins, slotted vent



EY-0010-16X

Tow pins



EY-2011-16X

2 rectangular fogs, tow pins, open vent



EY-0013-16X

Tow pins, slotted vent



EY-0000-16X

Mounting Only



EY-0011-16X

Tow pins, open vent

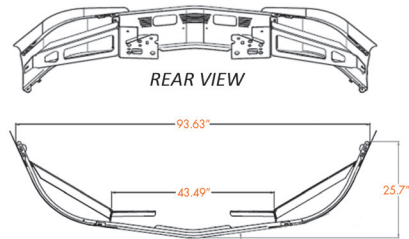

## MV607 SETBACK AXLE YEARS 2024 & NEWER

(-15) END STYLE FOR THIS SERIES IS 14"

# EZ



12 to 14"	15
16"	16
18"	17
20**	34

\* No warranty for 20" wide bumpers

Factory Fog Light Mounting Holes



EZ-0011-15

Tow, Vent

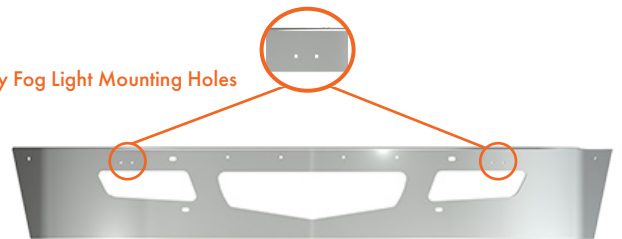

EZ-5011-15

Fog, Tow, Vent



SHOWN WITH FACTORY GRILL INSERT (GRILL INSERT NOT INCLUDED)

# INTERNATIONAL BUMPERS

AVAILABLE STYLES FOR PRODUCTS ON THIS PAGE:



FACTORY  
STYLE

**Width**  
14"

**End Style  
Code**  
38

10 GAUGE ONLY



SETBACK  
AXLE

**Width**  
13"  
16"  
18"  
\*20"

**End Style  
Code**

15
16
17
34

\* No warranty for  
20" wide bumpers

## ET 4000 SERIES MEDIUM DUTY / DURASTAR YEARS 2002 & NEWER

AUTOMATIC MUST INCLUDE VENT HOLE  
ADAPTER BRACKETS INCLUDED



ET-0011-15



ET-0021-15



ET-0021-15  
(alternate view) 24"

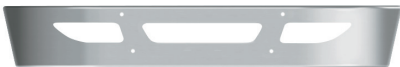

ET-0010-15

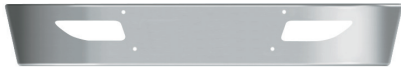

ET-0020-15



ET-0021-38  
(alternate view) 8"



ET-0001-15



ET-0021-15

## EV 7000 SERIES MEDIUM DUTY / WORKSTAR YEARS 2006 & NEWER

AUTOMATIC MUST INCLUDE VENT HOLE  
INCLUDES ONE SET LICENSE PLATE HOLES



EV-5001-38



EV-5000-38



EV-5001-15  
(alternate view) 16"



EV-0001-38



EV-0000-38

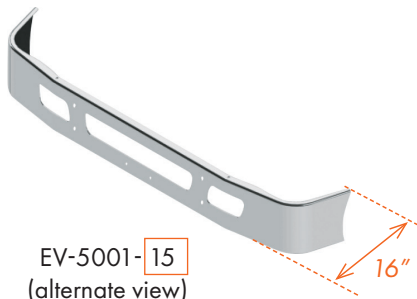



EV-5001-38  
(alternate view) 8"



EV-5001-38





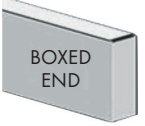
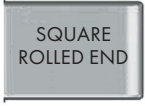



# KENWORTH BUMPERS

EXAMPLE STYLES FOR PRODUCTS ON THIS PAGE:

 <p>TAPER ROLLED END</p>	Width	End Style Code	 <p>GULLWING</p>	 <p>BOXED END</p>	 <p>SQUARE ROLLED END</p>		
	12"	01				Width	End Style Code
	16"	02				16"	07
	18"	03					
	20"	31					
22"	32						
	Width	End Style Code		Width	End Style Code		
	12"	09		12"	04		
	16"	10		16"	05		
	18"	11		18"	06		
	20"	51		20"	41		
	22"	52		22"	42		



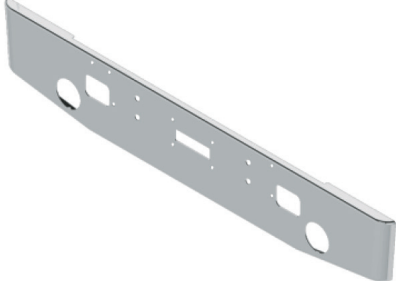

## K100C CABOVER YEARS 1967-1983

### FA

		
FA-1110-02	FA-1100-02	FA-1010-02
		
FA-0110-02	FA-1000-02	FA-0100-02
		
FA-0010-02	FA-0000-02	

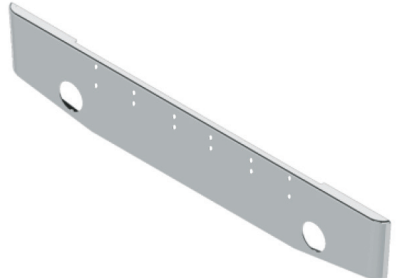

## LOGGER YEARS 1967-1981

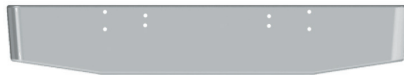
### FF

		
FF-1090-02	FF-1000-02	
		
FF-0090-02	FF-0000-02	



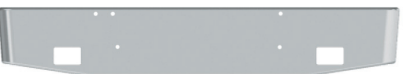
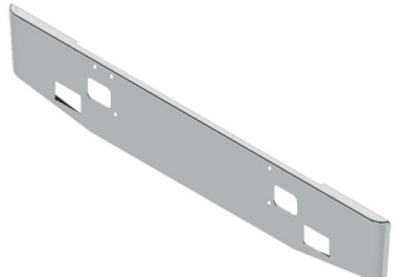
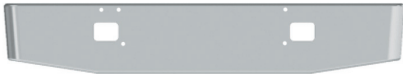

## K100E YEARS 1984-1999

### FB

		
FB-2010-02	FB-2000-02	
		
FB-0010-02	FB-0000-02	

# KENWORTH BUMPERS

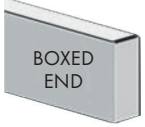
AVAILABLE STYLES FOR PRODUCTS ON THIS PAGE:

 <p>TAPER ROLLED END</p>	Width	End Style Code	 <p>GULLWING</p>	 <p>BOXED END</p>	Width	End Style Code	 <p>SQUARE ROLLED END</p>	Width	End Style Code				
	12"	01								12"	09	12"	04
	16"	02								16"	10	16"	05
	18"	03								18"	11	18"	06
	20"	31								20"	51	20"	41
	22"	32								22"	52	22"	42

## FD

### W900A YEARS 1967-1981



FD-1210-07



FD-1200-07



FD-1010-07



FD-0210-07



FD-1000-07



FD-0200-07



FD-0010-07

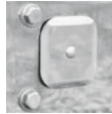

VK120003  
Tow Pin Covers (pair)  
Fits FD,FE,FT & more



FD-0000-07

## FE

### W900B YEARS 1982-2010 • W900L YEARS 1982 & NEWER



FE-2210-02



FE-2200-02

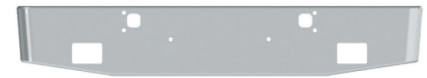

FE-2010-02



FE-0210-02

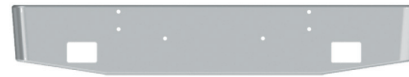

FE-2000-02



FE-0200-02

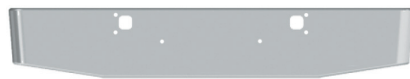

FE-0010-02



FE-0210-02

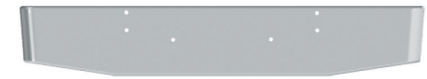

FE-0000-02

## FT

### W900B YEARS 2011 & NEWER, DOES NOT FIT W900L



FT-2210-06



FT-2200-06



FT-2010-06



FT-0210-06



FT-2000-06



FT-0200-06



FT-0010-06

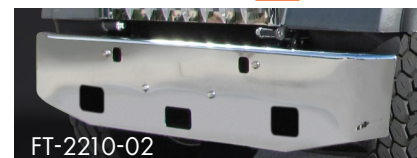

FT-2210-02







FT-0000-06

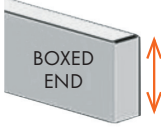

# KENWORTH BUMPERS

EXAMPLE STYLES FOR PRODUCTS ON THIS PAGE:

 <p>TAPER ROLLED END</p>	Width	End Style Code	 <p>GULLWING</p>	 <p>BOXED END</p>	Width	End Style Code	 <p>SQUARE ROLLED END</p>	Width	End Style Code				
	12"	01								12"	09	12"	04
	16"	02								16"	10	16"	05
	18"	03								18"	11	18"	06
	20"	31								20"	51	20"	41
22"	32	22"	52	22"	42								

## W900S YEARS 1989-2007

### FJ



FJ-2010-01



FJ-2000-01

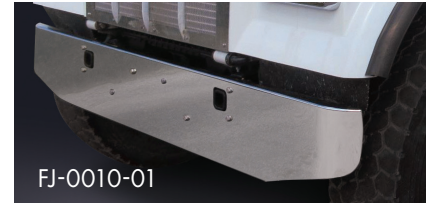

FJ-0010-01



FJ-0010-01



FJ-0000-01

## W900S YEARS 2008 & NEWER

### FQ



FQ-2210-02



FQ-2200-02



FQ-2010-02



FQ-0210-02



FQ-2000-02



FQ-0200-02



FQ-0010-02



FQ-0010-02

## W990 YEARS 2018 & NEWER

### FW



FW-2210-06



FW-2000-06



FW-0210-02



FW-2010-06



FW-0010-06



FW-0210-06

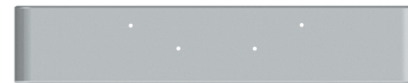

FW-0000-06

# KENWORTH BUMPERS

AVAILABLE STYLES FOR PRODUCTS ON THIS PAGE:



Width	End Style Code
14"	25
16"	13
18"	14

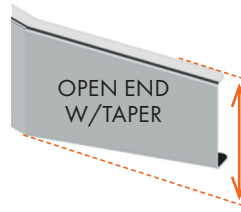

Width	End Style Code
14"	26
16"	132T
18"	142T

## FG

### T800 YEARS 1986-2003

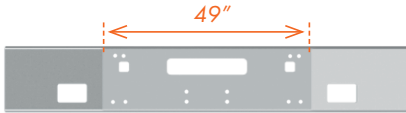

FG-2191-25

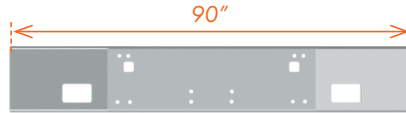

FG-2190-25



FG-2101-25



FG-2091-25



FG-0191-25



FG-2100-25



FG-2090-25



FG-2001-25



FG-0190-25



FG-0101-25



FG-0091-25



FG-2000-25



FG-0100-25



FG-0090-25



FG-0001-25



FG-0101-25



FG-0000-25



FG-0101-26

## FP

### T800W WIDENOSE - YEARS 1988-2005

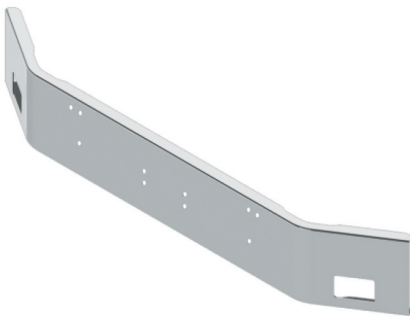

FP-2090-25



FP-0090-25



FP-2000-25



FP-0000-25

# KENWORTH BUMPERS

AVAILABLE STYLES FOR PRODUCTS ON THIS PAGE:

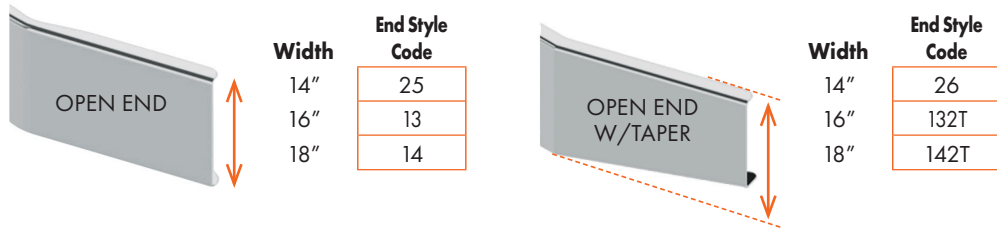

## T800, T880 YEARS 2004 & NEWER

# FN

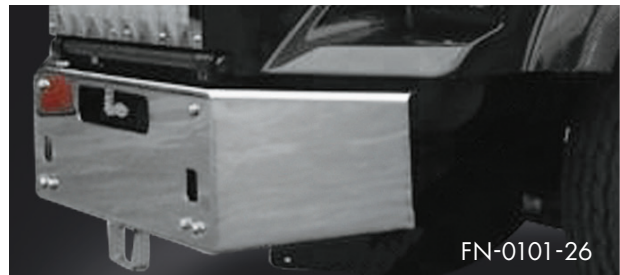
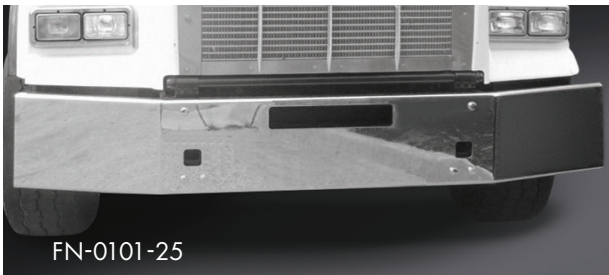
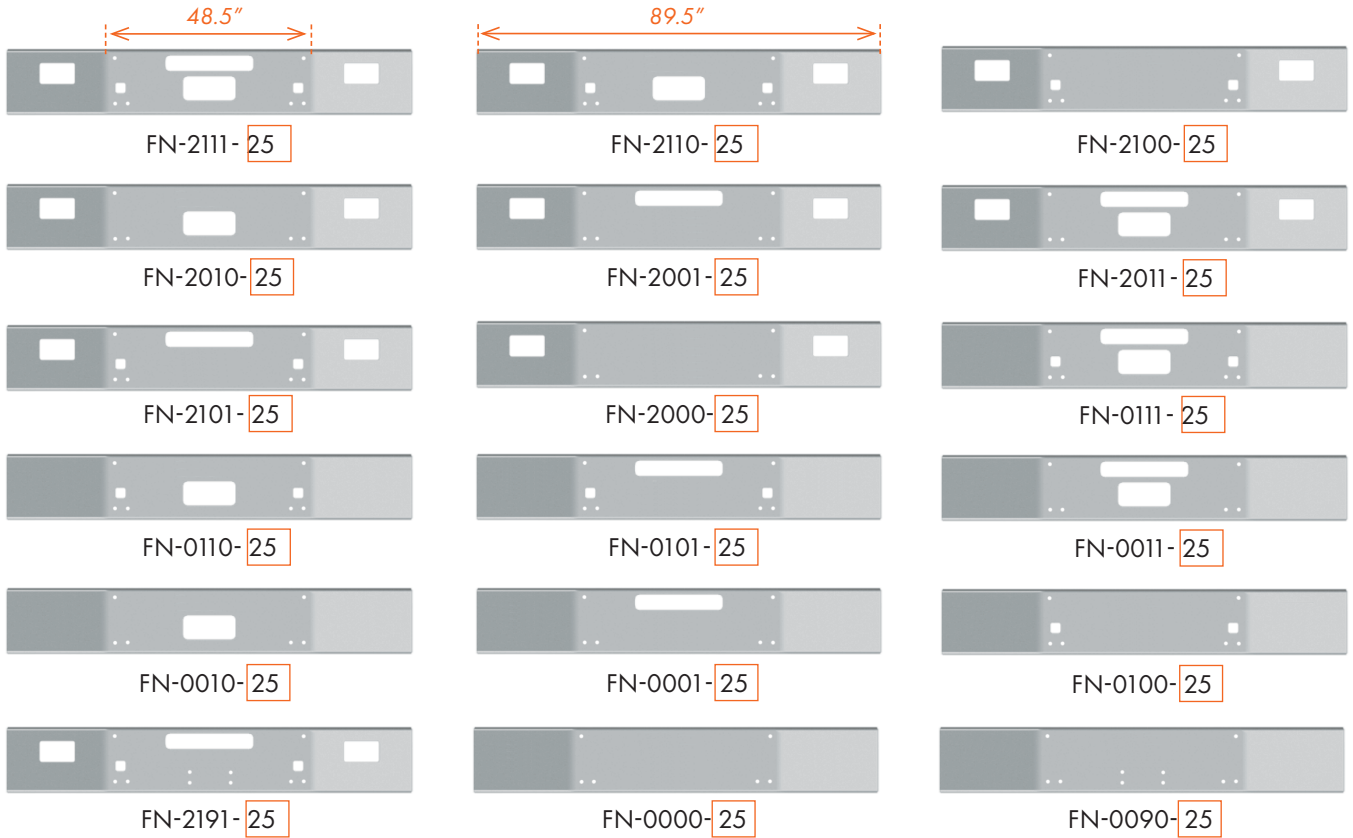

# KENWORTH BUMPERS

AVAILABLE STYLES FOR PRODUCTS ON THIS PAGE:

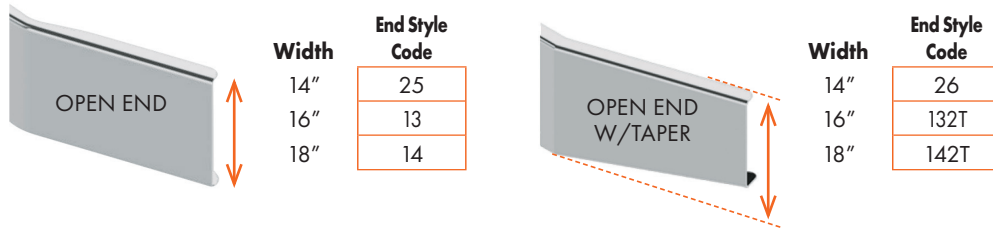

## FK

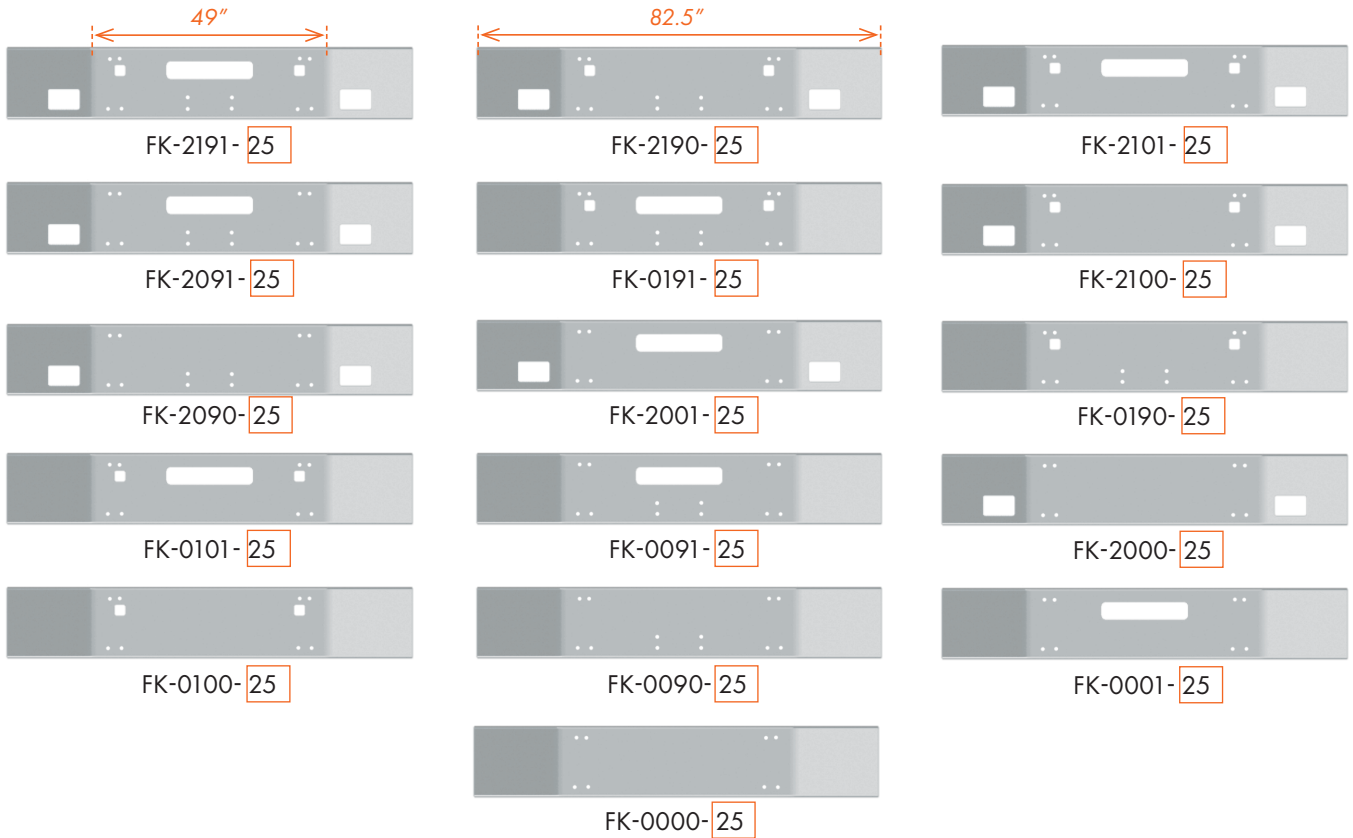

**T450B** YEARS 1994-1997

SIMILAR BOLT PATTERN AS 'FG' SERIES BUT SHORTER BUMPER LENGTH



# KENWORTH BUMPERS

AVAILABLE STYLES FOR PRODUCTS ON THIS PAGE:

<b>FL</b>  SET FORWARD AXLE	<b>Width</b> 13" 16" 18" *20"	<b>End Style Code</b> <table border="1"> <tr><td>18</td></tr> <tr><td>19</td></tr> <tr><td>20</td></tr> <tr><td>35</td></tr> </table>	18	19	20	35	<b>FS</b>  SETBACK AXLE	<b>Width</b> 16"	<b>End Style Code</b> <table border="1"> <tr><td>16</td></tr> </table>	16	<b>FU</b>  SET BACK GULLWING	<b>Width</b> 15" 18" *20"	<b>End Style Code</b> <table border="1"> <tr><td>708</td></tr> <tr><td>709</td></tr> <tr><td>711</td></tr> </table>	708	709	711
18																
19																
20																
35																
16																
708																
709																
711																

\* No warranty for 20" wide bumpers

## T300 SET FORWARD AXLE YEARS 1997-2008

MOUNTS TO FACTORY BRACKETS

**FL**

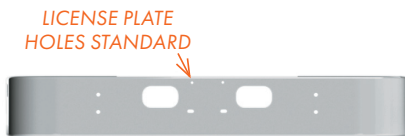

FL-0010-18

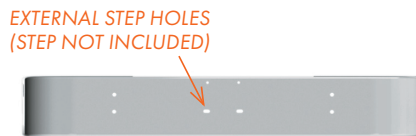

FL-0000-18

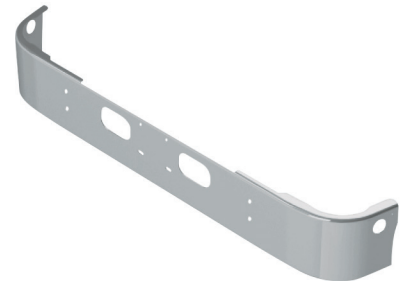

## T270, T370 SET BACK AXLE YEARS 2008 & NEWER

ADAPTER BRACKETS INCLUDED. 16" WIDTH ONLY.

**FS**

NOW BOLTLESS

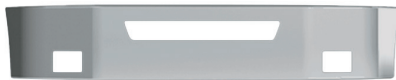

FS-2010-16

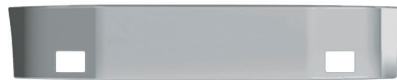

FS-2000-16

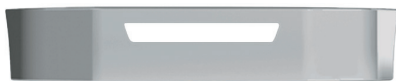

FS-0010-16

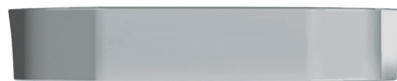

FS-0000-16

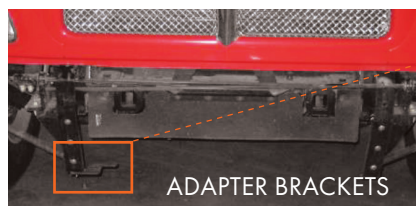

NEW BOLTLESS MOUNTING BRACKETS

## T440 SET BACK AXLE YEARS 2011 & NEWER

NOT AVAILABLE IN STAINLESS STEEL

**FU**



FU-0011-708



FU-0010-708



FU-0001-708



FU-0000-708

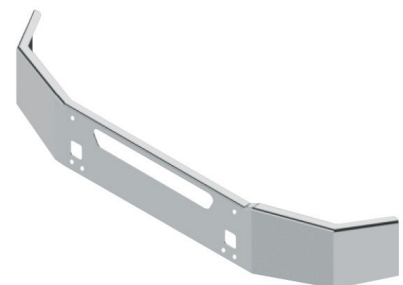

# KENWORTH BUMPERS

AVAILABLE STYLES FOR PRODUCTS ON THIS PAGE:



Width	End Style Code
13"	15
16"	16
18"	17
*20"	34

\* No warranty for 20" wide bumpers

## FH

**T600 YEARS 1987-2007**

SPACERS INCLUDED. MUST INCLUDE VENT HOLES FOR WARRANTY.



## FR

**T660 YEARS 2008-2017**  
MOUNTING BRACKETS INCLUDED

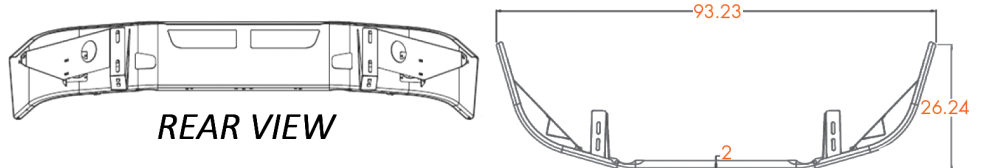
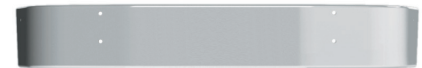
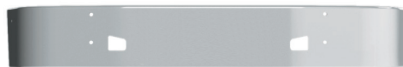
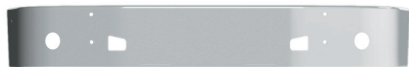

## FM

**T400 SET BACK AXLE YEARS 1989-2000**



# KENWORTH BUMPERS

AVAILABLE STYLES FOR PRODUCTS ON THIS PAGE:

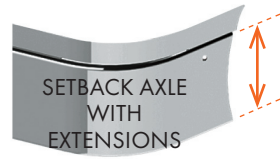

Width	End Style Code
14"	708
16"	709
18"	711
*20"	712

\* No warranty for 20" wide bumpers

## T680 SET BACK AXLE YEARS 2013 & NEWER

MOUNTING BRACKETS INCLUDED

### FV



FV-5210-708  
2 OEM fogs, step, tow pins



FV-0010-708-V4  
Tow pins, radar accommodation



FV-0210-708  
Step, tow pins

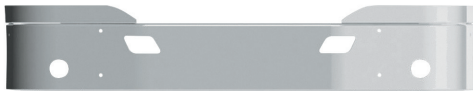

FV-5010-708  
2 OEM fogs, tow pins



FV-0010-708  
Tow pins



FV-0000-708  
Mounting only



FV-0010-708

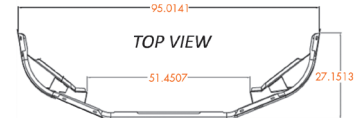

TOP VIEW

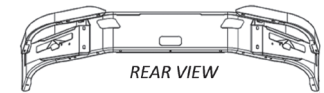

REAR VIEW

## T680 GEN II SET BACK AXLE YEARS 2021 & NEWER

MOUNTING BRACKETS INCLUDED

### FX



FX-0000-708  
Mounting only



FX-0010-708  
Tow pins



FX-0010-708-V4  
Tow pins, radar accommodation



FX-5210-708  
2 OEM fogs, step, tow pins



FX-5010-708  
2 OEM fogs, tow pins



FX-0210-708  
Step, tow pins



FX-0011-708-V4



FX-0011-708  
Vent, tow pins



FX-5011-708  
Vent, 2 OEM fogs, tow pins

# KENWORTH BUMPERS

AVAILABLE STYLES FOR PRODUCTS ON THIS PAGE:



<b>12"</b>	<b>18</b>
16"	19
18"	20
20"	35

\* No warranty for 20" wide bumpers

## T280, T380 & T480 SET FORWARD AXLE YEARS 2021 & NEWER **FY** MOUNTS TO FACTORY BRACKETS



FY-5000-18  
Fog



FY-5001-18  
Fog, Vent



FY-0000-18  
Mount Only



FY-0001-18  
Vent





# MACK BUMPERS

EXAMPLE STYLES FOR PRODUCTS ON THIS PAGE:

End Style	Width	End Style Code	End Style	Width	End Style Code	End Style	Width	End Style Code
TAPER ROLLED END	12"	01	BOXED END	12"	09	SQUARE ROLLED END	12"	04
	16"	02		16"	10		16"	05
	18"	03		18"	11		18"	06
	20"	31		20"	51		20"	41
	22"	32		22"	52		22"	42

## GA

## R, RL, F, FL, FS

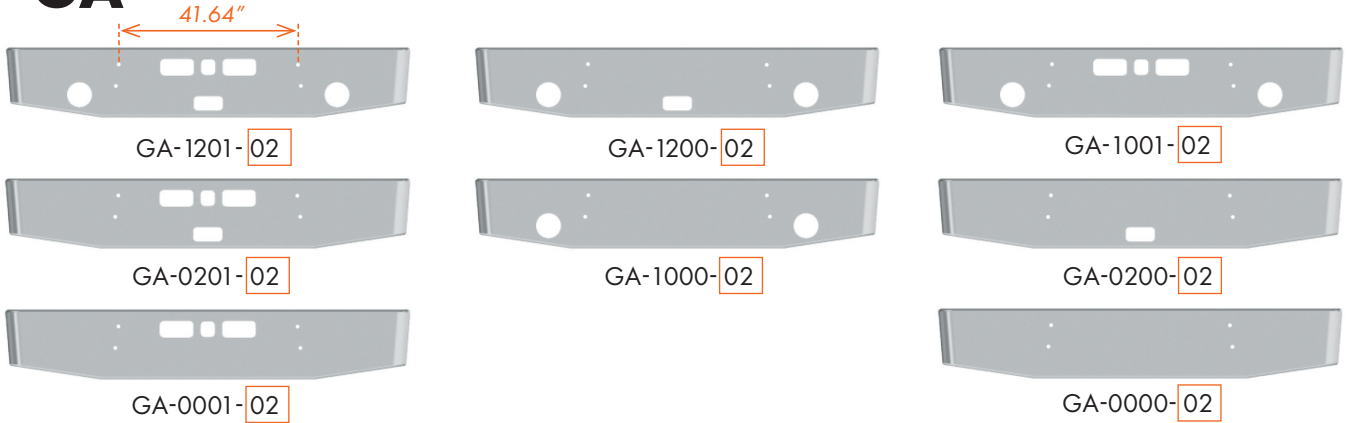

## GB

## SUPERLINER, CRUISELINER

NOT AVAILABLE IN 12" WIDTH

SUPERLINER NOT AVAILABLE IN GULLWING STYLE-07

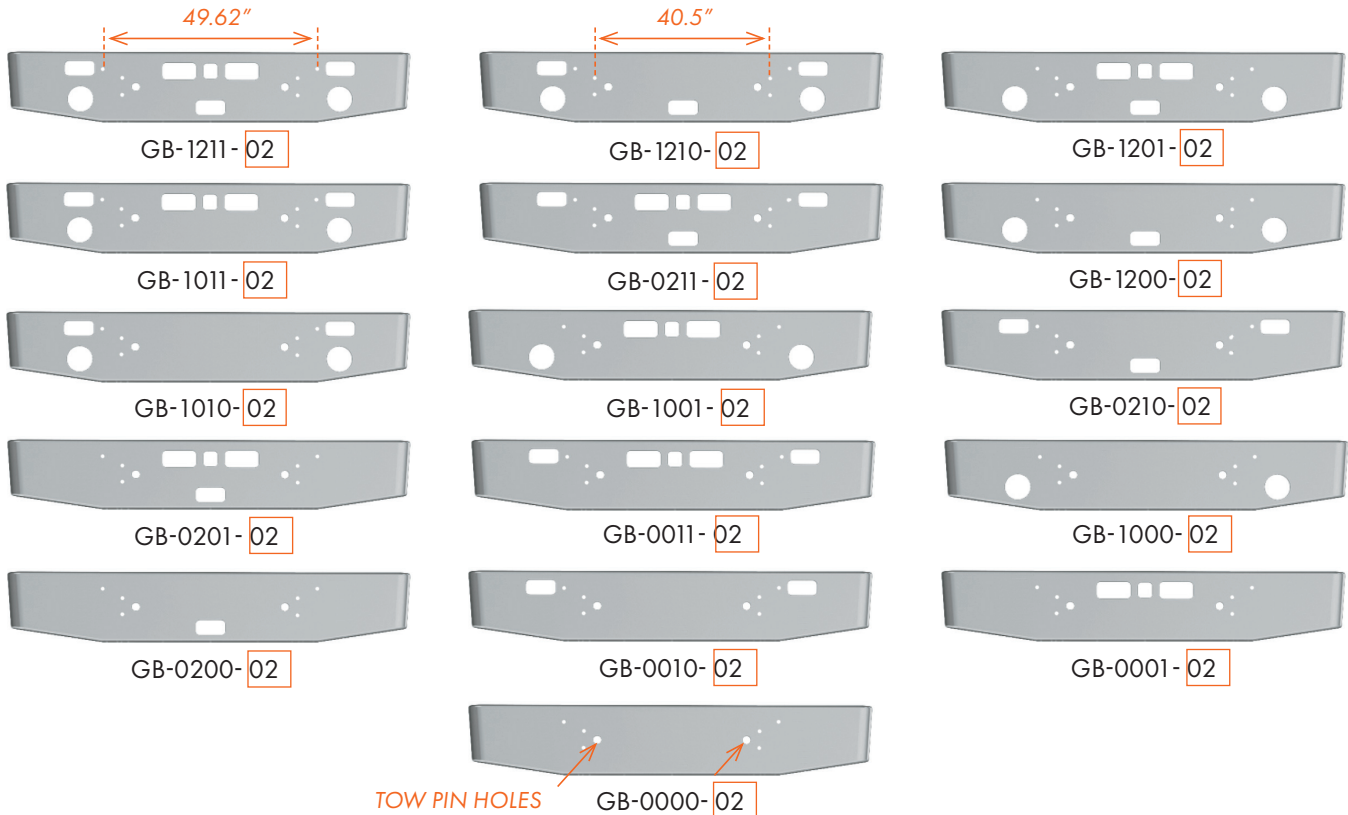

# MACK BUMPERS

EXAMPLE STYLES FOR PRODUCTS ON THIS PAGE:

Width	End Style Code	Width	End Style Code	Width	End Style Code
12"	01	12"	09	12"	04
16"	02	16"	10	16"	05
18"	03	18"	11	18"	06
20"	31	20"	51	20"	41
22"	32	22"	52	22"	42

## R-600, R-700

ADD- GG TO END OF ANY 'GC' PART NUMBER FOR GRILLE GUARD HOLES

**GC**

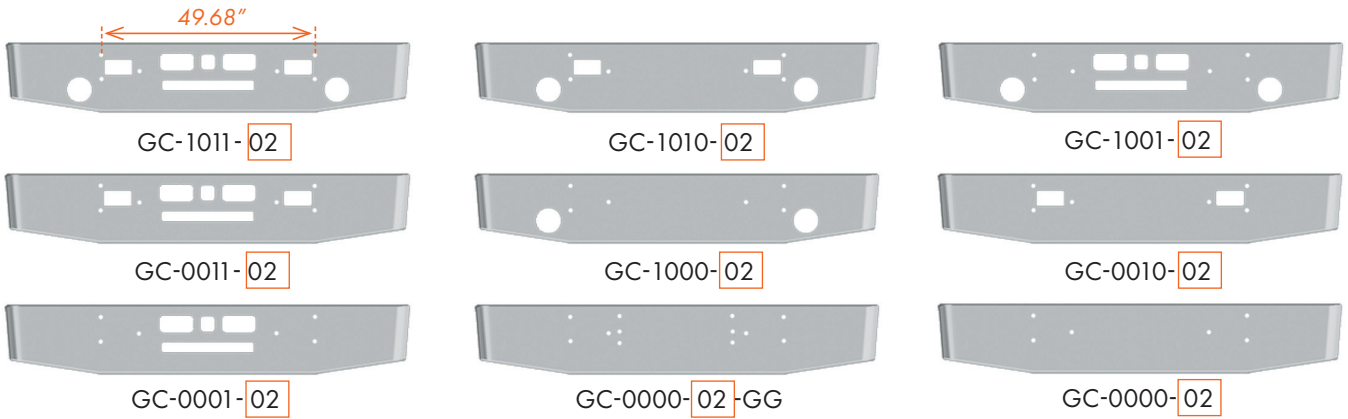

## GRILLE GUARDS

FIT OEM BUMPERS AND OUR BUMPERS GC, GH, GS, GV  
DOES NOT FIT OUR 'GZ' BUMPERS (SEE PAGE 54)  
STAINLESS STEEL ONLY

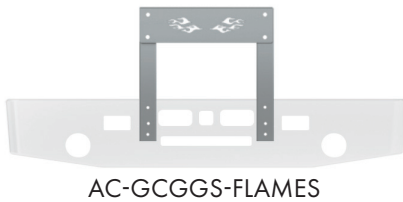

## F-600

**GD**

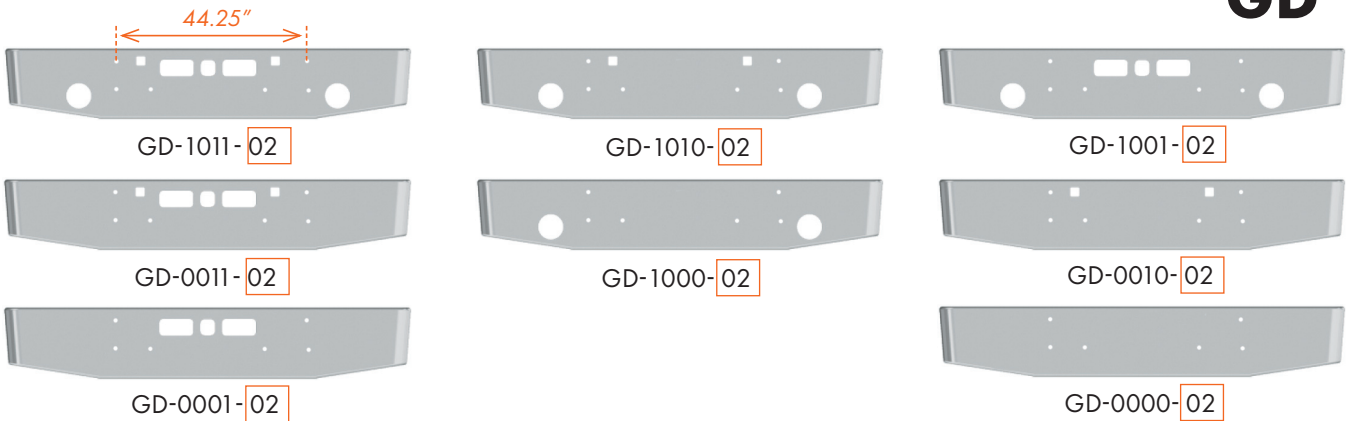

# MACK BUMPERS

EXAMPLE STYLES FOR PRODUCTS ON THIS PAGE:

Width	End Style Code	Width	End Style Code	Width	End Style Code
12"	01	12"	09	12"	04
16"	02	16"	10	16"	05
18"	03	18"	11	18"	06
20"	31	20"	51	20"	41
22"	32	22"	52	22"	42

## GE

### VALUELINER, WESTCOAST

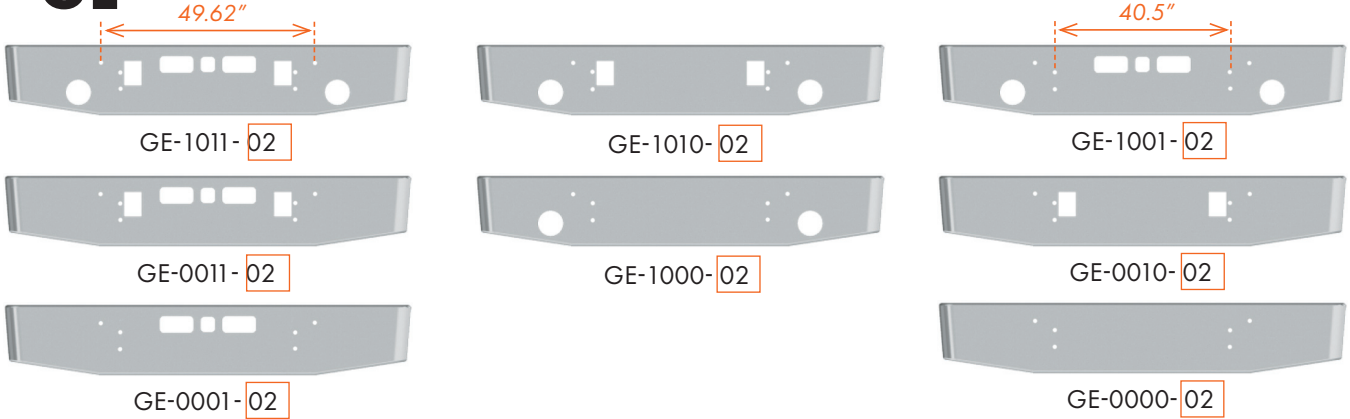

## GF

### F-700, INTERSTATE

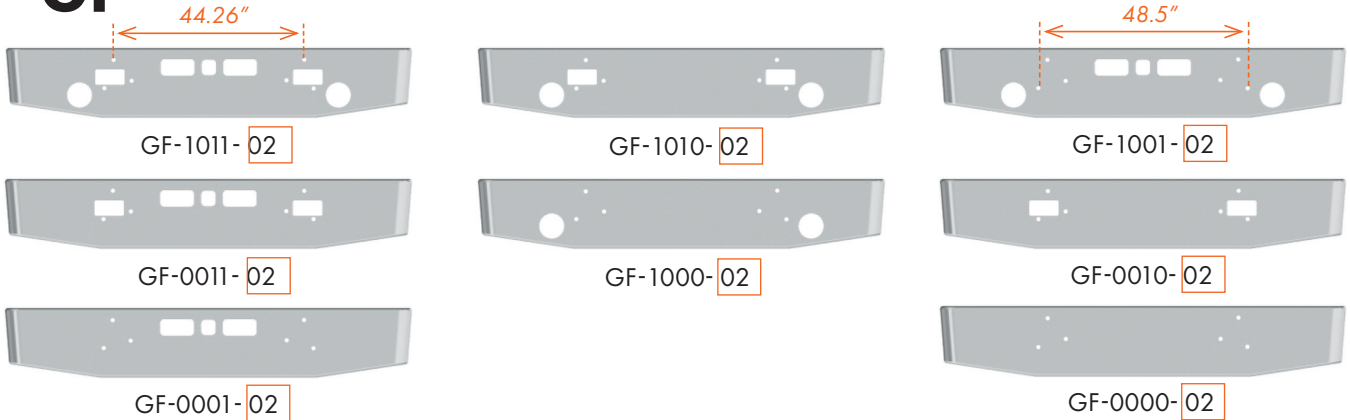

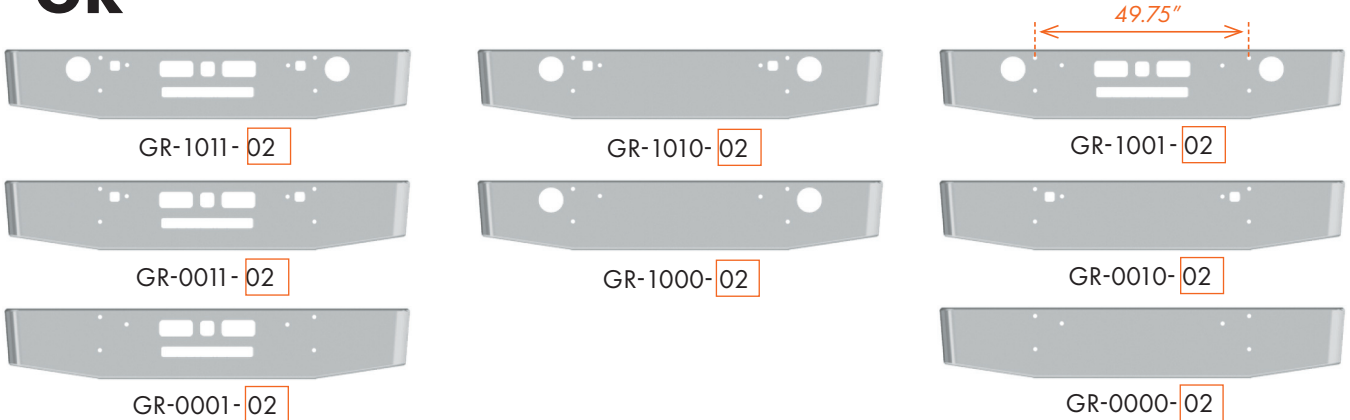

## GR

### R600 YEARS 1965 TO 1976

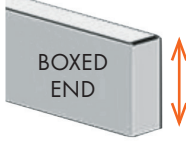

# MACK BUMPERS

EXAMPLE STYLES FOR PRODUCTS ON THIS PAGE:

Width	End Style Code	Width	End Style Code	Width	End Style Code
 TAPER ROLLED END	12"	01	 BOXED END	12"	09
	16"	02		16"	10
	18"	03		18"	11
	20"	31		20"	51
	22"	32		22"	52
			 SQUARE ROLLED END		
12"		12"		12"	04
16"		16"		16"	05
18"		18"		18"	06
20"		20"		20"	41
22"		22"		22"	42

## MH COE, SUPERLINER II, RW613

NOT AVAILABLE IN 12" WIDTH

**GG**

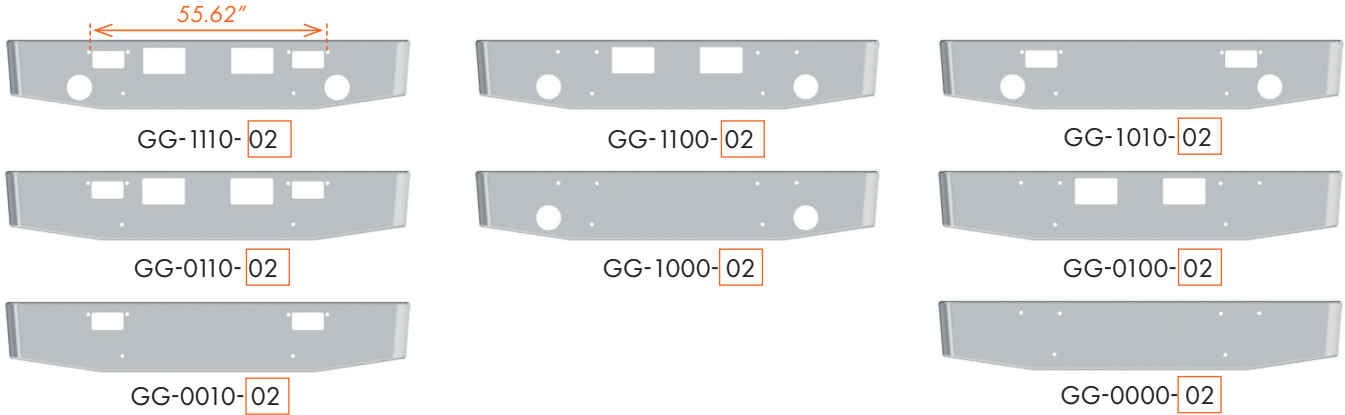

## WESTERN CONTRACTOR, RD688, RD690 YEARS 1989-2001

ADD-GG TO END OF ANY 'GH' PART NUMBER FOR GRILLE GUARD HOLES

**GH**

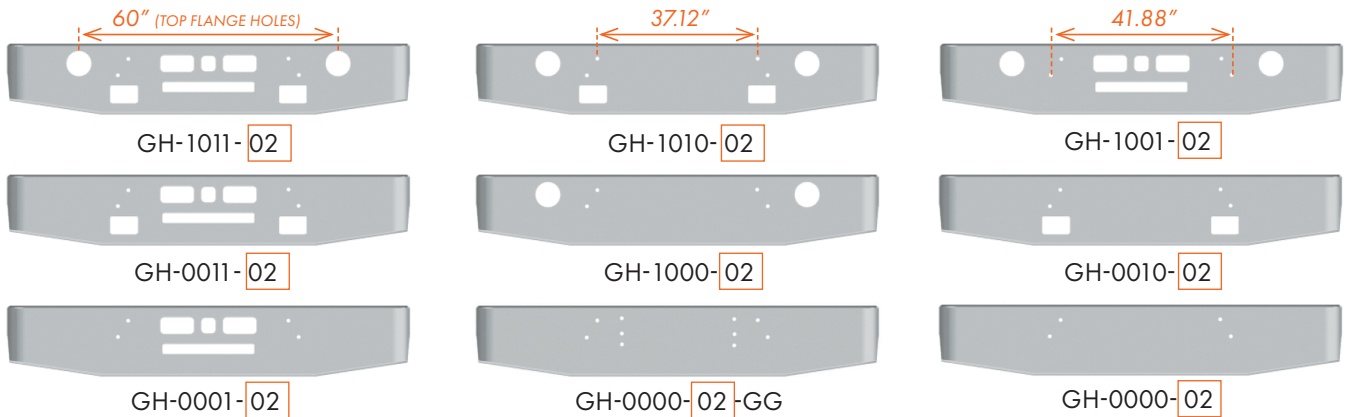

## GRILLE GUARDS

FIT OEM BUMPERS AND OUR BUMPERS GC, GH, GS, GQ, GV

DOES NOT FIT OUR 'GZ' BUMPERS (SEE PAGE 54)

STAINLESS STEEL ONLY



AC-GCGGS-FLAMES

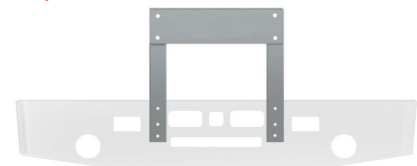

AC-GCGGS

# MACK BUMPERS

AVAILABLE STYLES FOR PRODUCTS ON THIS PAGE:



Width	End Style Code
10"	27
12"	12
14"	25
16"	13
18"	14

## GI

### LOGGER

NOT AVAILABLE IN 10" WIDTH (-27). NOTE LETTERS 'GI' IN PART NUMBER

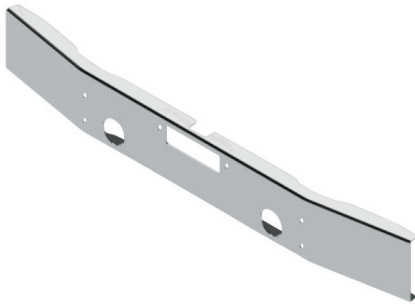

GI-1010-12

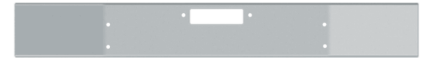

GI-0010-12

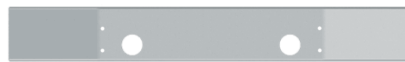

GI-1000-12

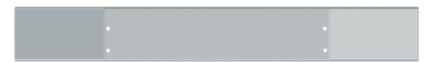

GI-0000-12

## GS

### RD SET BACK AXLE YEARS 1979-1988

GRILLE GUARD HOLES ARE STANDARD

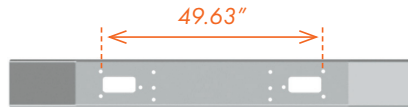
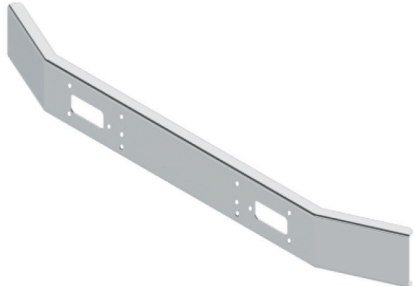

GS-0010-12

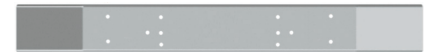

GS-0000-12

SEE PAGE 53 FOR GRILLE GUARDS

## GP

### MR, MRU, MD SERIES YEARS 2018 & OLDER

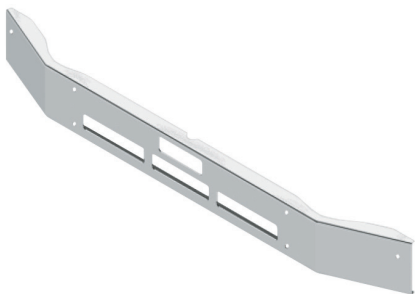

GP-0011-27



GP-0010-27



GP-0001-27

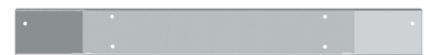

GP-0000-27

# MACK BUMPERS

AVAILABLE STYLES FOR PRODUCTS ON THIS PAGE:



Width

Width	End Style Code
10"	27
12"	12
14"	25
16"	13
18"	14

OPEN END

## CL SERIES YEARS 1994-2003

### GN

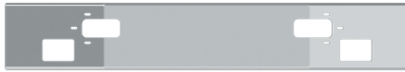

GN-2010-25



GN-2020-25

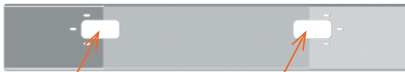

GN-0010-25  
OUTBOARD TOW PIN HOLES



GN-0020-25  
CENTER TOW PIN HOLE

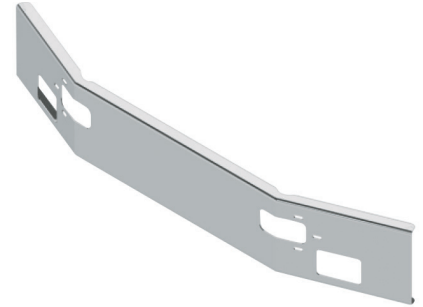

## RD688, RD690 YEARS 1993-2003

GRILLE GUARD HOLES ARE STANDARD

### GQ

SEE BELOW FOR GRILLE GUARDS



GQ-0000-27

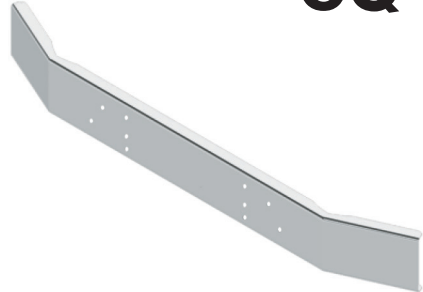

## CV SERIES, RD688DM YEARS 2003-2007

GRILLE GUARD HOLES ARE STANDARD

SEE BELOW FOR GRILLE GUARDS

### GV

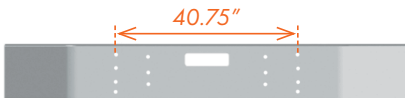

GV-0010-12



GV-0000-12

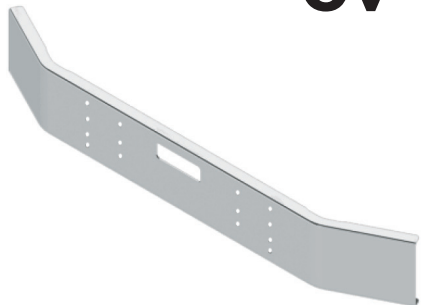

## GRILLE GUARDS

FIT OEM BUMPERS AND OUR BUMPERS GC, GH, GS, GQ, GV

DOES NOT FIT OUR 'GZ' BUMPERS (SEE PAGE 54)

STAINLESS STEEL ONLY



AC-GCGGS-FLAMES



AC-GCGGS

# MACK BUMPERS

AVAILABLE STYLES FOR PRODUCTS ON THIS PAGE:

GZ			GT			GT		
	Width	End Style Code		Width	End Style Code		Width	End Style Code
	10"	27		12"	01		12"	04
	12"	12		16"	02		16"	05
	14"	25		18"	03		18"	06
	16"	13		20"	31		20"	41
	18"	14		22"	32		22"	42

## GZ

### GRANITE, CTP713, GU713 YEARS 2007 & NEWER



GZ-2010-12

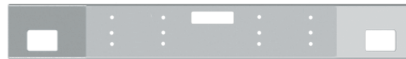

GZ-2020-12



GZ-0011-12

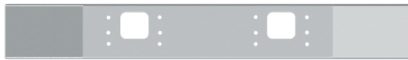

GZ-0010-12



GZ-0020-12

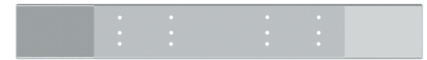

GZ-0000-12



GZ-0010-12



## GRILLE GUARDS

FITS GZ BUMPERS AND  
OEM EQUIVALENTS ONLY  
STAINLESS STEEL ONLY  
FOR OTHER MACK GRILLE  
GUARDS SEE PAGE 53

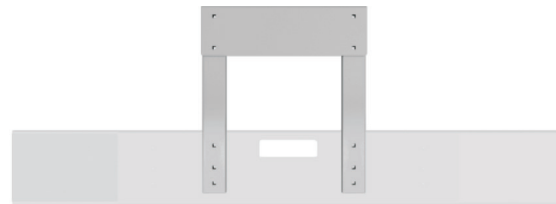

AC-GZGGS

## GT

### GRANITE, BRIDGE FORMULA YEARS 2003-2007



GT-2210-02



GT-2200-02

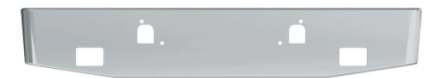

GT-2010-02

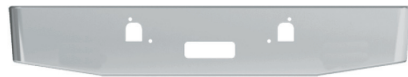

GT-0210-02

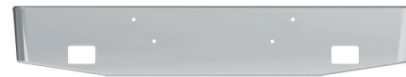

GT-2000-02



GT-0200-02

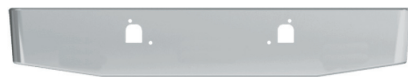

GT-0010-02

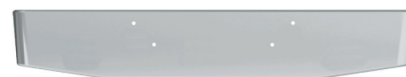

GT-0000-02

# MACK BUMPERS

AVAILABLE STYLES FOR PRODUCTS ON THIS PAGE:

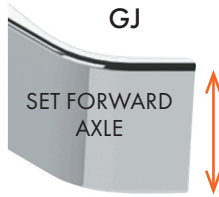

GJ

Width

- 13"
- 16"
- 18"
- 20"

End Style Code

18
19
20
35



GX

Width

- 17.5"

End Style Code

19
----

## CH SERIES SET FORWARD AXLE YEARS 1994-2004

BRACKETS INCLUDED & BOLTED IN

**GJ**



GJ-2210-18



GJ-2200-18



GJ-2010-18



GJ-0210-18



GJ-2000-18



GJ-0200-18

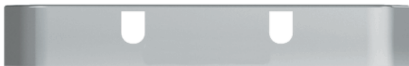

GJ-0010-18

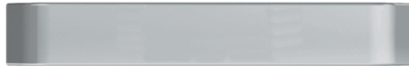

GJ-0000-18



## CH SERIES SET FORWARD AXLE YEARS 2005 & NEWER

ALSO FITS RAWHIDE

**GX**

MOUNTS TO FACTORY BRACKETS, BRACKETS NOT INCLUDED. LICENSE PLATE HOLES INCLUDED.



GX-1211-19



GX-1210-19



GX-0210-19



GX-0211-19

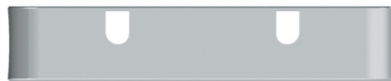

GX-0010-19

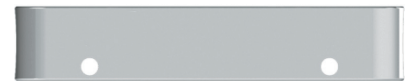

GX-1000-19



GX-0200-19



GX-0000-19

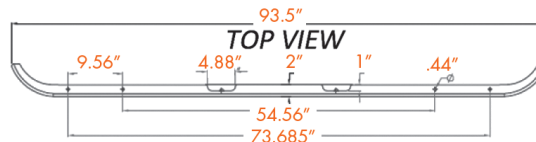
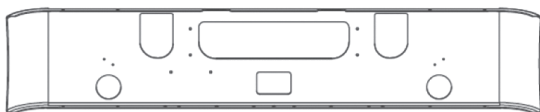
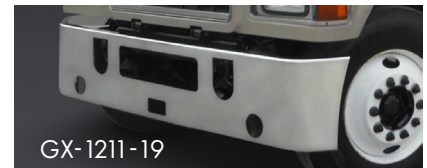



# MACK BUMPERS

AVAILABLE STYLES FOR PRODUCTS ON THIS PAGE:



Diagram showing a bumper setback axle with the text "SETBACK AXLE" and a double-headed arrow indicating the setback distance.

Width	End Style Code
14"	15
16"	16
18"	17
*20"	34

\* No warranty for 20" wide bumpers

## GM

### CH SERIES SET BACK AXLE YEARS 1988-1993 BRACKETS INCLUDED & BOLTED IN

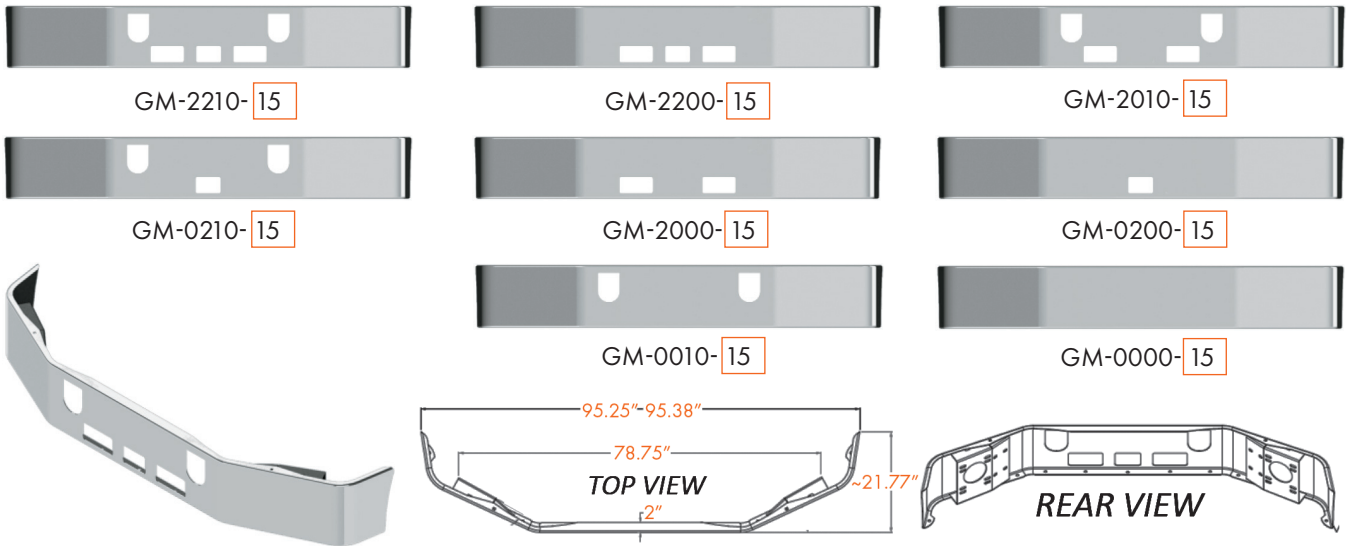

GM bumper styles shown:

- GM-2210-15
- GM-2200-15
- GM-2010-15
- GM-0210-15
- GM-2000-15
- GM-0200-15
- GM-0010-15
- GM-0000-15

Technical drawings include a 3D perspective view, a TOP VIEW with dimensions: 95.25"-95.38" (width), 78.75" (length), and 2" (height); and a REAR VIEW with a height dimension of ~21.77".

## GL

### CH SERIES SET BACK AXLE YEARS 1994-2004 BRACKETS INCLUDED & BOLTED IN

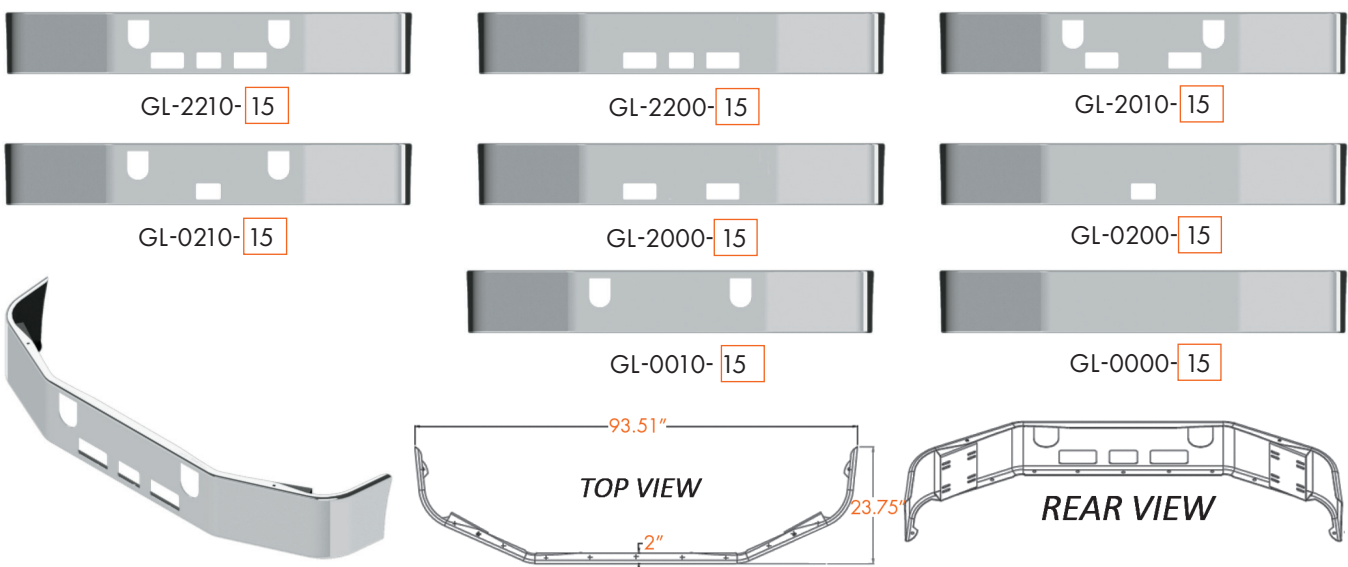

GL bumper styles shown:

- GL-2210-15
- GL-2200-15
- GL-2010-15
- GL-0210-15
- GL-2000-15
- GL-0200-15
- GL-0010-15
- GL-0000-15

Technical drawings include a 3D perspective view, a TOP VIEW with dimensions: 93.51" (width), 23.75" (length), and 2" (height); and a REAR VIEW.

# MACK BUMPERS

AVAILABLE STYLES FOR PRODUCTS ON THIS PAGE:

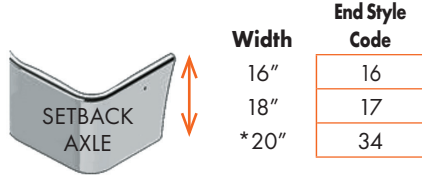

\* No warranty for 20" wide bumpers

## CX SERIES, VISION SET BACK AXLE YEARS 2001-2004

MOUNTING BRACKETS INCLUDED

**GU**



GU-2210-16



GU-2200-16



GU-2010-16



GU-0210-16



GU-2000-16



GU-0200-16

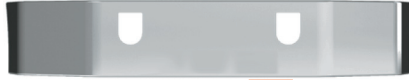

GU-0010-16

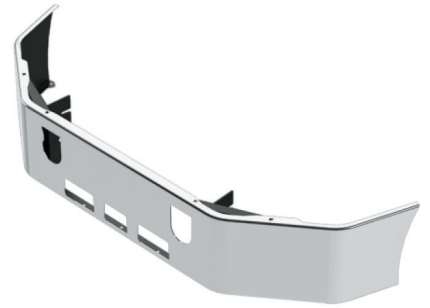
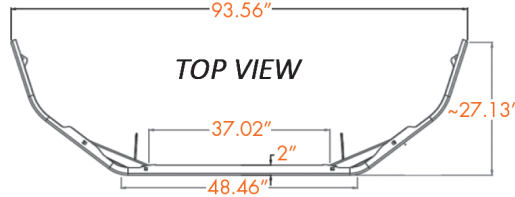
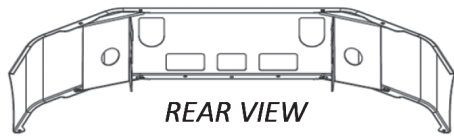

## CXP, CXN SERIES SET BACK AXLE YEARS 2005 & NEWER

MOUNTING BRACKETS INCLUDED  
ONE SET UPPER LICENSE PLATE HOLES INCLUDED

**GW**



GW-1210-16



GW-1200-16



GW-1010-16



GW-0210-16



GW-1000-16



GW-0010-16

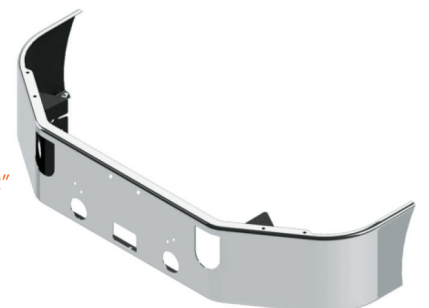
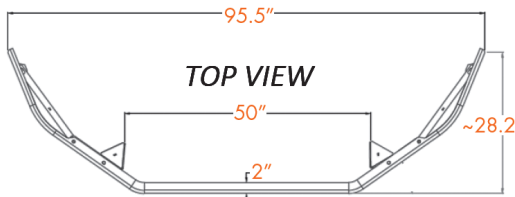
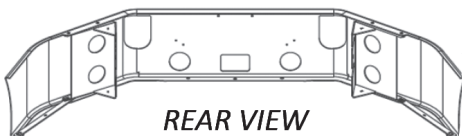

# MACK BUMPERS

AVAILABLE STYLES FOR PRODUCTS ON THIS PAGE:



Width	End Style Code
16"	16
18"	17
*20"	34

\* No warranty for 20" wide bumpers

## GY

**CXU SERIES SET BACK AXLE** YEARS 2008 & NEWER  
BRACKETS NOT INCLUDED. REPLACES STAINLESS CLAD BUMPERS.  
BRACKETS REQUIRED FOR URETHANE REPLACEMENT – SEE BELOW

**ANTHEM** SET BACK AXLE YEARS 2017 & NEWER  
BRACKETS NOT INCLUDED – REPLACES STAINLESS CLAD BUMPERS ONLY



GY-1211-16  
Round fogs, step, tow, vent holes



GY-1200-16  
Round fogs, step holes



GY-0211-16  
Step, tow, vent holes



GY-0210-16  
Step, tow holes



GY-0010-16  
Tow holes



GY-0200-16  
Step hole

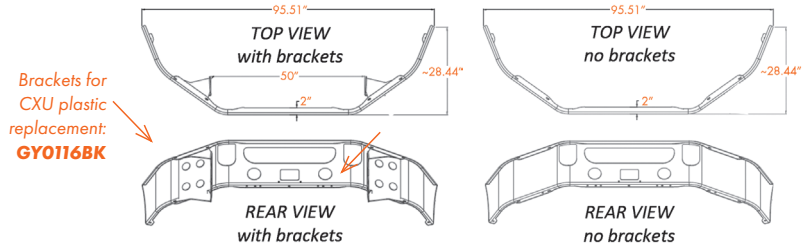

## GOB

**ANTHEM** SET BACK AXLE YEARS 2018 & NEWER  
BRACKETS INCLUDED – REPLACES URETHANE BUMPERS ONLY



GOB-0000-16  
Mount Only



GOB-0001-16  
Vent Hole



GOB-0010-16  
Tow Holes



GOB-0011-16  
Tow Holes, Vent Hole



GOB-0211-16  
Center Step, Tow Holes, Vent Hole



GOB-2001-16  
2 Square Fogs, Vent Hole



# PETERBILT BUMPERS

EXAMPLE STYLES FOR PRODUCTS ON THIS PAGE:

Width	End Style Code	Width	End Style Code	Width	End Style Code
12"	01	12"	09	12"	04
16"	02	16"	10	16"	05
18"	03	18"	11	18"	06
20"	31	20"	51	20"	41
22"	32	22"	52	22"	42

## 352 CABOVER YEARS 1967-1980

### HA

## 359 CONVENTIONAL YEARS 1967-1986



HA-1010-02



HA-1000-02



HA-0010-02



HA-2010-02

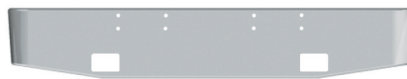

HA-2000-02

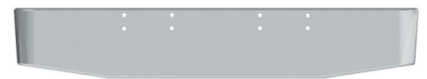

HA-0000-02

## LOGGER YEARS 1973-1986

### HE



HE-1090-02



HE-1000-02



HE-0090-02

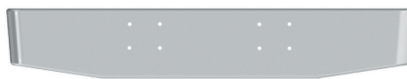

HE-0000-02

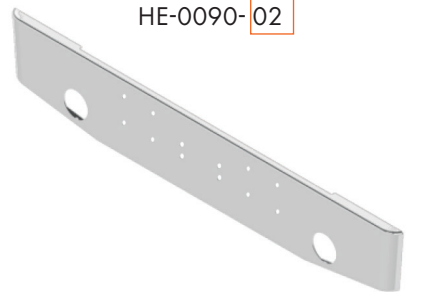

## 362 CABOVER YEARS 1981 & NEWER

NOT AVAILABLE IN 12" WIDTH (-01,-04,-09,-91)

### HK



HK-1110-02



HK-1100-02



HK-1010-02



HK-0110-02



HK-1000-02



HK-0100-02



HK-0010-02



HK-0000-02

# PETERBILT BUMPERS

EXAMPLE STYLES FOR PRODUCTS ON THIS PAGE:

Width	End Style Code	Width	End Style Code	Width	End Style Code
12"	01	12"	09	12"	04
16"	02	16"	10	16"	05
18"	03	18"	11	18"	06
20"	31	20"	51	20"	41
22"	32	22"	52	22"	42

## HD

### 375 CONVENTIONAL YEARS 1987-1994



HD-2011-02



HD-2010-02



HD-2001-02

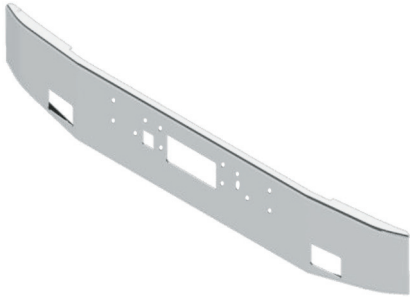

HD-0011-02



HD-0010-02



HD-0001-02



HD-0000-02

## HC

### 379, 378, 357 YEARS 1987-2007



HC-2010-02



HC-2000-02



HC-0010-02



HC-0020-02



HC-0000-02



HC-0010-06

SEE PAGE 61 FOR SUPPORT BRACKETS

## HF

### LOGGER YEARS 1987-2007



HF-2090-02



HF-0090-02



HF-3090-01



HF-0090-01

# PETERBILT BUMPERS

## BUMPER SUPPORT BRACKETS – MODEL 379

### VP15-06333L-22

for 20" to 22" bumpers



### VP15-06333L-20

for 16" to 20" bumpers

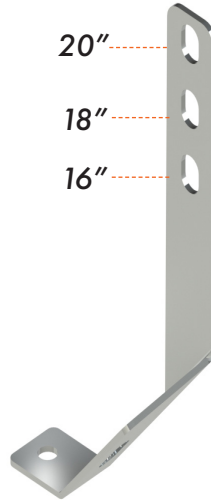

MARKED FOR DRIVER & PASSENGER SIDES



ADD THESE BRACKETS FOR A MORE RIGID INSTALLATION.  
POWDER-COATED STEEL.  
FASTENERS NOT INCLUDED.  
SOLD AS A PAIR.

## BUMPER SUPPORT BRACKETS – MODEL 389 & 589

### VCN11-6061-22

for 20" to 22" bumpers

22"  
20"

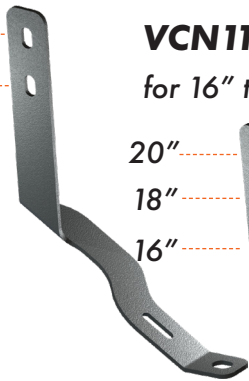

### VCN11-6061-20

for 16" to 20" bumpers

20"  
18"  
16"



### OEM bracket N11-6061

For 16" bumpers  
(shown for comparison)



SAME BRACKET USED FOR DRIVER & PASSENGER SIDES

# PETERBILT BUMPERS

EXAMPLE STYLES FOR PRODUCTS ON THIS PAGE:

Width	End Style Code	Width	End Style Code	Width	End Style Code
12"	01	12"	09	12"	04
16"	02	16"	10	16"	05
18"	03	18"	11	18"	06
20"	31	20"	51	20"	41
22"	32	22"	52	22"	42

## HV

**365, 367, 388, 389, 567, YEARS 2007 & NEWER**  
**589, YEARS 2024 & NEWER**



HV-2210-02



HV-2200-02

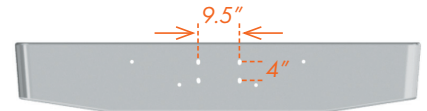

HV-0090-02



HV-0010-06

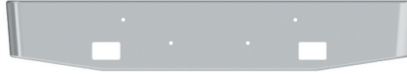

HV-2000-02



HV-0210-02

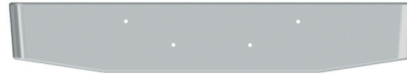

HV-0000-02

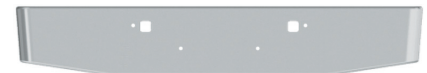

HV-0010-02

SEE PAGE 61 FOR SUPPORT BRACKETS

## HOB

**388 HIGH CLEARANCE YEARS 2007 & NEWER**  
 NOTE LETTERS 'HOB' IN PART NUMBER



HOB-2090-01



HOB-2000-01



HOB-0090-01

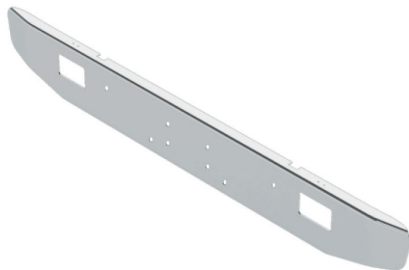

HOB-0010-01



HOB-0000-01



QUALITY TRUCK PARTS

# PETERBILT BUMPERS

AVAILABLE STYLES FOR PRODUCTS ON THIS PAGE:



SET FORWARD AXLE

Width	End Style Code
13"	18
16"	19
18"	20
20"	35

## 362E SET FORWARD AXLE

### HQ



HQ-2210-18      HQ-2200-18

HQ-2010-18      HQ-0210-18

HQ-0010-18      HQ-0200-18

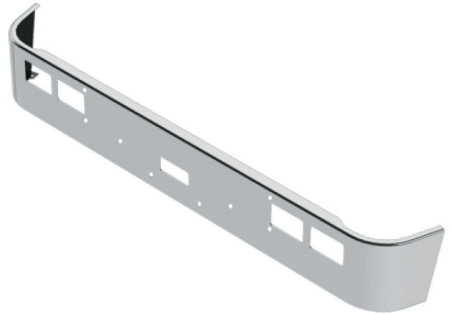

## 377 SET FORWARD AXLE YEARS 1987-1991

### HI

NOTE LETTERS 'HI' IN PART NUMBER

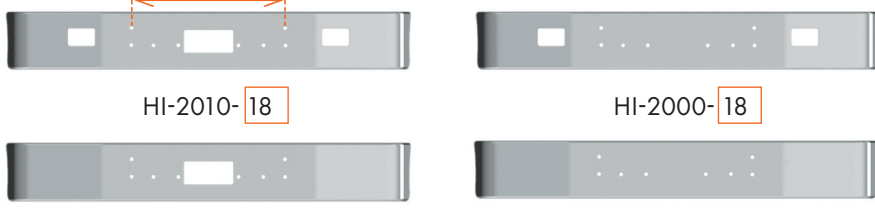

HI-2010-18      HI-2000-18

HI-0010-18      HI-0000-18

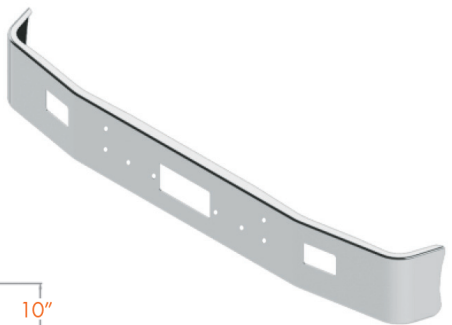
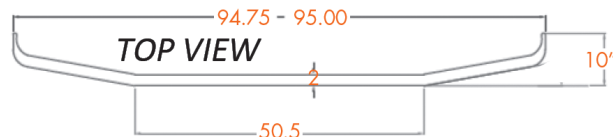

## 377AE, 375 SET FORWARD AXLE YEARS 1987 & NEWER

### HJ

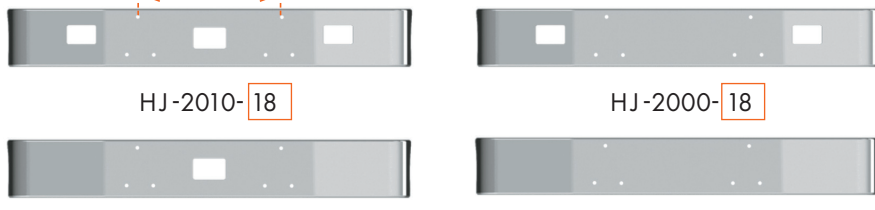

HJ-2010-18      HJ-2000-18

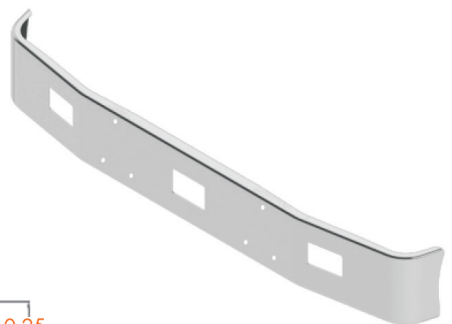
HJ-0010-18      HJ-0000-18



# PETERBILT BUMPERS

AVAILABLE STYLES FOR PRODUCTS ON THIS PAGE:



Width	End Style Code
10"	27
12"	12
14"	25
16"	13
18"	14

## HG

### 357, 378 SETBACK AXLE YEARS 1987-2004

SEE BELOW FOR TOP FLANGE STEP PLATES  
CHECK 'HOD' SERIES PRIOR TO ORDERING

TOP PLATES:







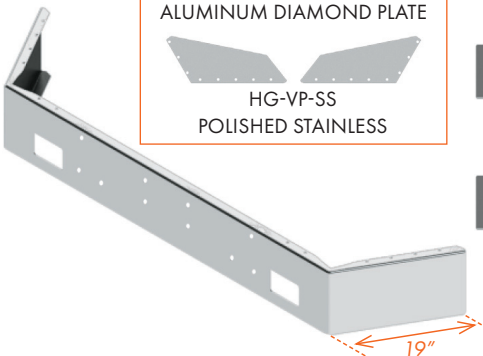

HG-VP-AD  
ALUMINUM DIAMOND PLATE



HG-VP-SS  
POLISHED STAINLESS









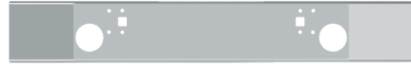
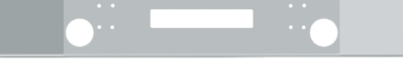
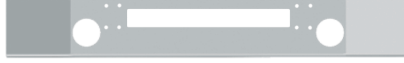

 <p>37.7"</p> <p>HG-2090-12</p>	 <p>HG-2010-12</p>
 <p>HG-2000-12</p>	 <p>HG-0090-12</p>
 <p>HG-0010-12</p>	 <p>HG-0000-12</p>

## HM

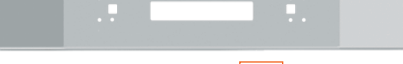
### 320, 520 CABOVER YEARS 1990 & NEWER

AVAILABLE IN 14" ONLY (-25)

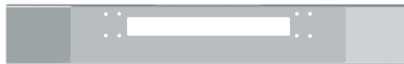
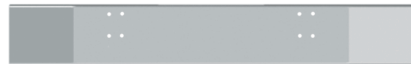
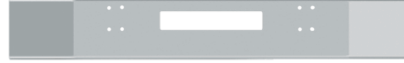
 <p>HM-1011-25</p>	 <p>HM-1012-25</p>	 <p>HM-1010-25</p>
 <p>HM-1001-25</p>	 <p>HM-1002-25</p>	 <p>HM-1000-25</p>
 <p>HM-0011-25</p>	 <p>HM-0012-25</p>	 <p>HM-0010-25</p>
	 <p>HM-0002-25</p>	 <p>HM-0000-25</p>
	 <p>HM-0001-25</p>	

CALL FOR HEATER HOLE OR  
NAT. GAS CUTOUTS

# PETERBILT BUMPERS

AVAILABLE STYLES FOR PRODUCTS ON THIS PAGE:



Width	End Style Code
12"	15
16"	16
18"	17
*20"	34

\* No warranty for 20" wide bumpers

**377 WITH 119" BBC, SET BACK AXLE** YEARS 1987-1997

**HH**

**377AE SET BACK AXLE** YEARS 1990 & OLDER

MOUNTING BRACKETS INCLUDED, CHECK 'HN' SERIES PRIOR TO ORDERING

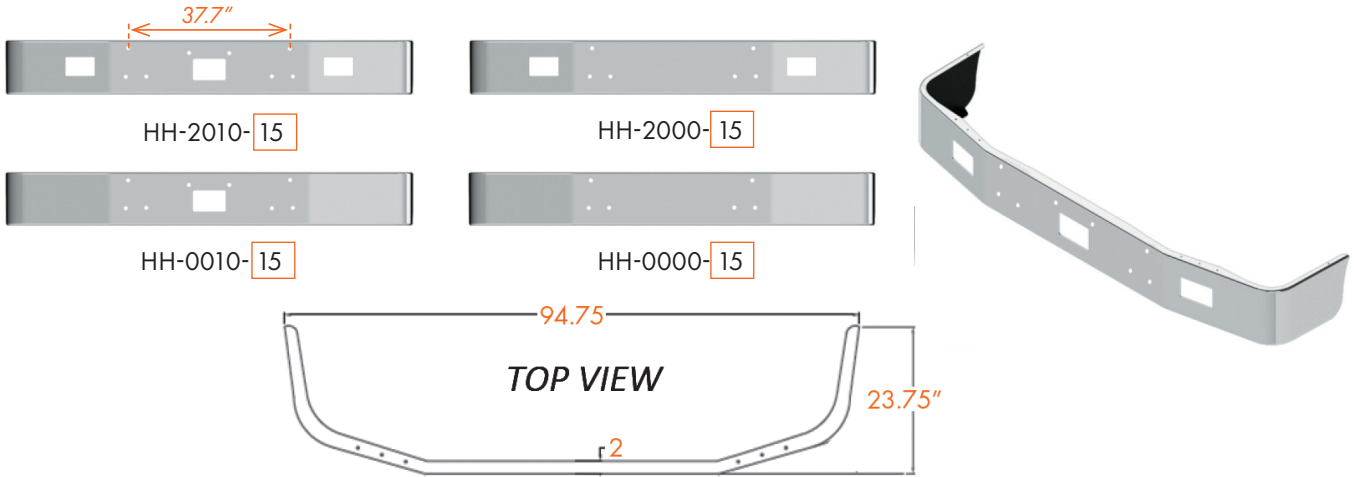

**377 WITH 120" BBC / 122" BBC, SET BACK AXLE**

**HN**

**385 WITH 120" BBC, SET BACK AXLE** YEARS 1997-2007

MOUNTING BRACKETS INCLUDED, CHECK 'HH' SERIES PRIOR TO ORDERING

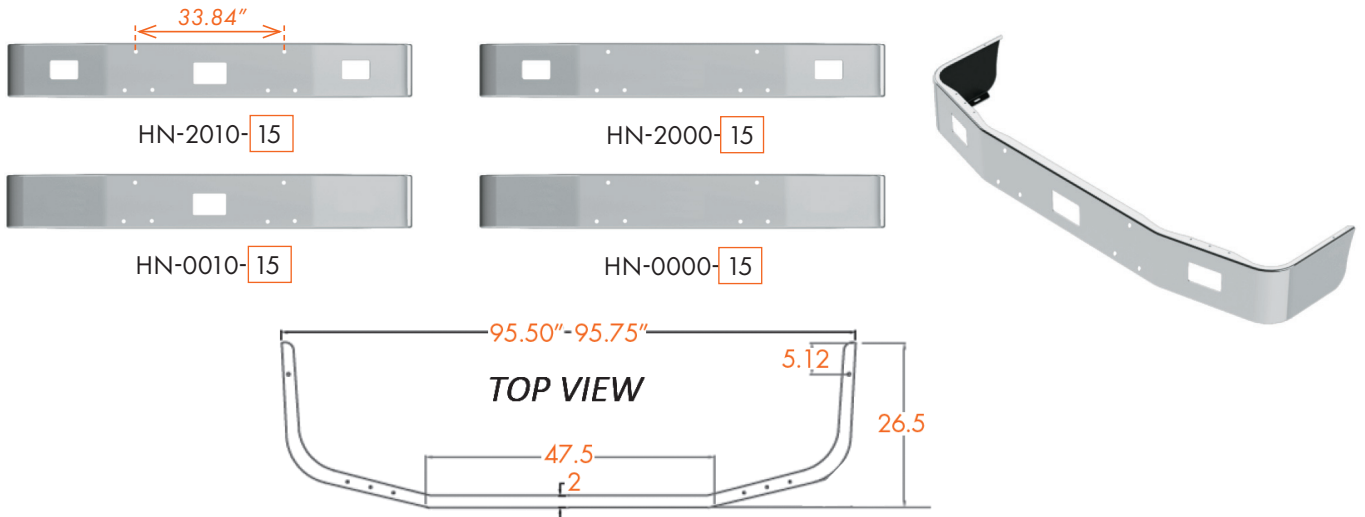

# PETERBILT BUMPERS

AVAILABLE STYLES FOR PRODUCTS ON THIS PAGE:



Width	End Style Code
12"	15
16"	16
18"	17
*20"	34

\* No warranty for 20" wide bumpers

## HL

**385 WITH 112" BBC, SET BACK AXLE** YEARS 1995-2007

CHECK 'HY' SERIES PRIOR TO ORDERING

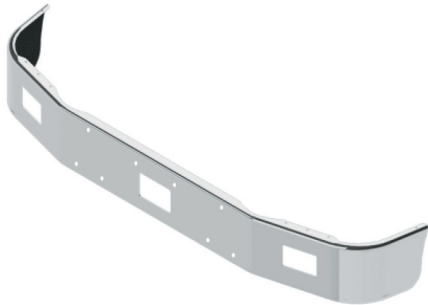

HL-2010-15



HL-2000-15



HL-0010-15



HL-0000-15

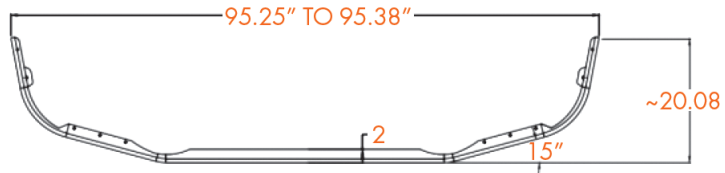

## HY

**385 WITH 120" BBC, SET BACK AXLE** YEARS 1995-2007

CHECK 'HL' SERIES PRIOR TO ORDERING

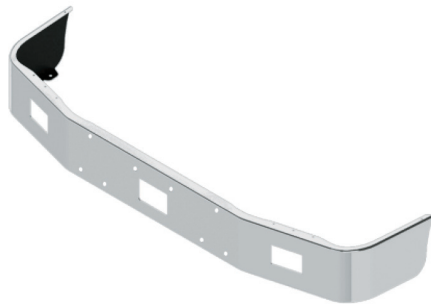

HY-2010-15

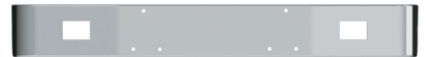

HY-2000-15



HY-0010-15

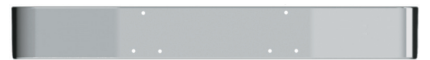

HY-0000-15

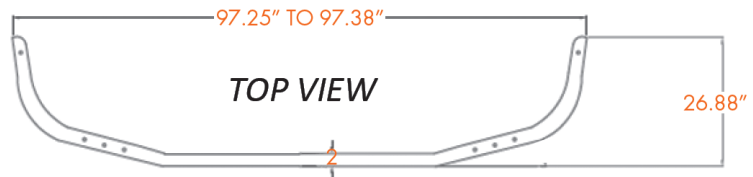

# PETERBILT BUMPERS

AVAILABLE STYLES FOR PRODUCTS ON THIS PAGE:



Width	End Style Code
12"	15
16"	16
18"	17
*20"	34

\* No warranty for 20" wide bumpers

## 357, 378 SET BACK AXLE YEARS 2005-2007

NOTE LETTERS 'HOD' IN PART NUMBER  
CHECK 'HG' SERIES PRIOR TO ORDERING

### HOD

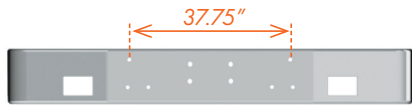

HOD-2090-15



HOD-2010-15



HOD-0090-15



HOD-0010-15



HOD-0000-15



HOD-2000-15

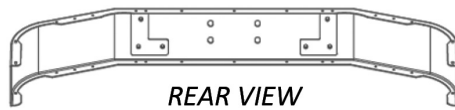

REAR VIEW

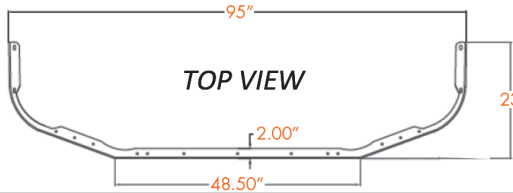

TOP VIEW

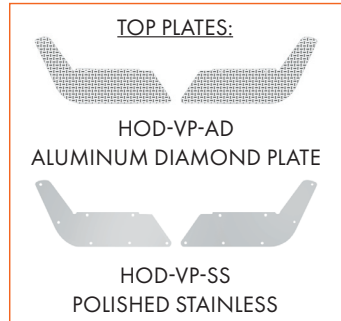

TOP PLATES:

HOD-VP-AD  
ALUMINUM DIAMOND PLATE

HOD-VP-SS  
POLISHED STAINLESS

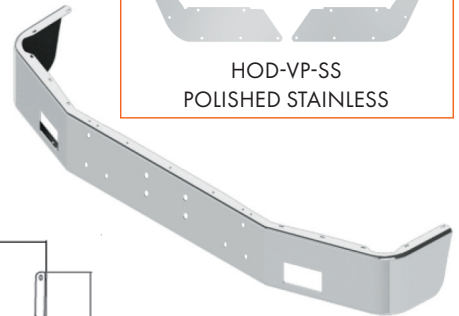

## 367, 567 SET BACK AXLE YEARS 2007 & NEWER

BRACKETS NOT INCLUDED - MOUNTS TO FACTORY BRACKETS  
TWO SETS OF LICENSE PLATE HOLES COME STANDARD

### HX

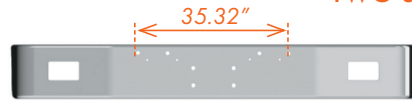

HX-2090-15

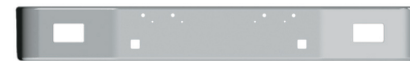

HX-2010-15



HX-0090-15



HX-0010-15

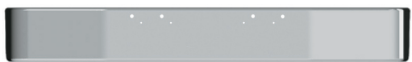

HX-0000-15



HX-2000-15

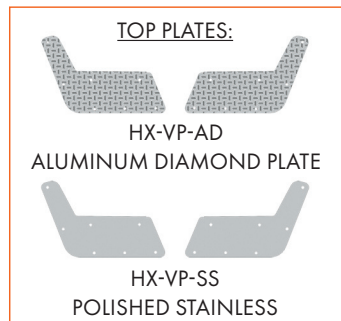

TOP PLATES:

HX-VP-AD  
ALUMINUM DIAMOND PLATE

HX-VP-SS  
POLISHED STAINLESS



REAR VIEW

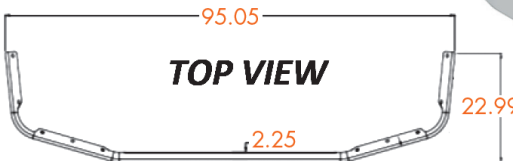

TOP VIEW

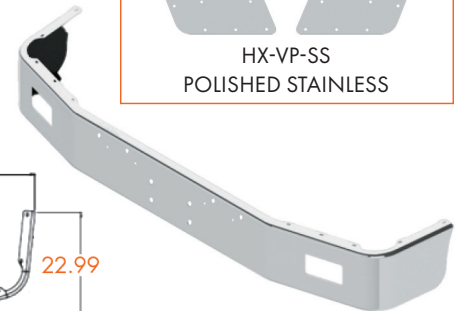

# PETERBILT BUMPERS

AVAILABLE STYLES FOR PRODUCTS ON THIS PAGE:

HP, HOF		HT	
Width	End Style Code	Width	End Style Code
13"	18	14"	15
16"	19	16"	16
18"	20	18"	17
20"	35	*20"	34

\* No warranty for 20" wide bumpers

## HP

### 330 SET FORWARD AXLE YEARS 1998-2005

12K/14K RATED FRONT AXLE

CHECK 'HOF' SERIES PRIOR TO ORDERING  
ONE SET LICENSE PLATE HOLES INCLUDED

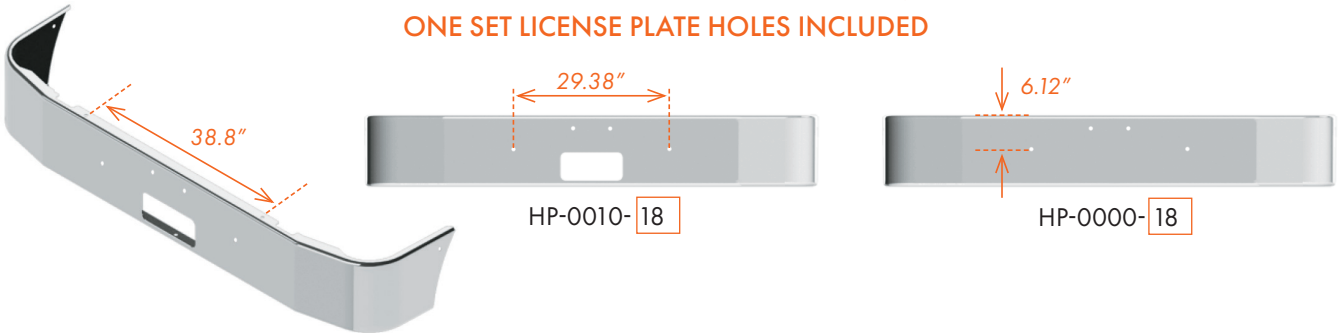

## HOF

### 335HD, 340HD SET FORWARD AXLE YEARS 2006-2014

16K RATED FRONT AXLE

BRACKETS NOT INCLUDED. MOUNTS TO FACTORY BRACKETS.  
NOTE LETTERS 'HOF' IN PART NUMBER. CHECK 'HP' SERIES PRIOR TO ORDERING.

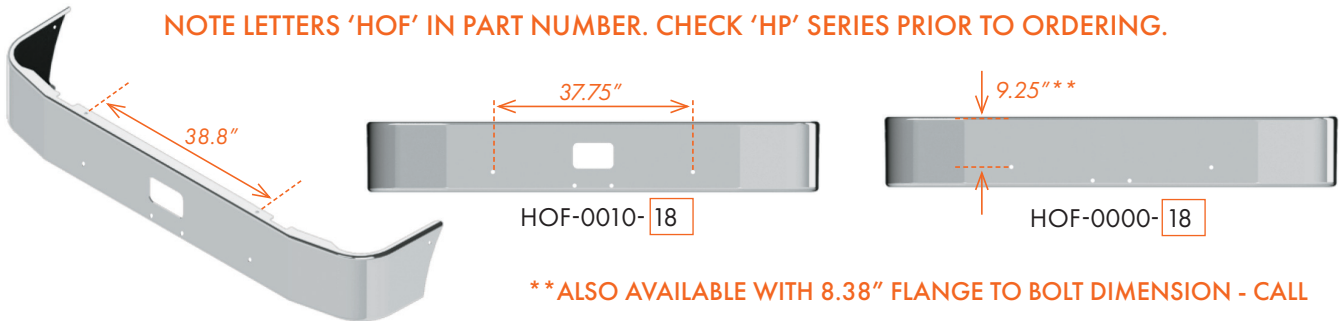

\*\* ALSO AVAILABLE WITH 8.38" FLANGE TO BOLT DIMENSION - CALL

## HT

### 330, 335, 337, 340, 348 SET BACK AXLE YEARS 2006-2014

12K/14K RATED FRONT AXLE

MOUNTING BRACKETS INCLUDED

CHECK 'HOC' SERIES PRIOR TO ORDERING. ONE SET LICENSE PLATE HOLES INCLUDED.

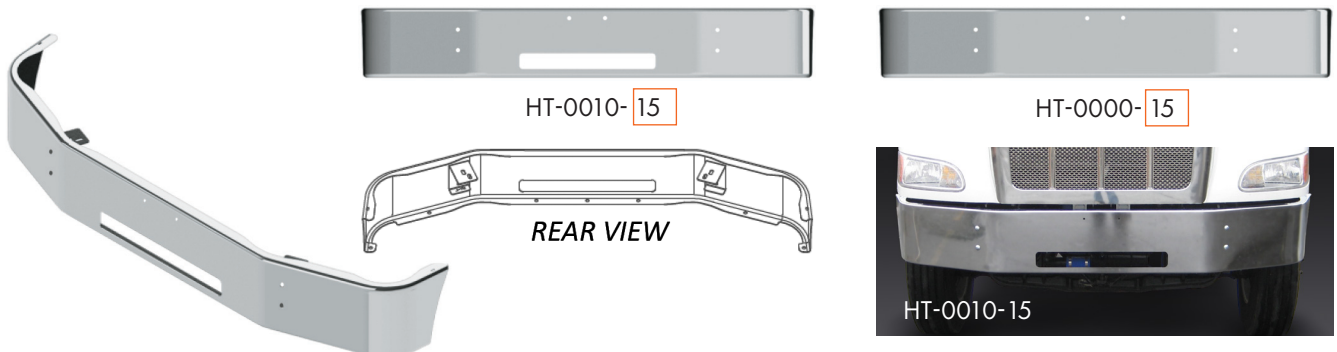

# PETERBILT BUMPERS

AVAILABLE STYLES FOR PRODUCTS ON THIS PAGE:

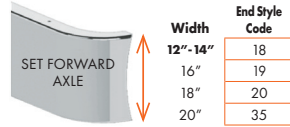

## 337 SET FORWARD AXLE YEARS 2015 & NEWER

MOUNTING BRACKETS INCLUDED  
NOTE LETTERS 'HOC' IN PART NUMBER  
CHECK 'HT' SERIES PRIOR TO ORDERING

### HOC



HOC-2010-18



HOC-2000-18



HOC-0010-18

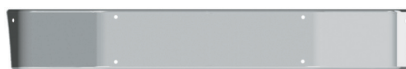

HOC-0000-18

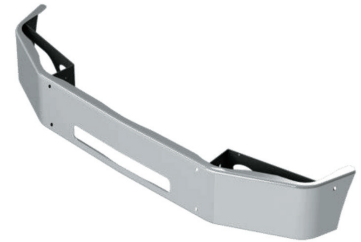
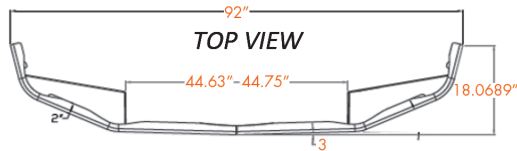

## 348 SET FORWARD AXLE YEARS 2010 & NEWER

NOTE LETTERS 'HOE' IN PART NUMBER

### HOE



HOE-2010-18

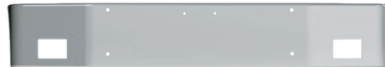

HOE-2000-18



HOE-0010-18



HOE-0000-18

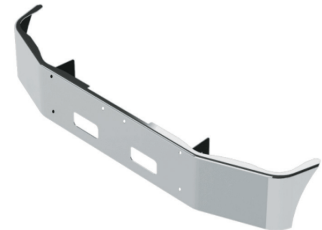

## 536 & 537 SET FORWARD AXLE YEARS 2021-NEWER

MOUNTS TO FACTORY BRACKETS  
(REPLACES FACTORY STEEL ONLY)

### HOG



HOG-0000-18



HOG-5000-18



HOG-0001-18



HOG-5001-18

# PETERBILT BUMPERS

AVAILABLE STYLES FOR PRODUCTS ON THIS PAGE:



Width	End Style Code
16"	16
18"	17
*20"	34

\* No warranty for 20" wide bumpers

## HR

### 387 SET BACK AXLE YEARS 1999-2001

MOUNTING BRACKETS INCLUDED  
AVAILABLE IN 16" TO 20" WIDTHS ONLY



HR-2210-16



HR-2200-16



HR-2010-16



HR-0210-16



HR-0200-16



HR-0010-16



HR-0210-16

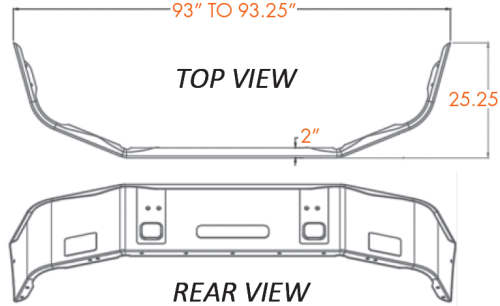

REAR VIEW

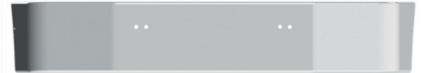

HR-0000-16

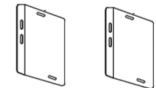

BRACKETS (2)

## HS

### 387 SET BACK AXLE YEARS 2002-2011

MOUNTING BRACKETS INCLUDED  
AVAILABLE IN 16" TO 20" WIDTHS ONLY



HS-2210-16



HS-2200-16



HS-2010-16



HS-0210-16



HS-0200-16



HS-0010-16



HS-2210-16

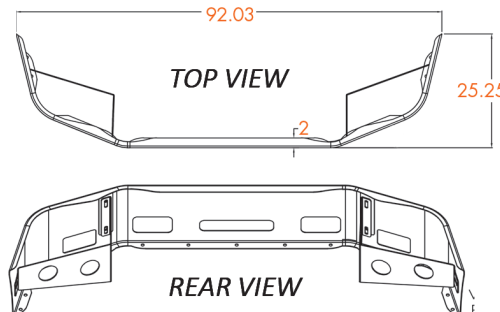

REAR VIEW



HS-0000-16

# PETERBILT BUMPERS

AVAILABLE STYLES FOR PRODUCTS ON THIS PAGE:



Width	End Style Code
13"	15
16"	16
18"	17
*20"	34

SEE DESCRIPTIONS BELOW FOR AVAILABLE WIDTHS

\* No warranty for 20" wide bumpers

## 386 SET BACK AXLE YEARS 2006-2015

REPLACES PLASTIC BUMPERS ONLY  
MOUNTING BRACKETS INCLUDED

AVAILABLE IN 16" TO 20" WIDTHS ONLY

### HU



HU-2210-16



HU-2010-16

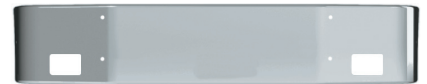

HU-2000-16



HU-0210-16



HU-0010-16



HU-0000-16

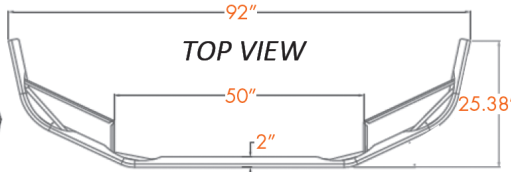
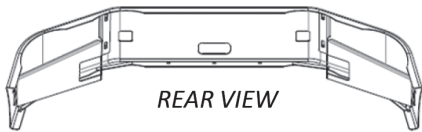

## 384 SET BACK AXLE YEARS 2008-2015

REPLACES STAINLESS CLAD BUMPERS - MOUNTS TO CLAD BRACKETS  
CLAD REPLACEMENT AVAILABLE IN 13" WIDTH ONLY

PLASTIC REPLACEMENT REQUIRES MOUNTING BRACKETS:  
HW0115BK (13") OR HW0116BK (16")

### HW



HW-2011-15

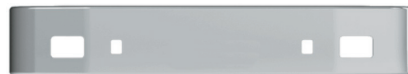

HW-2010-15

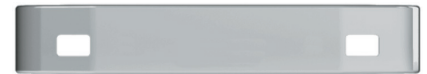

HW-2000-15



HW-0011-15

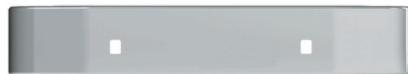

HW-0010-15

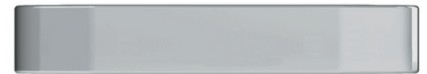

HW-0000-15

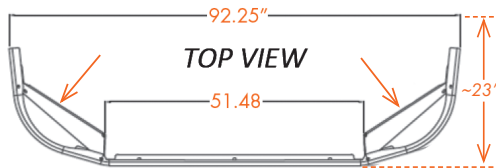
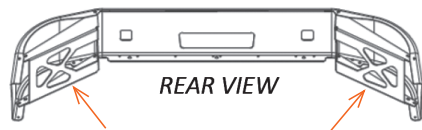

Brackets only for plastic bumper replacement.  
Sold separately.



# PETERBILT BUMPERS

AVAILABLE STYLES FOR PRODUCTS ON THIS PAGE:

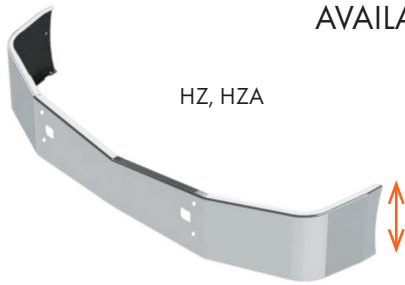

Width	End Style Code
16.5"	16Y
18"	17Y



Width	End Style Code
16"	16
18"	17
*20"	34

\* No warranty for 20" wide bumpers

## HZ

**579 SET BACK AXLE** YEARS 2012-2020  
MOUNTING BRACKETS INCLUDED



HZ-5110-16Y-V4



HZ-5110-16Y



HZ-5100-16Y



HZ-0110-16Y-V4



HZ-0110-16Y



HZ-5010-16Y



HZ-0110-16Y

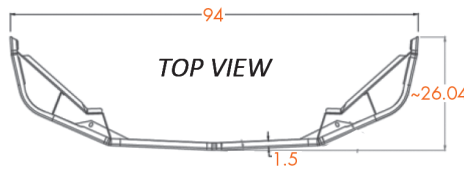

TOP VIEW

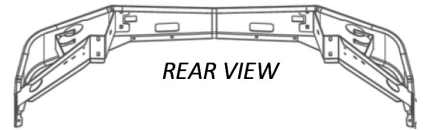

REAR VIEW

## HOA

**587 SET BACK AXLE** YEARS 2012 & NEWER  
NOTE LETTERS 'HOA' IN PART NUMBER. MOUNTING BRACKETS INCLUDED.



HOA-5110-16



HOA-2110-16



HOA-0110-16



HOA-5100-16



HOA-2100-16

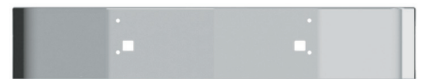

HOA-0010-16



HOA-0100-16



HOA-0210-16



HOA-0000-16



HOA-0010-16

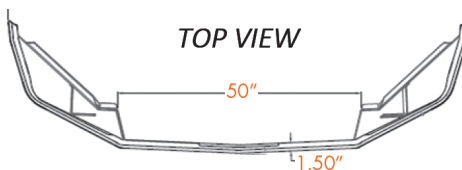

TOP VIEW

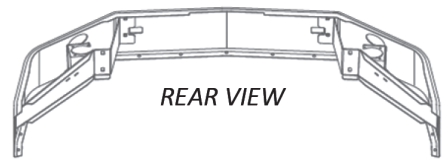

REAR VIEW

# PETERBILT BUMPERS

## HZA

### 579 GEN II SET BACK AXLE

YEARS 2021 & NEWER

MOUNTING BRACKETS INCLUDED

SIMILAR OPTIONS AS 'HZ' SERIES ON PREVIOUS PAGE



HZA-0010-16Y



HZA-0000-16Y



HZA-5010-16Y



HZA-5010-16Y-V4  
(GEN II W/OEM FOGS)



HZA-0010-16Y-V4

# STERLING BUMPERS

AVAILABLE STYLES FOR PRODUCTS ON THIS PAGE:



SET FORWARD AXLE

Width	End Style Code
13"	18
16"	19
18"	20
20"	35

## LT7501 SET FORWARD AXLE YEARS 2000-2009

ONE SET OF UPPER LICENSE PLATE HOLES COME STANDARD  
3/4" SPACERS INCLUDED

### NA



NA-2010-18



NA-2000-18



NA-0010-18



NA-0000-18

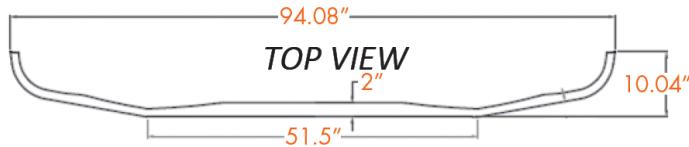
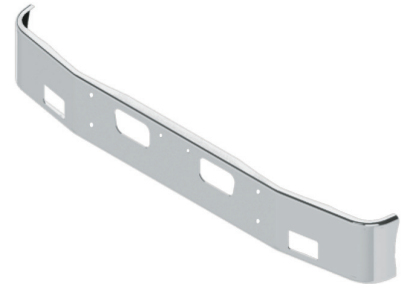

## ACTERRA SET FORWARD AXLE YEARS 2000-2006

MOUNTS TO OEM BRACKETS

### NB



NB-2200-18

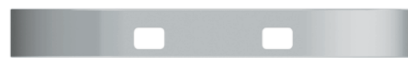

NB-2000-18



NB-0200-18

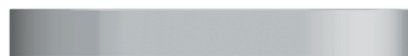

NB-0000-18

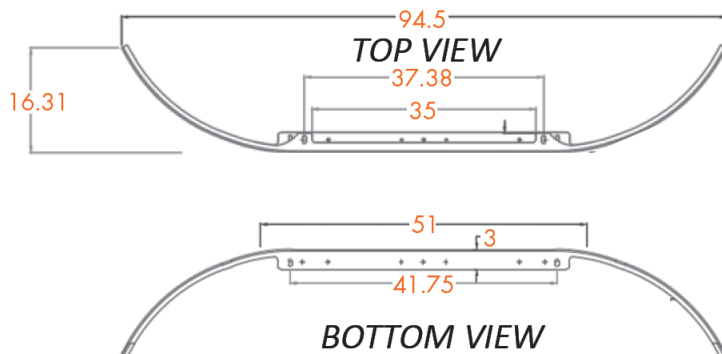

# STERLING BUMPERS

AVAILABLE STYLES FOR PRODUCTS ON THIS PAGE:



Width	End Style Code
12"	15
16"	16
18"	17
*20"	34

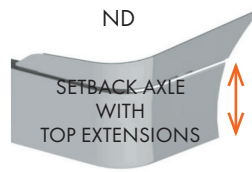

Width	End Style Code
12"	15X
16"	16X
18"	17X
*20"	34X

\* No warranty for 20" wide bumpers

## NC

### STERLING LT9500, LT9513, FORD L-SERIES

YEARS 1996-2009

MOUNTING BRACKETS INCLUDED. ONE SET LICENSE PLATE HOLES STANDARD.

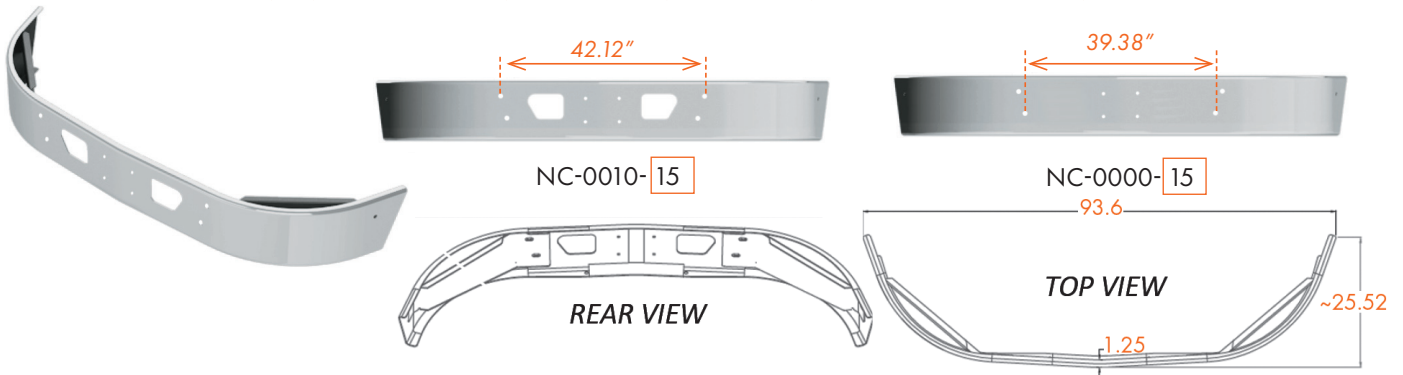

Add "P" to the end of our part number for a black powder coated bumper

## ND

### STERLING AT9500 YEARS 1996-2009

MOUNTING BRACKETS INCLUDED

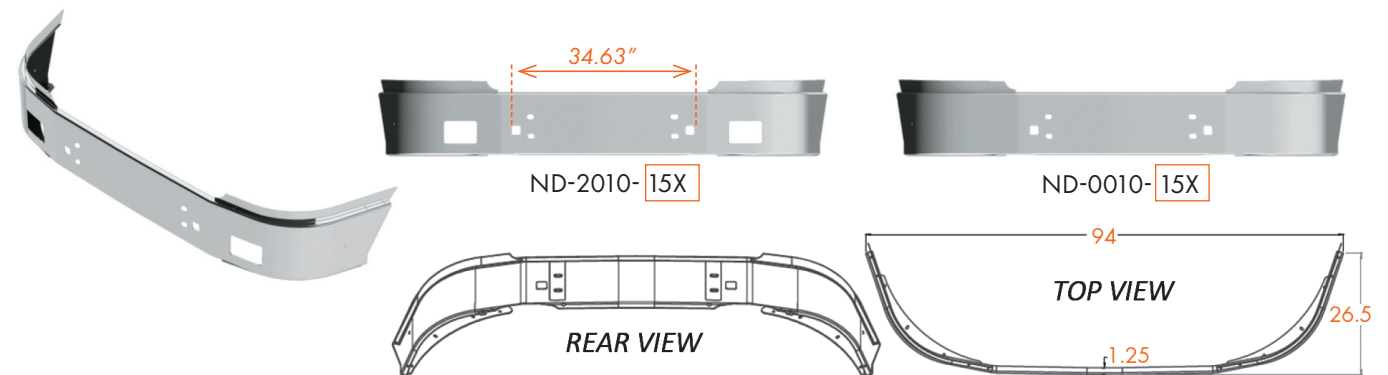

Add "P" to the end of our part number for a black powder coated bumper

# VOLVO BUMPERS

AVAILABLE STYLES FOR PRODUCTS ON THIS PAGE:



Width	End Style Code
12"	15
16"	16
18"	17
*20"	34

LA = 13"

\* No warranty for 20" wide bumpers

## WA, WIA SET BACK AXLE YEARS 1988-1997

MOUNTING BRACKETS INCLUDED

### LA

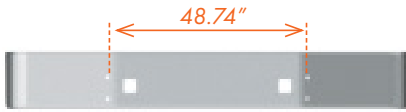

LG-0010-15



LG-0000-15

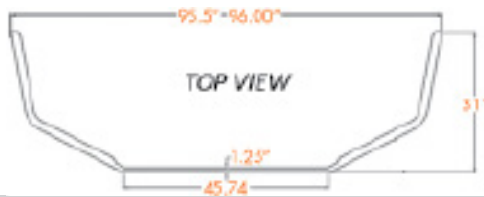

## VNM SET BACK AXLE YEARS 1998-2003

MOUNTING BRACKETS INCLUDED

### LD



LD-0011-15



LD-0010-15



LD-0001-15



LD-0000-15

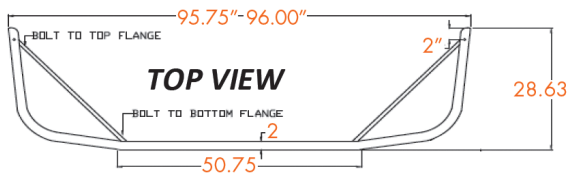

LD-0011-15

## VNM SET BACK AXLE YEARS 2004-2017

MOUNTING BRACKETS INCLUDED

### LG



LG-5011-15



LG-0011-15

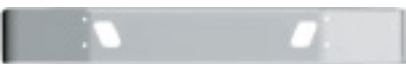

LG-0010-15

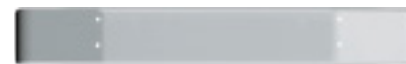

LG-0000-15

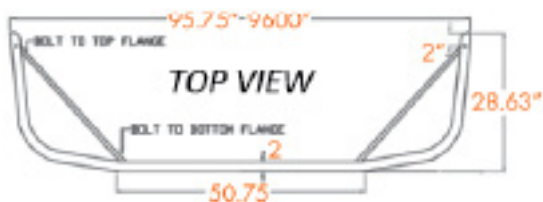

LG-0011-15

# VOLVO BUMPERS

AVAILABLE STYLES FOR PRODUCTS ON THIS PAGE:

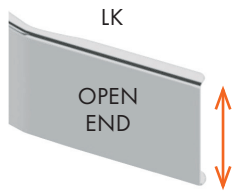

Width	End Style Code
12"	12
14"	25
16"	13
18"	14
20"	61

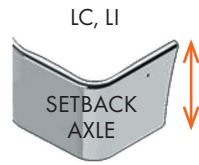

Width	End Style Code
13"	15
16"	16
18"	17
*20"	34

← 'LI' ONLY AVAILABLE IN - 17 & 34

\* No warranty for 20" wide bumpers

## LK

### WG DAYCAB SET FORWARD AXLE YEARS 1991-2001

SEE 'LC' SERIES FOR NON-DAYCAB

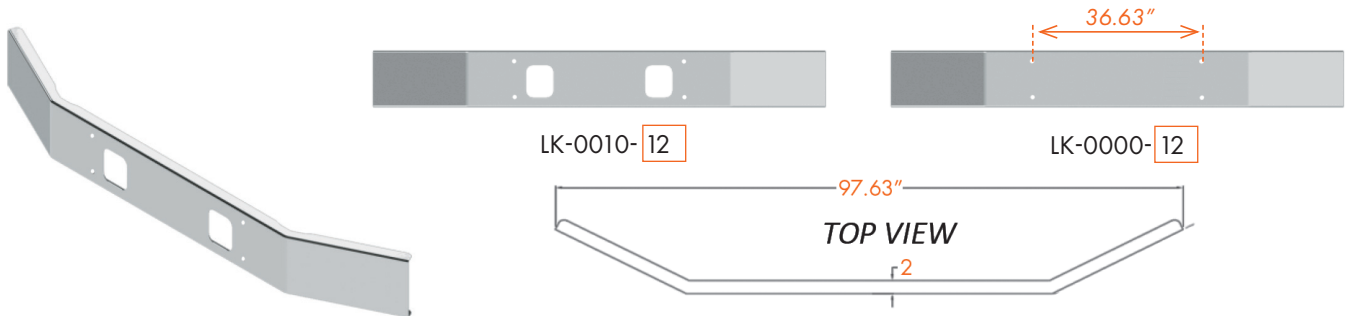

## LC

### WG SET BACK AXLE YEARS 1991-2001

MOUNTING BRACKETS INCLUDED

SEE 'LK' SERIES FOR DAYCAB

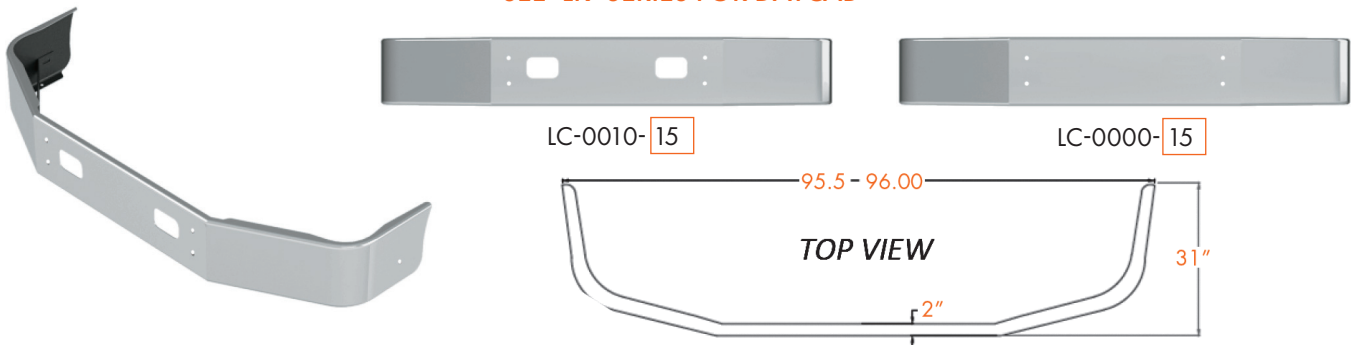

## LI

### VT SERIES SET BACK AXLE YEARS 2006-2008

NOTE LETTERS 'LI' IN PART NUMBER

ONLY AVAILABLE IN 18" AND 20" WIDTHS

ONE SET UPPER LICENSE PLATE HOLES COME STANDARD

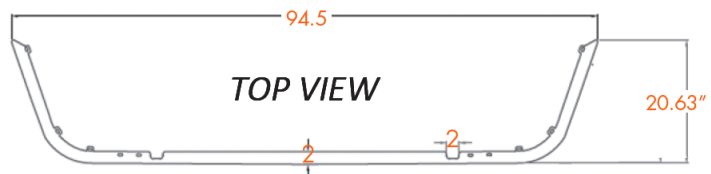

# VOLVO BUMPERS

AVAILABLE STYLES FOR PRODUCTS ON THIS PAGE:

Width	End Style Code
16"	02
18"	03
20"	31
22"	32

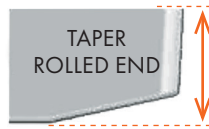

## VOLVO WHITE WCA YEARS 1987-2001

**LF**

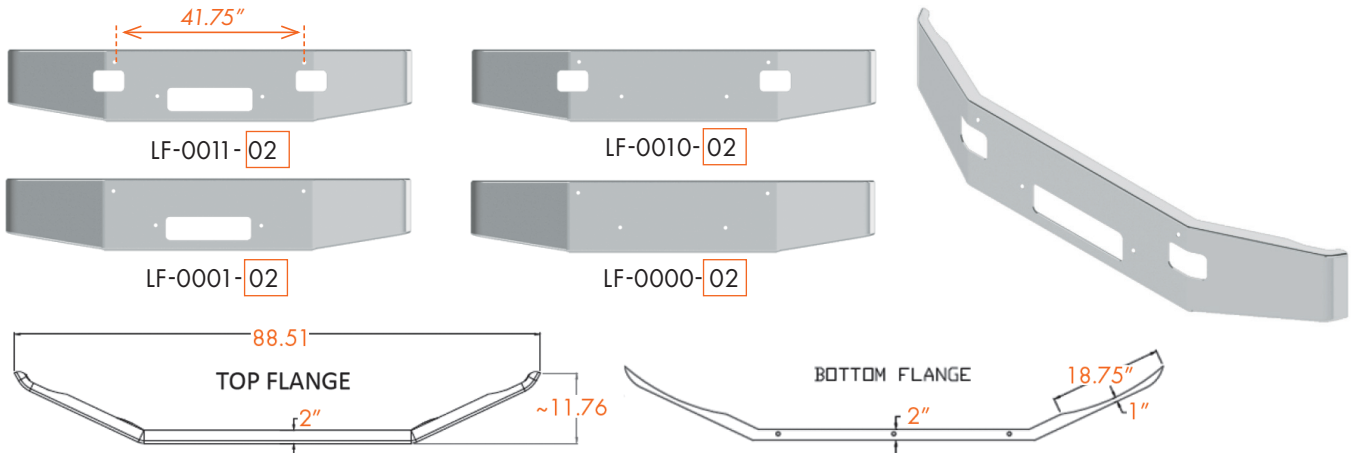

## VHD SERIES SET FORWARD AXLE YEARS 2005-2021

MOUNTING BRACKETS AND BLACK POWDER COATED GRILLE FILLER INCLUDED  
NOT AVAILABLE WITHOUT VENT HOLES

**LM**

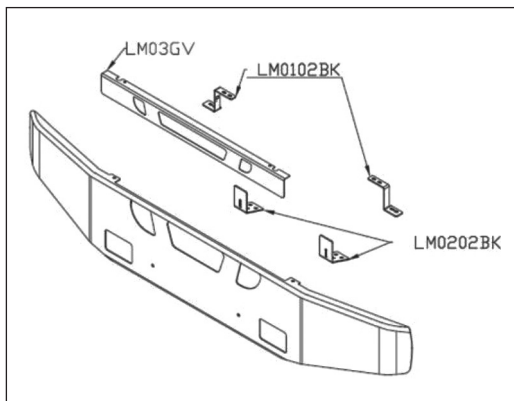

OPTIONAL STAINLESS GRILLE FILLER:

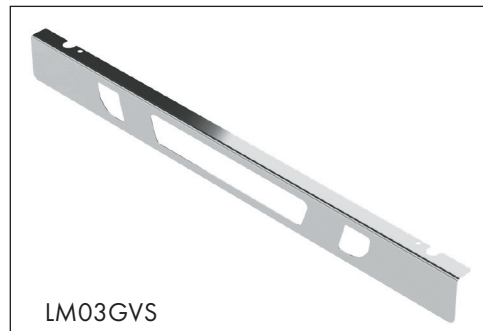

# VOLVO BUMPERS

AVAILABLE STYLES FOR PRODUCTS ON THIS PAGE:



**Width**  
 12"-13"  
 16"  
 18"  
 \*20"

**End Style Code**

15
16
17
34

← LB = 13" / LE = 12"

\* No warranty for 20" wide bumpers

## LB

### VNL SET BACK AXLE YEARS 1996-2003

REPLACES PLASTIC/FIBERGLASS BUMPERS ONLY

MOUNTING BRACKETS INCLUDED

SEE 'LE' SERIES FOR REPLACING STAINLESS CLAD BUMPERS

MUST BE 16" (16) FOR FOG LIGHT OPTIONS

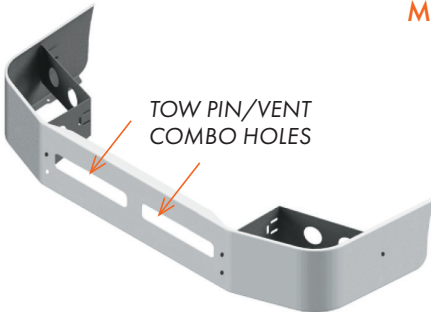

LB-0010-15



LB-0000-15



LB-4010-16



LB-2010-16



LB-0010-16

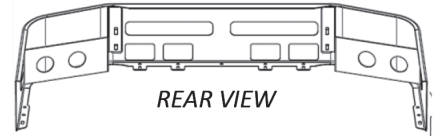
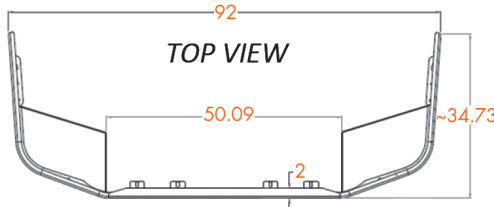

## LE

### VNL SET BACK AXLE YEARS 1996-2003

REPLACES STAINLESS CLAD BUMPERS ONLY

MOUNTING BRACKETS INCLUDED

SEE 'LB' SERIES FOR REPLACING PLASTIC/FIBERGLASS BUMPERS

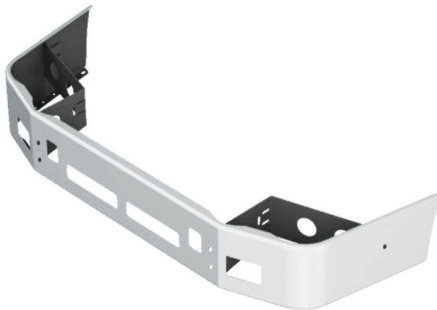

LE-2011-15



LE-2010-15



LE-0011-15



LE-0010-15



LE-2011-15

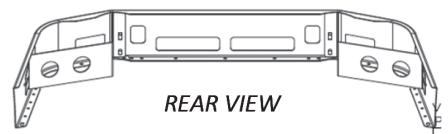
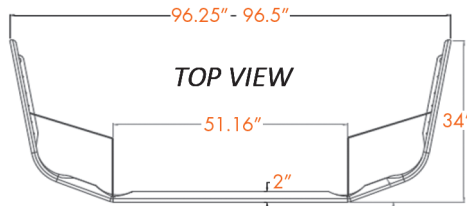



# VOLVO BUMPERS

AVAILABLE STYLES FOR PRODUCTS ON THIS PAGE:



Width	End Style Code
14"	15
16"	16
18"	17
*20"	34

\* No warranty for 20" wide bumpers

## VNL SET BACK AXLE YEARS 2004-2017 MOUNTING BRACKETS INCLUDED

# LH



LH-5011-15  
OEM fog lights, tow pins, vent holes



LH-2011-15  
Rectangular fog lights, tow pins, vent holes



LH-5010-15  
OEM fog lights, tow pin holes

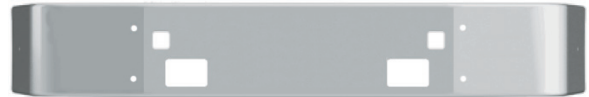

LH-2010-15  
Rectangular fog lights, tow pin holes



LH-0011-15  
Tow pin holes, vent hole

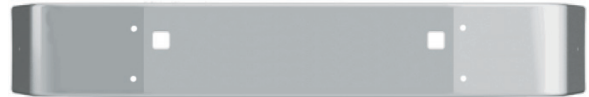

LH-0010-15  
Tow pin holes



LH-0000-15  
Mounting bolts only

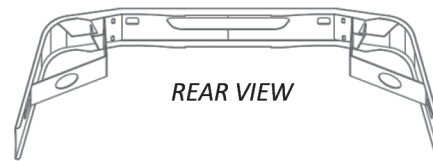
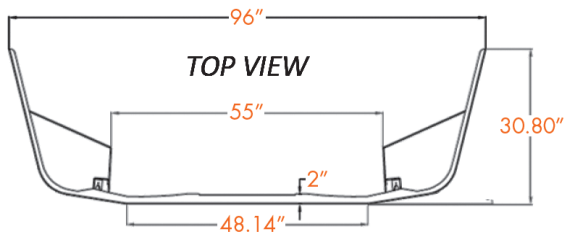

# VOLVO BUMPERS

AVAILABLE STYLES FOR PRODUCTS ON THIS PAGE:



Width	End Style Code
14"	15
16"	16
18"	17
*20"	34

\* No warranty for 20" wide bumpers

## LJ

### VNR SET BACK AXLE YEARS 2018 & NEWER MOUNTING BRACKETS INCLUDED



LJ-5011-15



LJ-5010-15



LJ-5001-15



LJ-0011-15

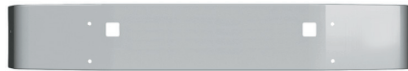

LJ-0010-15

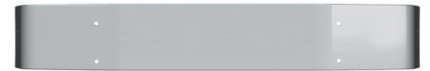

LJ-0000-15

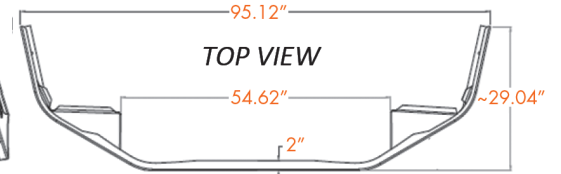
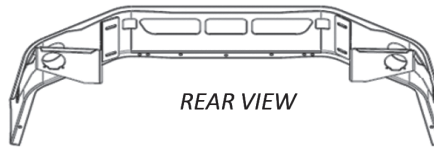

## LL

### VNL SET BACK AXLE YEARS 2018 & NEWER MOUNTING BRACKETS INCLUDED



LL-5011-15



LL-5010-15



LL-5001-15



LL-0011-15



LL-0010-15



LL-0000-15

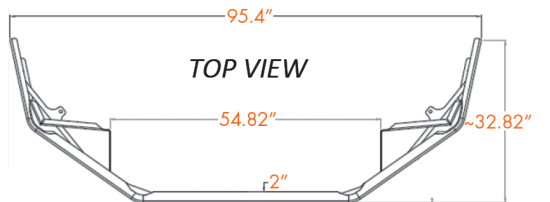
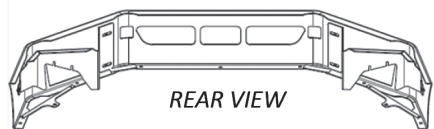

# WESTERN STAR BUMPERS

EXAMPLE STYLES FOR PRODUCTS ON THIS PAGE:

End Style Code	Width	End Style Code	Width	End Style Code	Width	End Style Code
01	12"	09	12"	04	12"	04
02	16"	10	16"	05	16"	05
03	18"	11	18"	06	18"	06
31	20"	51	20"	41	20"	41
32	22"	52	22"	42	22"	42

## CABOVER YEARS 1977-1980

NOTE LETTERS 'IA' IN PART NUMBER  
NOT AVAILABLE IN 12" WIDTH

### IA



IA-1110-02



IA-1100-02



IA-1010-02



IA-0110-02

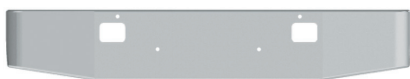

IA-0100-02

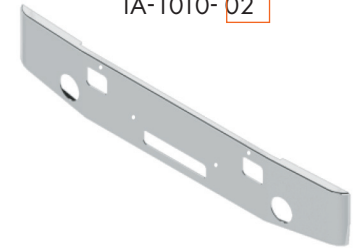

IA-0010-02

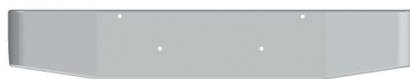

IA-0000-02

## CONVENTIONAL YEARS 1967-1984

NOTE LETTERS 'IB' IN PART NUMBER

### IB



IB-1010-02



IB-1000-02



IB-0010-02



IB-2010-02

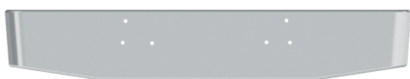

IB-0000-02

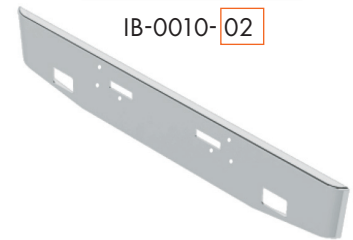

## CONVENTIONAL YEARS 1985-1988

NOTE LETTERS 'IF' IN PART NUMBER

### IF



IF-2010-02



IF-2000-02



IF-0010-02



IF-0000-02

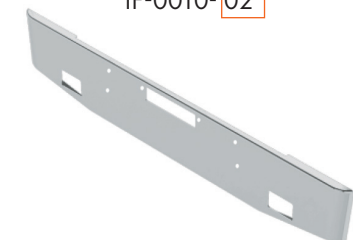

# WESTERN STAR BUMPERS

EXAMPLE STYLES FOR PRODUCTS ON THIS PAGE:

Width	End Style Code	Width	End Style Code	Width	End Style Code
12"	01	12"	09	12"	04
16"	02	16"	10	16"	05
18"	03	18"	11	18"	06
20"	31	20"	51	20"	41
22"	32	22"	52	22"	42

## IC 4900SF, 4900EX, CONSTELLATION, LOWMAXX, HERITAGE YEARS 1989-2007 AND SIMILAR CHASSIS. NOTE LETTERS 'IC' IN PART NUMBER.



## IH 4900SF YEARS 2008 & NEWER NOT AVAILABLE IN 12" WIDTH. NOTE LETTERS 'IH' IN PART NUMBER.

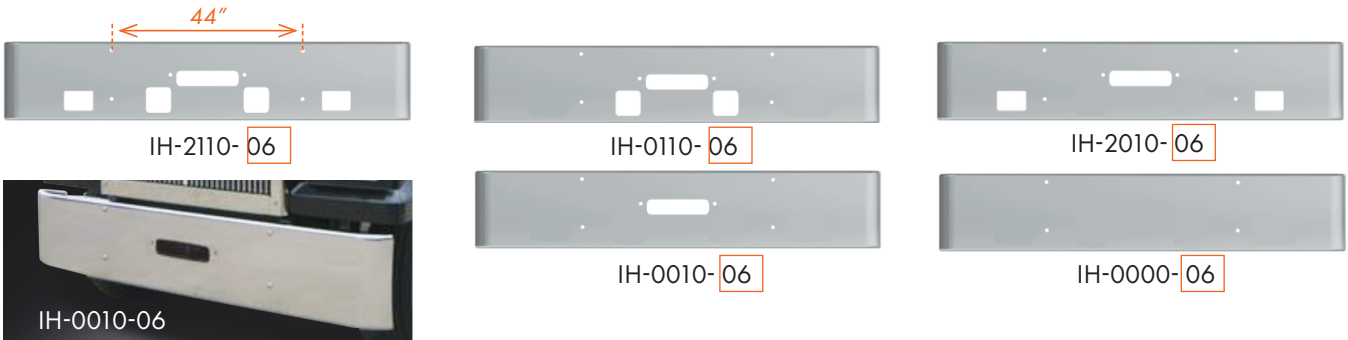

## IM 4700SF YEARS 2008 & NEWER NOT AVAILABLE IN 12" WIDTH. NOTE LETTERS 'IM' IN PART NUMBER.

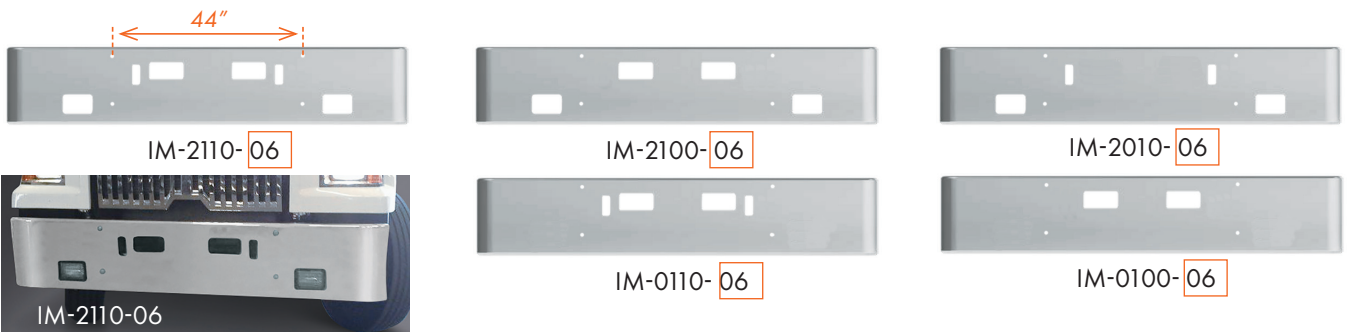

# WESTERN STAR BUMPERS

AVAILABLE STYLES FOR PRODUCTS ON THIS PAGE:



Width	End Style Code
14"	44
16"	45
18"	46
*20"	47
*22"	48

\* No warranty for 20" or 22" wide bumpers

## 4900SA YEARS 1989-2007 NOTE LETTERS 'II' IN PART NUMBER

II

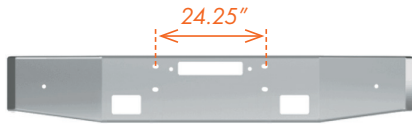

II-2010-44



II-0010-44



II-2000-44



II-0000-44

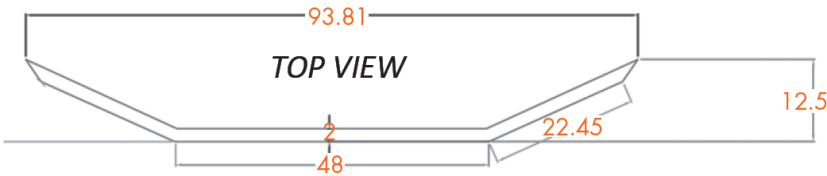
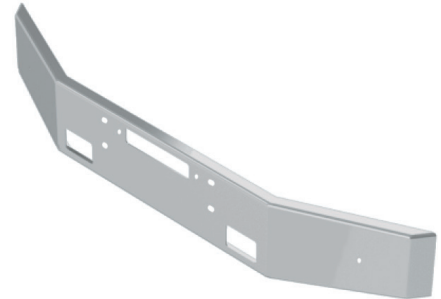

II-0010-44

## 4900SA YEARS 2008 & NEWER NOTE LETTERS 'IJ' IN PART NUMBER ALSO CHECK 'IK' AND 'IL' SERIES PRIOR TO ORDERING

IJ

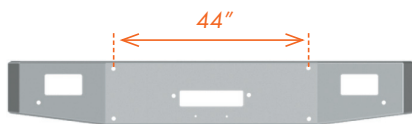

IJ-2010-44

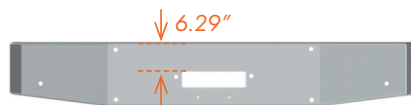

IJ-0010-44



IJ-2000-44



IJ-0000-44

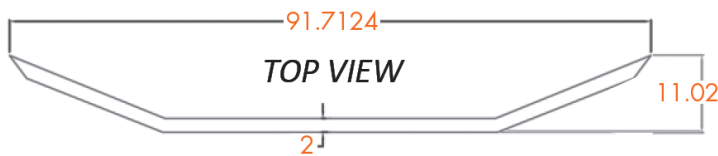
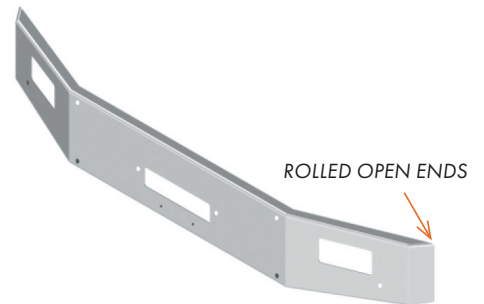

IJ-2010-44

# WESTERN STAR BUMPERS

AVAILABLE STYLES FOR PRODUCTS ON THIS PAGE:

	<b>IK, IL</b>	<table border="1"> <thead> <tr> <th>Width</th> <th>End Style Code</th> </tr> </thead> <tbody> <tr><td>14"</td><td>44</td></tr> <tr><td>16"</td><td>45</td></tr> <tr><td>18"</td><td>46</td></tr> <tr><td>*20"</td><td>47</td></tr> <tr><td>*22"</td><td>48</td></tr> </tbody> </table>	Width	End Style Code	14"	44	16"	45	18"	46	*20"	47	*22"	48		<table border="1"> <thead> <tr> <th>Width</th> <th>End Style Code</th> </tr> </thead> <tbody> <tr><td>14"</td><td>15</td></tr> <tr><td>16"</td><td>16</td></tr> <tr><td>18"</td><td>17</td></tr> </tbody> </table>	Width	End Style Code	14"	15	16"	16	18"	17
	Width		End Style Code																					
	14"		44																					
	16"		45																					
	18"		46																					
*20"	47																							
*22"	48																							
Width	End Style Code																							
14"	15																							
16"	16																							
18"	17																							
14"	44																							
16"	45																							
18"	46																							
*20"	47																							
*22"	48																							

\* No warranty for 20" or 22" wide bumpers

## IK

**4900SA** YEARS 2008 & NEWER

NOTE LETTERS 'IK' IN PART NUMBER

ALSO CHECK 'IJ' AND 'IL' SERIES PRIOR TO ORDERING

<p>IK-2010-44</p>	<p>IK-0010-44</p>
<p>IK-2000-44</p>	<p>IK-0000-44</p>

## IL

**4900SA** YEARS 2008 & NEWER

NOTE LETTERS 'IL' IN PART NUMBER

ALSO CHECK 'IJ' AND 'IK' SERIES PRIOR TO ORDERING

<p>IL-2010-44</p>	<p>IL-0010-44</p>
<p>IL-2000-44</p>	<p>IL-0000-44</p>

## IN

**4700SB** YEARS 2013 & NEWER

NOTE LETTERS 'IN' IN PART NUMBER

<p>IN-2010-15</p>	<p>IN-0010-15</p>
<p>IN-0000-15</p>	<p>IN-0010-15</p>

# WESTERN STAR BUMPERS

AVAILABLE STYLES FOR PRODUCTS ON THIS PAGE:

Width	End Style Code
16"	708
18"	709
*20"	711

*\* No warranty for 20" wide bumpers*

## 5700XE YEARS 2015 & NEWER

# IO

ONLY FITS STANDARD WIDTH FRAMES WITH ~1400 SQ. INCH RADIATORS  
MOUNTING BRACKETS AND TOP FLANGE STAINLESS EXTENSIONS INCLUDED

NOTE LETTERS 'IO' IN PART NUMBER



IO-5010-708-V5  
Fogs, tow pins, radar accommodation



IO-5000-708-V5  
Fogs, radar accommodation



IO-0010-708-V5  
Tow pins, radar accommodation



IO-0000-708-V5  
Radar accommodation only



IO-0010-708  
Tow pin holes



IO-0000-708  
Mounting holes only

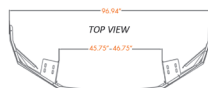

Width	End Style Code	AVAILABLE STYLES FOR PRODUCTS IN THIS SECTION:	Width	End Style Code
16"	45	<p>IR, IS</p> <p>OPEN END W/TAPER</p>	16"	05
18"	46		18"	06
*20"	47		20"	41
*22"	48		22"	42
			<p>* No warranty for 20" or 22" wide bumpers</p>	
		<p>IQ, IT</p> <p>SQUARE ROLLED END</p>		
			12"	01
			16"	02
			18"	03
			20"	31
		22"	32	

## 47X SET FORWARD AXLE YEARS 2022-NEWER

# IQ



IQ-0010-02

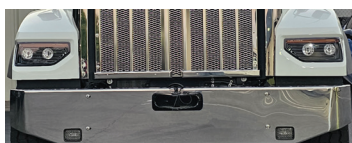

IQ-5210-02



IQ-0030-02



IQ-5330-02

## 49X SETBACK AXLE 5D YEARS 2021-NEWER

# IR

Only (-45) End Style Mounts to Factory Brackets



IR-0011-45



IR-5112-45



IR-3000-45



IR-3520-45

## 47X SETBACK AXLE YEARS 2022-NEWER

# IS

Only (-45) End Style Mounts to Factory Brackets



IS-5110-45



IS-5030-45



IS-3520-45



IS-0520-45

# WESTERN STAR BUMPERS CONTD'

**IT**

Width	End Style Code	IQ, IT TAPER HAND FORM
16"	92	
18"	03	
20"	31	
22"	32	

AVAILABLE STYLES FOR THIS SERIES ALSO ON PREVIOUS PAGE

## 49X SET FORWARD AXLE YEARS 2021-NEWER

\* No warranty for 20" or 22" wide bumpers

Width	End Style Code	IT AMERICAN EAGLE BOXED END
16"	55	WITH 8" EARS
18"	56	
20"	57	
22"	58	



IT-0000-92

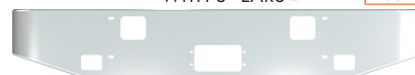

IT-5330-92



IT-0220-92



IT-5221-92

## WHITE BUMPERS

AVAILABLE STYLES FOR PRODUCTS ON THIS PAGE:

KA		KA		KB		
Width	End Style Code	Width	End Style Code	Width	Bumper Length	End Style Code
16"	02	16"	05	12"	94"	22
18"	03	18"	06	12"	88"	22-88"
20"	31	20"	41			
22"	32	22"	42			

**KA**

## ROAD BOSS 2, ROAD COMMANDER 2

YEARS 1972-1983

NOT AVAILABLE IN 12" WIDTH

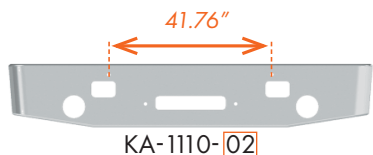

KA-1110-02

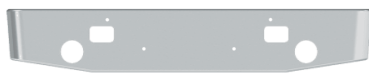

KA-1100-02



KA-1010-02

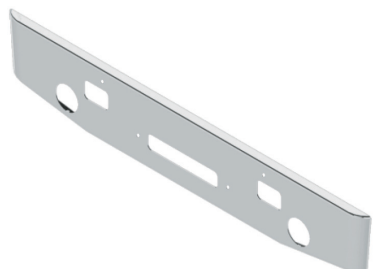

KA-0110-02

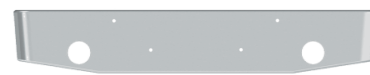

KA-1000-02



KA-0100-02



KA-0010-02



KA-0000-02

**KB**

## XPEDITOR YEARS 2003-2010

NOTE OUTSIDE SHAPE & BOLT PATTERN PRIOR TO ORDERING



KB-1010-22

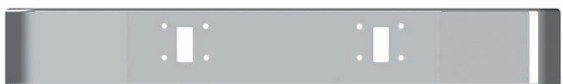
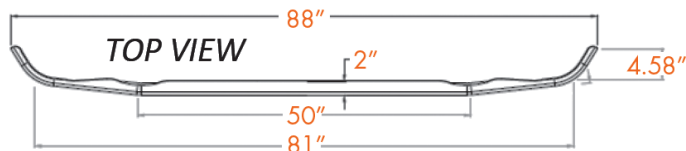

KB-0010-22



KB-0010-22P

Add "P" to end of any bumper part number for black powder coated steel



# "UNIVERSAL" MOUNT BLANK BUMPERS

EXAMPLE STYLES FOR PRODUCTS ON THIS PAGE:

TAPER ROLLED END	Width	End Style Code
	16"	02
18"	03	
20"	31	
22"	32	

SQUARE ROLLED END	Width	End Style Code
	16"	05
18"	06	
20"	41	
22"	42	

SQUARE BOXED END	Width	End Style Code
	16"	10
18"	11	
20"	51	
22"	52	

ROADRUNNER	Width	End Style Code
	16"	112
18"	113	
20"	114	
22"	115	

AMERICAN EAGLE ROLLED END	Width	End Style Code
	16"	65
18"	66	
20"	67	
22"	68	

AMERICAN EAGLE BOXED END	Width	End Style Code
	16"	55
18"	56	
20"	57	
22"	58	

SEE MORE BUMPER STYLES ON PAGE 7

## MULTIPLE MAKE & MODEL FIT

NOTE LETTERS 'GO' IN PART NUMBER

EXAMPLE PARTS:

**GO**

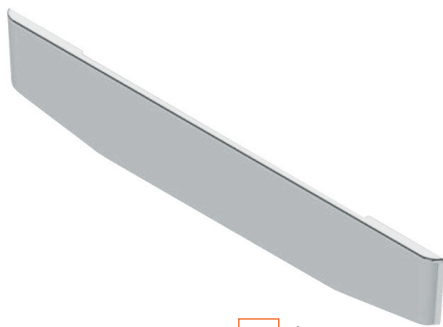

GO-0000-02 chrome  
GO-0000-02S stainless

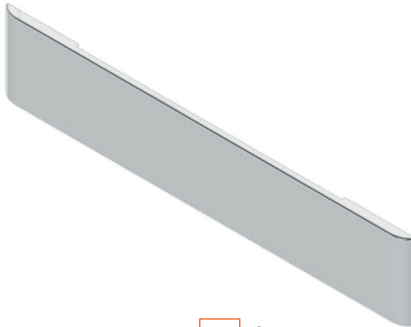

GO-0000-06 chrome  
GO-0000-06S stainless

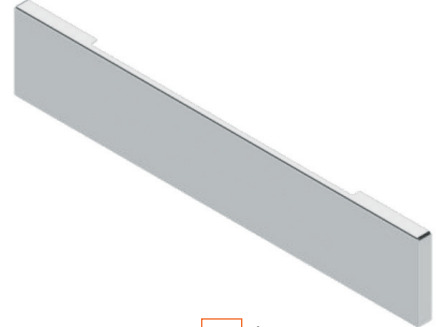

GO-0000-11 chrome  
GO-0000-11S stainless

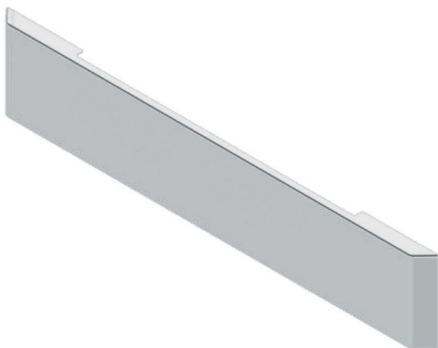

GO-0000-113 chrome  
GO-0000-113S stainless

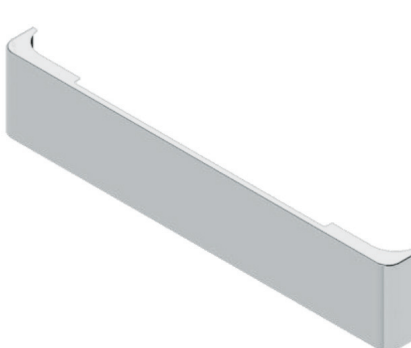

GO-0000-66 chrome  
GO-0000-66S stainless

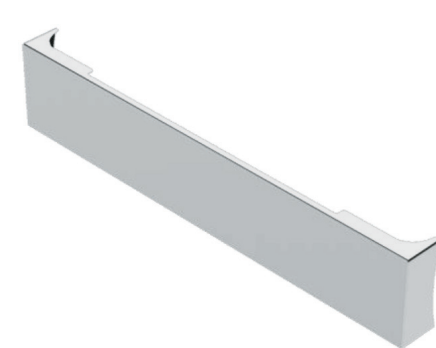

GO-0000-56 chrome  
GO-0000-56S stainless

**NOTE: DRILLING INTO A CHROME BUMPER IMMEDIATELY VOIDS ALL WARRANTIES.  
WE RECOMMEND STAINLESS BUMPERS IF PLANNING TO DRILL INTO A BUMPER.**

# BLIND MOUNT BUMPERS

## BLIND MOUNT BRACKETS:

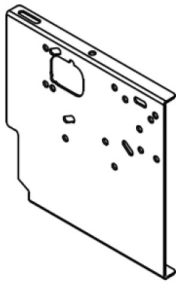

**-UST**

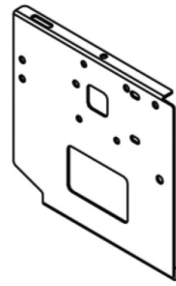
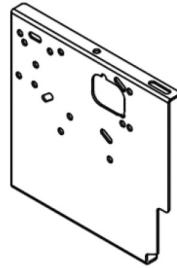

**-USX**

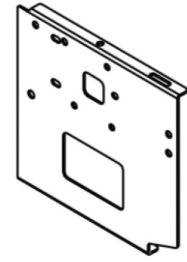

FITS THESE VALLEY CHROME MODEL CODES:  
**CB, CQ, FD, FE, HA, HC, GO**

FITS THESE VALLEY CHROME MODEL CODES:  
**CU, CV, HC, HV, IC, GO**



**UST TOP FLANGE**



**USX TOP FLANGE**

## HOW TO CREATE A BLIND MOUNT BUMPER:

1. IDENTIFY YOUR MAKE & MODEL CODE FROM OUR CATALOG (EXAMPLE: PETE 389= 'HV')
2. CHOOSE YOUR CUTOUTS:
  - XXXX = no cutouts/no mounting bolts will show
  - 2XXX = rectangular fog light cutouts only
  - 2X1X = rectangular fog light and tow pin cutouts only
  - XX1X = tow pin cutouts only
  - XX10 = tag hanger bolt holes only ('HC' Peterbilt 379 only)
3. PICK YOUR END STYLE FROM PAGE 7
4. ADD ANY LIGHT OPTION CODES, IF DESIRED (SEE PAGES 89-90)
5. ADD LICENSE PLATE OPTION CODES, IF DESIRED (SEE PAGE 89)
6. APPLY 'UST' OR 'USX' SUFFIX ACCORDING TO BRACKETS SHOWN IN SECTION ABOVE

EXAMPLE: **HV-XXXX-682T-UST**

1                      2                      3                      4

**FROM THE ORIGINATORS OF THE BOLTLESS LOOK!**



HV-XXXX-682T-UST  
on a Pete 389

# BUMPER MARKER LIGHT OPTIONS

SOME POPULAR OPTIONS SHOWN  
 MIX & MATCH YOUR OWN COMBINATIONS  
 SEE PAGE 106 FOR LED LIGHT OFFERINGS

## GRANITE EXAMPLES:

KITS INCLUDE LIGHTS, BEZELS, WIRE HARNESS



-9GCA



-8GCA

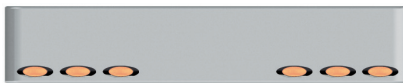

-6GCA

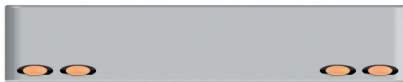

-4GCA



-9GA



-8GA

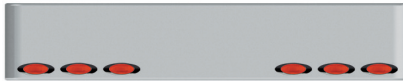

-6GA



-10GA  
 on boxed end bumper

## GRANITE MINI EXAMPLES:

KITS INCLUDE LIGHTS, BEZELS, WIRE HARNESS



-25GMCA

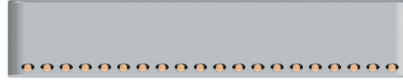

-20GMCA



-8GMCA

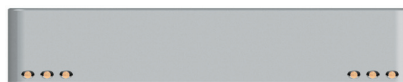

-6GMCA



-25GMA



-20GMA

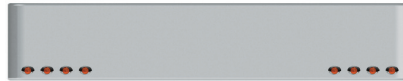

-8GMA



-6GMA

## 3/4" BULLSEYE EXAMPLES:

KITS INCLUDE LIGHTS, BEZELS, WIRE HARNESS



-74BYCA



-46BYCA



-20BYCA



-6BYCA



-74BYA



-25BYA



-15BYA



-2BYA

## 'FRENCHED' INSET LICENSE PLATE BOX:



-FL01



## STANDARD LICENSE PLATE HOLES:



-L01



-L02

## TOP TWO LICENSE PLATE HOLES:



-L2

PLACEMENT DEPENDS ON  
 BUMPER DESIGN

# BUMPER MARKER LIGHT OPTIONS

SOME POPULAR OPTIONS SHOWN  
MIX & MATCH YOUR OWN COMBINATIONS  
SEE PAGES 106 FOR LED LIGHT OFFERINGS

## OVAL LIGHT HOLE EXAMPLES:

LIGHT HOLE CUTOUTS ONLY



-009  
(-011 MAX FOR BOXED END)



-008

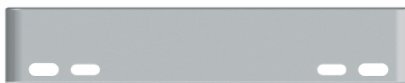

-004

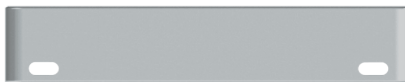

-002

## SLOTTED RECESSED OVAL EXAMPLES:

LIGHT HOLE CUTOUTS ONLY

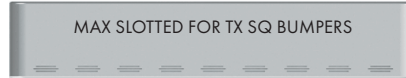

-BB9  
-BB\_ FOR SLOT HOLES ONLY, ADD YOUR OWN LIGHTS



-BB8

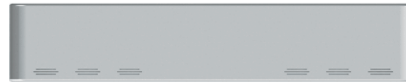

-BB6

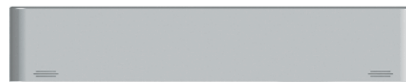

-BB2

## 2" ROUND EXAMPLES:

LIGHT HOLE CUTOUTS ONLY



-R27



-R15



-R4



-R2

## 3/4" LIGHT HOLE EXAMPLES:

LIGHT HOLE CUTOUTS ONLY



-25BYN

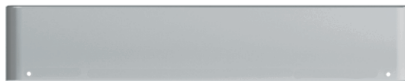

-2BYN

## SLOTTED RECESSED OVAL EXAMPLES:

INCLUDES LIGHTS, 3M TAPE, WIRE HARNESS



-9SCA  
CLEAR LENS/AMBER LEDS

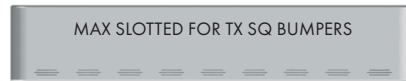

-9SA  
AMBER LENS/AMBER LEDS

## 4" ROUND EXAMPLES:

LIGHT HOLE CUTOUTS ONLY



-R13C

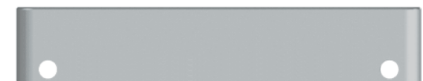

-R2C

## WATERMELON EXAMPLES:

LIGHT HOLE CUTOUTS ONLY



-W4



-B1W  
WATERMELON HOLES ON ANGLED ENDS  
45° MITRED END ROADRUNNER BUMPER

## BOXED END EXAMPLES:

LIGHT HOLE CUTOUTS ONLY

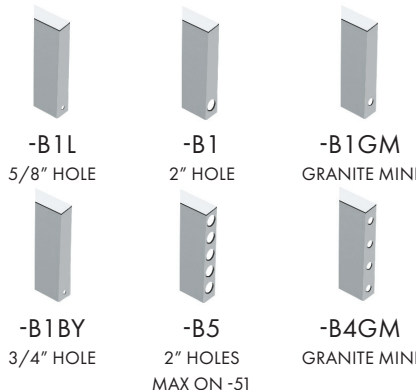

-B1L  
5/8" HOLE

-B1  
2" HOLE

-B1GM  
GRANITE MINI

-B1BY  
3/4" HOLE

-B5  
2" HOLES  
MAX ON -51

-B4GM  
GRANITE MINI

## COMBO PATTERN EXAMPLES:

LIGHT HOLE CUTOUTS ONLY



-A06-R8



-R2C-004

COMBO LIGHT NUMBERING  
PATTERN GOES FROM OUTSIDE OF  
BUMPER TO CENTER

# BUMPER LASER-CUT TEXT OPTIONS



TEXT 1



TEXT 8



TEXT 2



TEXT 9



TEXT 3



TEXT 10



TEXT 4



TEXT 11



TEXT 5



TEXT 12



TEXT 6



TEXT 13



TEXT 7

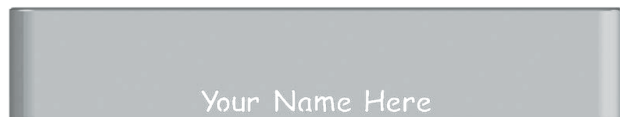

TEXT 14

## LIGHT BOXES TO MOUNT BEHIND YOUR GRAPHIC



LX-24 MOUNTED BEHIND DUPONT LOGO  
- ACTUAL NASCAR HAULER -

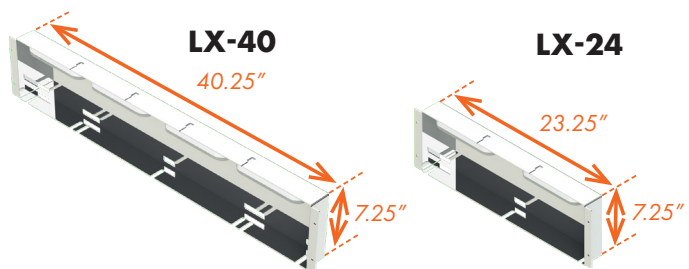

# BUMPER MOUNTING BOLT KITS

## 'UNIVERSAL' HEX BOLT SERIES

PACKAGED FOR RETAIL

POLISHED STAINLESS STEEL BOLTS

SIZE: #12 - 1.75 x 50 PARTIAL THREAD

ZINC PLATED WASHERS AND LOCKNUTS

WHITE NYLON WASHERS PROTECT CHROME SURFACE AFTER INSTALLATION



VU190082 SHOWN PACKAGED

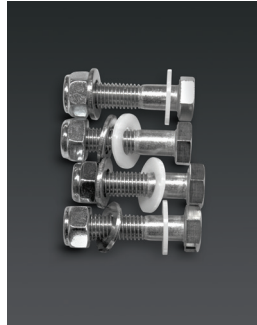

VU190080  
4 PCS KIT

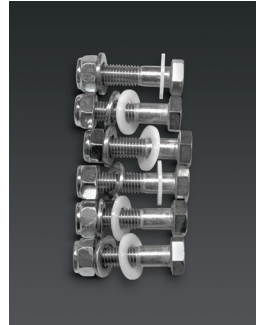

VU190081  
6 PCS KIT



VU190082  
8 PCS KIT



VU190085  
NYLON WASHERS 25-PACK

## PACCAR SERIES

PACKAGED FOR RETAIL

FITS PETERBILT 389 & KENWORTH W990 & SIMILAR CHASSIS

ZINC PLATED WASHERS AND LOCKNUTS

WHITE NYLON WASHERS PROTECT CHROME



VP190083



# NOTES

---

Lined area for notes, consisting of 25 horizontal lines.

# UNIVERSAL ACCESSORIES SECTION

LED LIGHTING AND STAINLESS PARTS  
TO FIT MOST TRUCK MAKES



QUALITY TRUCK PARTS



# WINGMASTER ACCESSORIES

## UNIVERSAL

### FLAP WEIGHTS

WEIGHTS INCLUDE MOUNTING HARDWARE  
EACH SOLD AS A PAIR



**VU190000**  
UNIVERSAL FLAP WEIGHT  
- 24" - BOTTOM - ANY MAKE  
- 11GA. STAINLESS - GIRLS



**VU190001**  
UNIVERSAL FLAP WEIGHT  
- 24" - BOTTOM - ANY MAKE  
- 11GA. STAINLESS



**VU190002**  
UNIVERSAL FLAP WEIGHT  
- 24" TOP - ANY MAKE  
- 11GA. STAINLESS



**VU190003**  
UNIVERSAL FLAP WEIGHT  
- 24" - U SHAPED BOTTOM  
- 11GA. STAINLESS



**VU190102**  
UNIVERSAL FLAP WEIGHT  
- 24" - BOTTOM - ANY MAKE  
- 11GA. STAINLESS - STEER HEAD



**VU190109**  
UNIVERSAL FLAP WEIGHT  
- 24" - U SHAPED BOTTOM  
- 11GA. STAINLESS - STEER HEAD

### TANK STRAPS



**VU190005**  
9.75" AIR TANK BANDS  
(PB. KW. FL) - PAIR



**VU190061**  
AIR TANK WRAP - FITS 9.75"  
STAINLESS AIR TANK - 1 PC  
COVER ONLY



**VU190006**  
8.25" AIR TANK BANDS  
(PB. KW. FL) - PAIR

### TAG HANGERS

EACH INCLUDE MOUNTING HARDWARE,  
FOAM PROTECTORS & TAG MOUNTING PLASTIC INSERTS

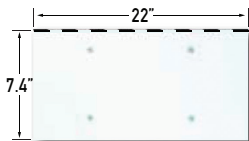

**VP120000**  
HINGED 1 TAG HANGER  
18 GA. STAINLESS  
PETE 389

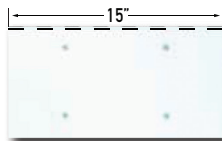

**VP120001**  
HINGED 1 TAG HANGER  
18 GA. STAINLESS  
PETE 379 & SIMILAR

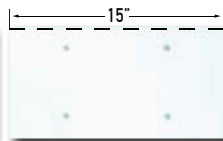

**VP120017**  
HINGED 1 TAG HANGER  
24 GA. STAINLESS  
PETE 379 & SIMILAR

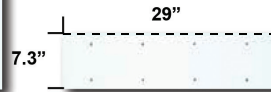

**VU190007**  
HINGED 2 TAG HANGER (PB. KW. FL)



**VU190035**  
TAG HANGER - SINGLE  
TAG - 90 DEGREE  
MOUNTS UNDER



**VU190036**  
TAG HANGER - SINGLE  
2 TAG - 90 DEGREE  
MOUNTS UNDER



**VU190037**  
TAG HANGER - SINGLE  
3 TAG - 90 DEGREE  
MOUNTS UNDER



**VU190008**  
HINGED 3 TAG HANGER (PB. KW. FL)

### TAG HANGERS WITH WATERMELONS INSTALLED



**VP120001-2WA**  
SINGLE TAG HANGER  
W/2 AMBER WATERMELONS



**VP190007-2WA**  
DUAL TAG HANGER  
W/2 AMBER WATERMELONS



**VP190008-2WA**  
TRIPLE TAG HANGER  
W/2 AMBER WATERMELONS

# WINGMASTER ACCESSORIES

## UNIVERSAL

### PERMIT PANELS

#### HINGED PANELS INCLUDES MOUNTING HARDWARE



**VU190090**  
HINGED PERMIT PANEL  
4 X 4



**VU190091**  
HINGED PERMIT PANEL  
4 X 8



**VU190092**  
HINGED PERMIT PANEL  
4 X 10



**VU190093**  
HINGED PERMIT PANEL  
4 X 12



**VU190094**  
HINGED PERMIT PANEL  
5 X 4



**VU190095**  
HINGED PERMIT PANEL  
5 X 8



**VU190096**  
HINGED PERMIT PANEL  
5 X 10



**VU190097**  
HINGED PERMIT PANEL  
5 X 12

#### FLAT PANELS INCLUDE STRONG 3M DOUBLE SIDED TAPE



**VU190098**  
FLAT PERMIT PANEL  
4 X 4 - TAPE MOUNT



**VU190099**  
FLAT PERMIT PANEL  
4 X 8 - TAPE MOUNT



**VU190103**  
FLAT PERMIT PANEL  
4 X 10 - TAPE MOUNT



**VU190104**  
FLAT PERMIT PANEL  
4 X 12 - TAPE MOUNT



**VU190105**  
FLAT PERMIT PANEL  
5 X 4 - TAPE MOUNT

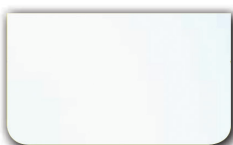

**VU190106**  
FLAT PERMIT PANEL  
5 X 8 - TAPE MOUNT

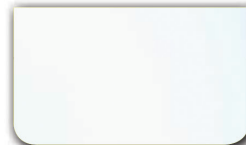

**VU190107**  
FLAT PERMIT PANEL  
5 X 10 - TAPE MOUNT

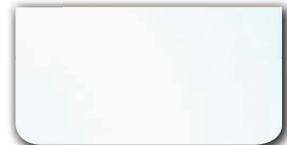

**VU190108**  
FLAT PERMIT PANEL  
5 X 12 - TAPE MOUNT

# WINGMASTER ACCESSORIES

## UNIVERSAL

### RIDGED PERMIT PANELS

90-DEGREE BEND AT TOP, NO-HINGE  
INCLUDES MOUNTING HARDWARE  
CUSTOMER DRILLS TO FIT



**VU190110**  
RIDGED PERMIT PANEL  
4 X 4



**VU190111**  
RIDGED PERMIT PANEL  
4 X 8

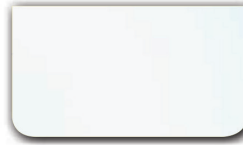

**VU190112**  
RIDGED PERMIT PANEL  
4 X 10

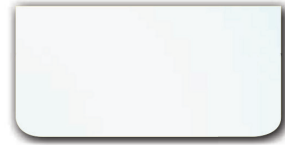

**VU190113**  
RIDGED PERMIT PANEL  
4 X 12



**VU190114**  
RIDGED PERMIT PANEL  
5 X 4

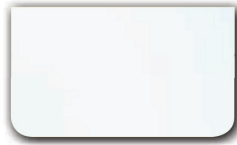

**VU190115**  
RIDGED PERMIT PANEL  
5 X 8

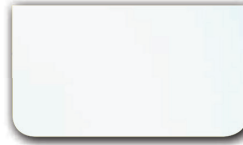

**VU190116**  
RIDGED PERMIT PANEL  
5 X 10



**VU190117**  
RIDGED PERMIT PANEL  
5 X 12

### BEACON LIGHT BRACKETS

INCLUDES MOUNTING HARDWARE



**VU190100**  
BECON LIGHT BRACKET  
8" X 8" - PR

# WINGMASTER ACCESSORIES

## UNIVERSAL AIRLINE BOXES

MOUNTING HARDWARE INCLUDED  
AIR LINE BOXES ARE 32" LONG - CLOSED BACK  
NOT AVAILABLE IN 430 STAINLESS



**VU190015**  
AIR LINE BOX - STANDARD



**VU190016R**  
AIR LINE BOX - 2-PLUG



**VU190015R**  
AIR LINE BOX - STANDARD - ROUNDED

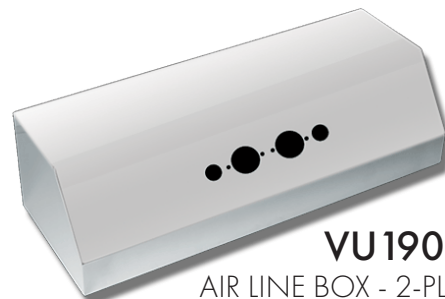

**VU190016R**  
AIR LINE BOX - 2-PLUG - ROUNDED

### TO BUILD A LIGHT BOX

1. PICK BLANK PART NUMBER
2. PICK LIGHT TYPE (REFER TO PAGE 106-107)
3. PICK THE NUMBER OF LIGHTS

**EXAMPLE: VU190016R-2CA**

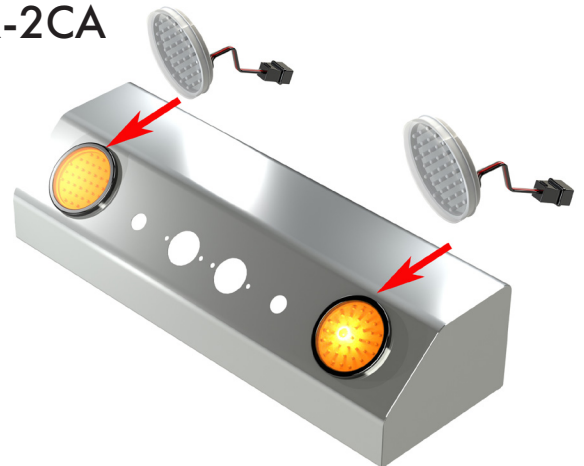
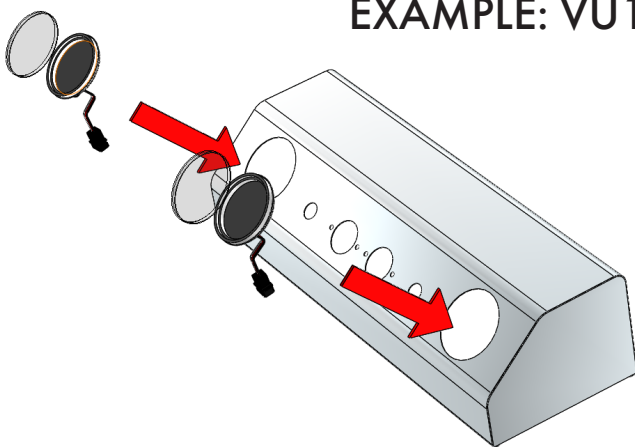

# WINGMASTER ACCESSORIES

## UNIVERSAL DECK PLATES



**VU190017**

DECK PLATE - 36" X 34" - SMOOTH STAINLESS - OVER FRAME RAILS

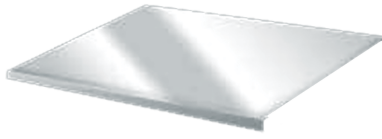

**VU190018**

DECK PLATE - 48" X 34" - SMOOTH STAINLESS - OVER FRAME RAILS

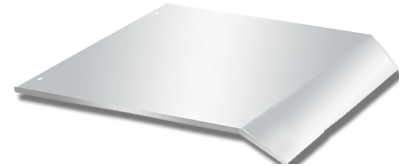

**VU190017**

REAR DECK PLATE - 29" X 33" - SMOOTH ROLLED EDGES - OVER FRAME RAILS



**VU192010**

FRONT DECK PLATE - 83" X 27" 11G, SS - BETWEEN FRAME RAILS



**VU192011**

MID DECK PLATE - 44" X 27" 11G, SS - BETWEEN FRAME RAILS



**VU192012**

REAR DECK PLATE - 48" X 27" 11G, SS - BETWEEN FRAME RAILS



**VU192022**

MID DECK PLATE - 77" X 27" 11G, SS - BETWEEN FRAME RAILS

## FRONT DECK PLATE TOOL BOX

**VU192021**

UNIVERSAL FRONT DECK PLATE TOOL BOX W/LOCK - 24" X 24"

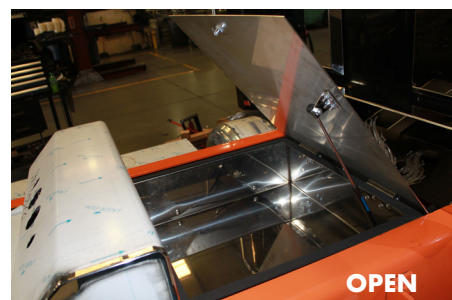
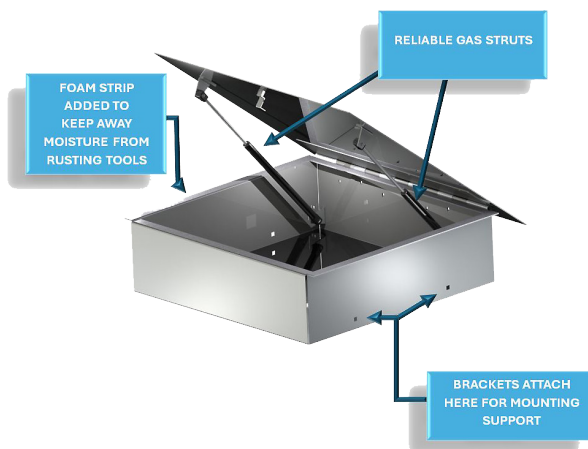

# WINGMASTER ACCESSORIES

## UNIVERSAL

### REAR FRAME TOOL BOX



VP150119

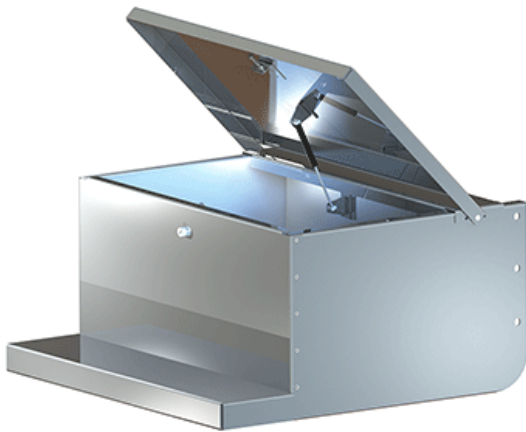

- Highly polished 304 non-directional stainless steel
- All makes fit, anywhere frame space and ground clearance is available
- Lock and keys included
- Direct raised lid with gas shock
- Brackets and hardware not included, fit to your custom location



**QUALITY TRUCK PARTS**

# WINGMASTER ACCESSORIES

## UNIVERSAL FRAME STEPS

INCLUDES SLIP RESISTANT GRIP TAPE



**VU191103**  
FRAME STEPS - 12"  
STAINLESS STEPS & SIDES

**VU191104**  
FRAME STEPS - 18"  
STAINLESS STEPS & SIDES

**VU191105**  
FRAME STEPS - 24"  
STAINLESS STEPS & SIDES



**VU191106**  
FRAME STEPS - 12"  
STAINLESS STEPS & SIDES

**VU191107**  
FRAME STEPS - 18"  
STAINLESS STEPS & SIDES

**VU191108**  
FRAME STEPS - 24"  
STAINLESS STEPS & SIDES



# WINGMASTER ACCESSORIES

## UNIVERSAL REAR WINDOW VISORS NOT AVAILABLE ON DAYCAB

INCLUDES STRONG 3M DOUBLE-SIDED TAPE AND MOUNTING HARDWARE

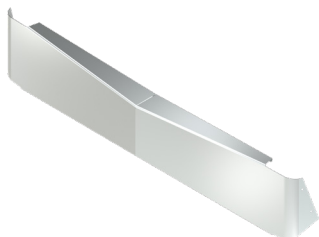

**VU193020-BT**  
REAR VISOR GANGSTER-  
BOWTIE



**VU195020**  
REAR VISOR WICKED -  
ONE-PIECE



**VU193020**  
REAR VISOR GANGSTER

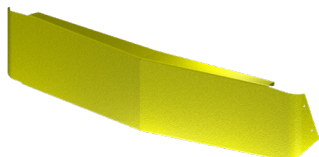

**EXAMPLE  
VU193020P**  
REAR VISOR GANGSTER

**PAINTABLE  
VISORS  
AVAILABLE**

JUST ADD "P" TO THE END  
FOR PAINTABLE  
RAW 18 GAUGE STEEL  
COLORS SHOWN EXAMPLES ONLY

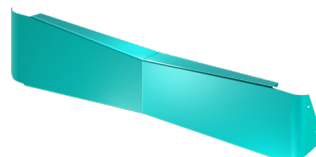

**EXAMPLE  
VU193020P-BT**  
REAR VISOR - GANGSTER  
BOWTIE

## REAR FRAME FILLERS

BOXES COME WITH VU190201 BACK COVER

18-GAUGE STAINLESS STEEL MOUNTING HARDWARE INCLUDED



**VU190203**  
REAR FRAME FILLER  
2, 4" RND LEDS & 3, GRANITE RED  
LEDS



**VU190202**  
REAR FRAME FILLER  
4, 4" RND LEDS



**VU190203**  
REAR FRAME FILLER  
4, 4" RND LEDS & 5, 2" RND

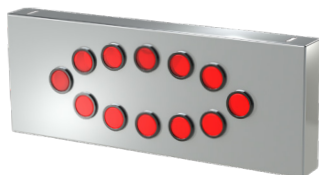

**VU190204**  
REAR FRAME FILLER  
12, 2" RND LEDS



**VU190201**  
REAR FRAME FILLER  
BACK COVER



**VU190207**  
REAR FRAME FILLER  
4, 4" RND LEDS & 5, 2" RND LEDS,  
W/STEERHEAD

**BLANK BOXES AVAILABLE  
(VU19200)**



# WINGMASTER ACCESSORIES

## UNIVERSAL

### REAR FRAME FILLERS

NOT AVAILABLE ON DAYCAB

INCLUDES STRONG 3M DOUBLE-SIDED TAPE AND MOUNTING HARDWARE



**VU190208**  
REAR FRAME FILLER - 2 - 4"  
RD / 3 - GRANITE- LEDS -  
W / STEERHEAD



**VU190209**  
REAR FRAME FILLER - 4 - 4"  
RD - LEDS - CLEAR LENS /  
EACH CORNER



**VU190210**  
REAR FRAME FILLER - 4 - 4"  
RD / 5 - 2" RD - LEDS -  
CLEAR LENS

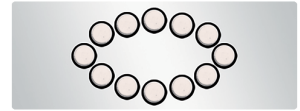

**VU190211**  
REAR FRAME FILLER - 12 - 2"  
RD - LEDS - CLEAR LENS /  
OVAL



**VU190212**  
REAR FRAME FILLER - 2 - 4"  
RD / 8 - 2" RD - LEDS -  
CLEAR LENS



**VU190213**  
REAR FRAME FILLER - 2 - 4"  
RD / 3 - GRANITE - LEDS -  
CLEAR LENS



**VU190214**  
REAR FRAME FILLER - 4 - 4"  
RD / 5 - 2" RD - LEDS - CLEAR  
LENS - W / STEERHEAD

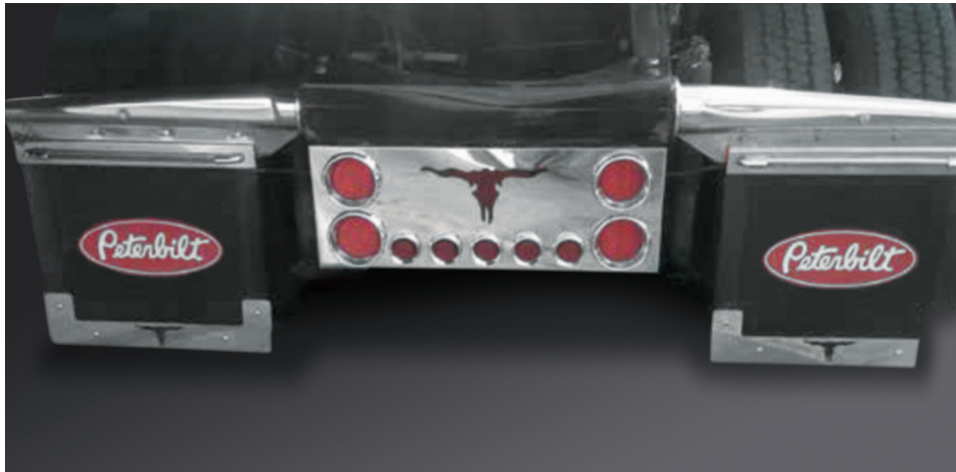

**VU190214-4CR-5RR**  
(chrome light bezels not included)

Mud flap weights VU190109 also shown

# WINGMASTER ACCESSORIES

## UNIVERSAL

### LOWER REAR FRAME FILLERS

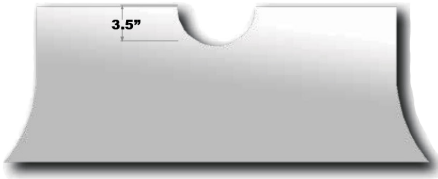

VU199002  
LOWER REAR FRAME FILLER -  
BLANK

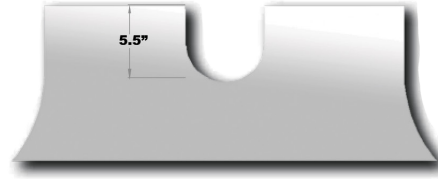

VU199005  
LOWER REAR FRAME FILLER -  
379 - BLANK

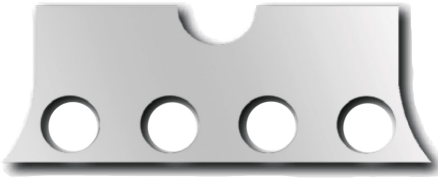

VU199002-4CN  
LOWER REAR FRAME FILLER -  
4 ROUND CUTOUTS

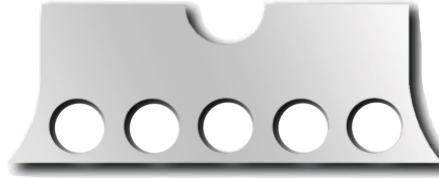

VU199002-5CN  
LOWER REAR FRAME FILLER -  
5 ROUND CUTOUTS



VU199002-5CR shown, includes lights and harness  
CHROME LIGHT BEZELS NOT INCLUDED  
WILL NOT WORK ON ALUMINUM FRAMES

# WINGMASTER ACCESSORIES

## UNIVERSAL

### RETAIL DISPLAY - LEDs

For authorized distributors



2 PACKAGES AVAILABLE:

PART# VULIGHTKIT3 FOR 12 OF EACH LIGHT AND DISPLAY BOARD

PART# VULIGHTKIT4 FOR 24 OF EACH LIGHT AND DISPLAY BOARD

Actual light display board may vary from illustration above.



# WINGMASTER ACCESSORIES

## UNIVERSAL

### LED LIGHT OPTION CHART

Use the following light chart to build your rear light bars, cab and sleeper panels, hood extension panels, and so on. Use the first letter in the name of the light and the form you wish the light to be.

Solid Accessory Part Number	Dash	Amount of Lights	Lights name - 1st letter	Lights Color	=	Complete Part Number with Lights
Vxxxxxxx	-	X	X	X	=	Vxxxxxx-XXX
VP142007	-	7	G	CA	=	VP142007-7GCA

EXAMPLE:



VP142007-7GCA

Peterbilt 379 cab panel VP142007, with seven Granite clear lens amber LED light assemblies & wire harness

### LIGHT OFFERINGS WITH LETTER AND LIGHT COLOR CODES:



#### OVAL 6"

Amber lens, Amber LEDs = O A  
 Clear lens, Amber LEDs = O CA  
 Red lens, Red LEDs = O R  
 Clear lens, Red LEDs = O CR



#### GRANITE

Amber lens, Amber LEDs = G A  
 Clear lens, Amber LEDs = G CA  
 Red lens, Red LEDs = G R  
 Clear lens, Red LEDs = G CR



#### GRANITE MINI

Amber lens, Amber LEDs = GM A  
 Clear lens, Amber LEDs = GM CA  
 Red lens, Red LEDs = GM R  
 Clear lens, Red LEDs = GM CR



#### ROUND 2"

Amber lens, Amber LEDs = R A  
 Clear lens, Amber LEDs = R CA  
 Red lens, Red LEDs = R R  
 Clear lens, Red LEDs = R CR

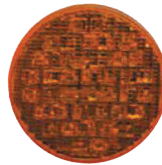

#### CORAL 4" ROUND

Amber lens, Amber LEDs = C A  
 Clear lens, Amber LEDs = C CA  
 Red lens, Red LEDs = C R  
 Clear lens, Red LEDs = C CR



#### BULLSEYE 3/4" ROUND

Amber lens, Amber LEDs = BY A  
 Clear lens, Amber LEDs = BY CA  
 Red lens, Red LEDs = BY R  
 Clear lens, Red LEDs = BY CR

# WINGMASTER ACCESSORIES

## UNIVERSAL

### BLANK LIGHT CUTOUT OPTIONS

Add your own lights to our accessories, but first get the correct cutouts:

Solid Accessory Part Number	Dash	Amount of Lights	Lights name - 1st letter	Lights Color	=	Complete Part Number with Lights
Vxxxxxxx	-	X	X	X	=	Vxxxxxxx-XXX
VP142007	-	10	BY	N	=	VP142007-10BYN

#### EXAMPLE:



VP142007-10BYN

Peterbilt 379 cab panel VP142007, with ten open 3/4" light holes

#### CUTOUT CODES:

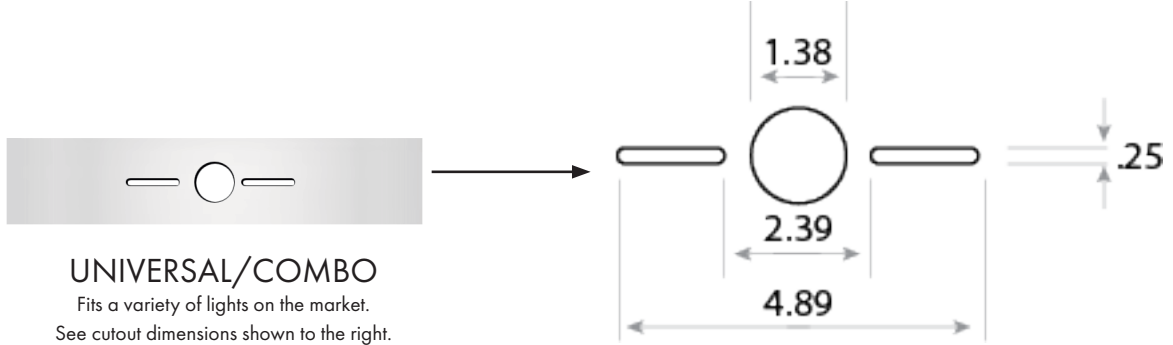

SN

OVAL SLOTTED

Mount your 6" oval light with double-sided tape behind the cutout



RN

2" ROUND



BYN

3/4" ROUND

"N" LIGHT COLOR INDICATES NO LIGHTS/OPEN CUTOUT

# WINGMASTER ACCESSORIES

## UNIVERSAL

**3-YEAR  
WARRANTY**

VU-860L  
2" Round

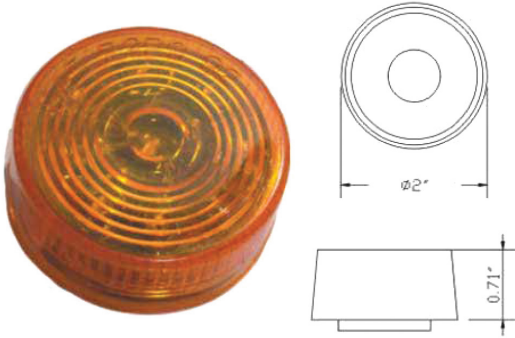

VU-860L-A shown

## LED LIGHTS

- 9 LEDs
- 12 volt
- IP67 Rated
- Sonically sealed polycarbonate lens & housing
- Epoxy encapsulated electronics and sealed wire entry prevent dirt and moisture from entering the light
- Includes a rubber grommet when ordered as a kit with bumper or accessory

Part Numbers	Lens Color	LED Color
VU-860L-A	Amber	Amber
VU-860L-CA	Clear	Amber
VU-860L-R	Red	Red
VU-860L-CR	Clear	Red

**3-YEAR  
WARRANTY**

VU-924-1L  
4" ROUND  
"CORAL"

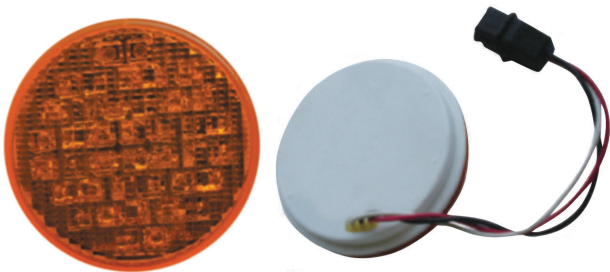

VU-924-1L-A shown

- 40 LEDs
- 12 volt or 24 volt
- IP67 Rated
- Chrome reflector for brilliant light emission
- Sonically sealed polycarbonate lens & housing
- Epoxy encapsulated electronics and sealed wire entry prevent dirt and moisture from entering the light
- Includes a rubber grommet when ordered as a kit with bumper or accessory

Part Numbers	Lens Color	LED Color
VU-924-1L-A	Amber	Amber
VU-924-1L-CA	Clear	Amber
VU-924-1L-R	Red	Red
VU-924-1L-CR	Clear	Red
VU-924-1L-CW	Clear	White

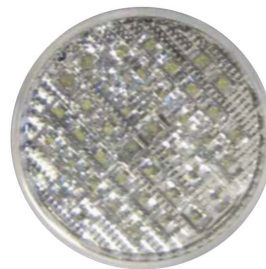
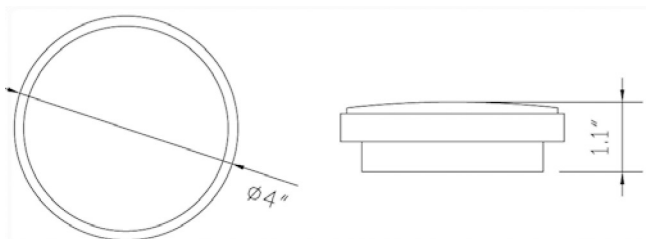

VU-924-1L-CW shown

# WINGMASTER ACCESSORIES

## UNIVERSAL

### SIGNATURE MARKER LIGHTS

**3-YEAR  
WARRANTY**



VU-1080L-A shown

VU-1080L  
GRANITE



Part Numbers	Lens Color	LED Color
VU-1080L-A	Amber	Amber
VU-1080L-CA	Clear	Amber
VU-1080L-R	Red	Red
VU-1080L-CR	Clear	Red

- 6 LEDs
- 12 volt
- Sonically sealed polycarbonate lens & housing
- Epoxy encapsulated electronics and sealed wire entry prevent dirt and moisture from entering the light
- Includes chrome bezel
- IP67 Rated



VU-7160L-A shown

VU-7160L  
GRANITE MINI

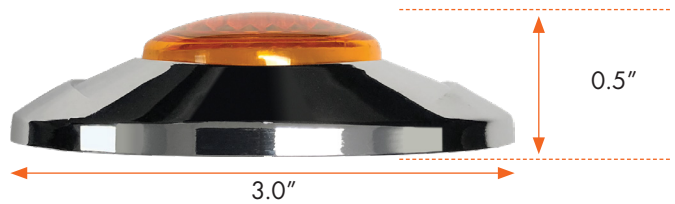

Part Numbers	Lens Color	LED Color
VU-7160L-A	Amber	Amber
VU--7160L-CA	Clear	Amber
VU--7160L-R	Red	Red
VU--7160L-CR	Clear	Red

- 3 LEDs
- 12 volt
- Sonically sealed polycarbonate lens & housing
- Epoxy encapsulated electronics and sealed wire entry prevent dirt and moisture from entering the light
- Includes chrome bezel
- IP67 Rated

**3-YEAR  
WARRANTY**

# WINGMASTER ACCESSORIES

## UNIVERSAL

### SIGNATURE MARKER LIGHTS

**3-YEAR WARRANTY**



VU-1094L  
GRANITE SLIM



Part Numbers	Lens Color	LED Color
VU-1094L-A	Amber	Amber
VU-1094L-CA	Clear	Amber
VU-1094L-R	Red	Red
VU-1094L-CR	Clear	Red

- 3 LEDs
- 12 volt
- Sonically sealed polycarbonate lens & housing
- Epoxy encapsulated electronics and sealed wire entry prevent dirt and moisture from entering the light
- Includes chrome bezel
- IP67 rated

## GRANITE COLLECTION COUNTERTOP DISPLAYS AVAILABLE

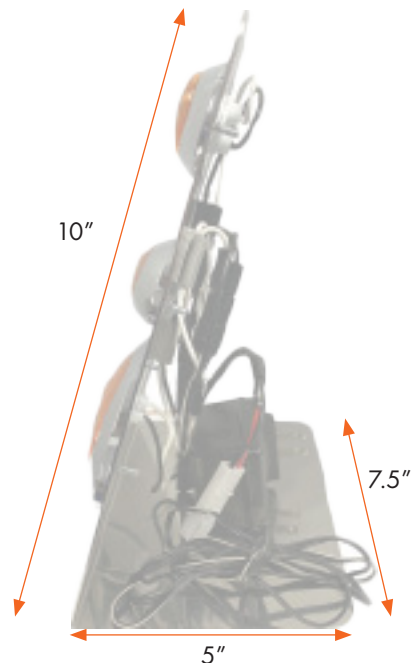

VU-LDG3-BK FOR BLACK POWDER COATED DISPLAY

VU-LDG3-SS FOR POLISHED STAINLESS STEEL DISPLAY



# WINGMASTER ACCESSORIES

## UNIVERSAL

**3-YEAR  
WARRANTY**

### LED LIGHTS

VU-998-1L

3/4" ROUND  
"BULLSEYE"



VU-998-1L-CA shown

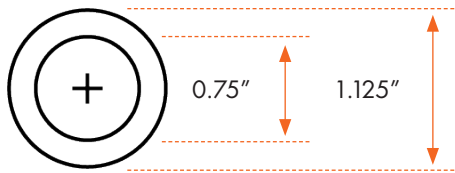

- 3 LEDs
- 12 volt
- Sonically sealed polycarbonate lens & housing
- Epoxy encapsulated electronics and sealed wire entry prevent dirt and moisture from entering the light
- Includes chrome bezel
- IP67 Rated

Part Numbers	Lens Color	LED Color
VU-998-1L-A	Amber	Amber
VU-998-1L-CA	Clear	Amber
VU-998-1L-R	Red	Red
VU-998-1L-CR	Clear	Red

**3-YEAR  
WARRANTY**

VU-968-1L

6" OVAL



VU-968-1L-R shown



(rear view)

- 21 Super LEDs
- 12 volt
- Chrome reflector for brilliant light emission
- Sonically sealed polycarbonate lens & housing
- Epoxy encapsulated electronics and sealed wire entry prevent dirt and moisture from entering the light
- Includes an ABS plastic snap-ring and rubber grommet when ordered as a kit with bumper or accessory
- IP67 Rated

Part Numbers	Lens Color	LED Color
VU-968-1L-A	Amber	Amber
VU-968-1L-CA	Clear	Amber
VU-968-1L-R	Red	Red
VU-968-1L-CR	Clear	Red
VU-968-1L-CW	Clear	White



VU-968-1L-A shown  
with ABS snap ring



VU-968-1L-CW shown



# WINGMASTER ACCESSORIES

## UNIVERSAL

### LED LIGHTS

**3-YEAR  
WARRANTY**

#### VU-949-1L

#### "TORPEDO" CAB MARKER



VU-949-1L-A shown

- 19 LEDs
- 12 volt
- Chrome reflector for brilliant light emission
- Bright chrome outer housing
- Rubber mounting pad
- Sonically sealed polycarbonate lens & housing
- Epoxy encapsulated electronics and sealed wire entry prevent dirt and moisture from entering the light
- Includes chrome bezel
- IP67 Rated

Part Numbers	Lens Color	LED Color
VU-949-1L-A	Amber	Amber
VU-949-1L-CA	Clear	Amber

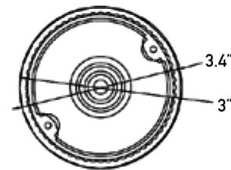
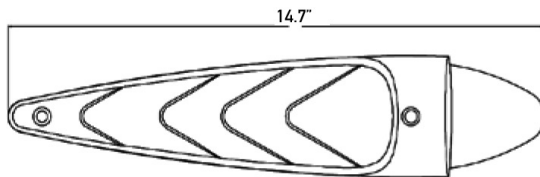

#### VU-855L

#### VINTAGE CAB MARKER



VU-855L-A shown

- 36 LEDs
- 12 volt
- Bright chrome outer housing
- Sonically sealed polycarbonate lens & housing
- Epoxy encapsulated electronics and sealed wire entry prevent dirt and moisture from entering the light
- Includes chrome bezel
- IP67 Rated

**3-YEAR  
WARRANTY**

Part Numbers	Lens Color	LED Color
VU-855L-A	Amber	Amber
VU-855L-CA	Clear	Amber

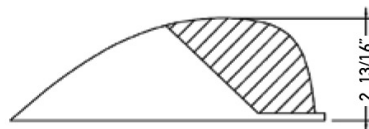
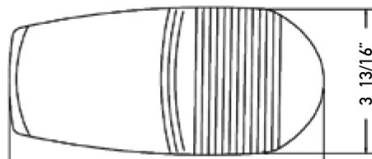

# WINGMASTER ACCESSORIES

## UNIVERSAL

**3-YEAR  
WARRANTY**

### PETE TURN/PARK/CLEARANCE LIGHT

VU-951L

6" x 5" CLEARANCE

- 31 Super LEDs
- IP67 Rated
- 12 volt
- Sonically sealed polycarbonate lens & housing
- Epoxy encapsulated electronics and sealed wire entry prevent dirt and moisture from entering the light

Part Numbers	Lens Color	LED Color
VU-951L-A	Amber	Amber
VU-951L-CA	Clear	Amber



VU-951L-A shown

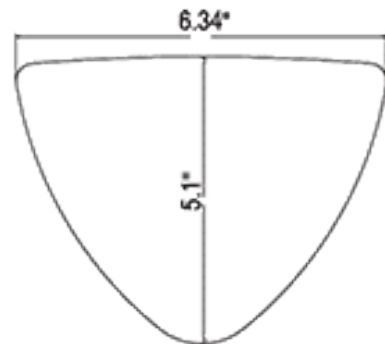
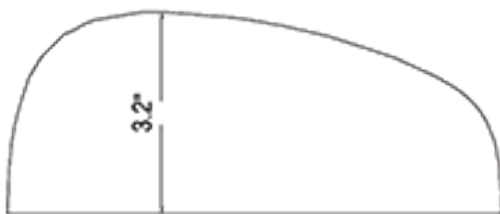

# WINGMASTER ACCESSORIES

**UNIVERSAL**

**LED LIGHTS**

**3-YEAR  
WARRANTY**



**QUALITY TRUCK PARTS**

# WINGMASTER ACCESSORIES

## UNIVERSAL WIRE HARNESSSES

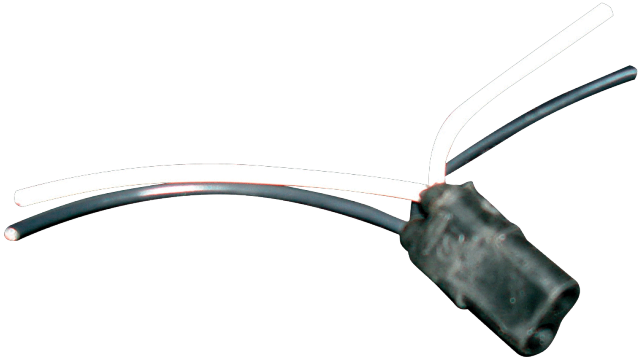

VU-877F

FEMALE HARNESS

- 2 female bullets
- 100 ft. length
- Available in 4", 6", 8" or 10" spacing – see part numbers

Part Numbers	Bullet spacing
VU-877F-4	4"
VU-877F-6	6"
VU-877F-8	8"
VU-877F-10	10"

VHMS3007

AIR CLEANER LIGHT BOX HARNESS



- See pages 126, 134, 166 for air cleaner light boxes
- One PACCAR female end
- Two PACCAR male ends



**QUALITY TRUCK PARTS**

# WINGMASTER ACCESSORIES

## PETERBILT MODEL 359



Bumpers and Stainless Accessories made in the USA



[www.valleychrome.com](http://www.valleychrome.com)

# WINGMASTER ACCESSORIES

## PETERBILT MODEL 359

### CAB PANEL 3.5"

#### MOUNTING HARDWARE INCLUDED



**VP110235**  
PB CAB PANELS - 359 -  
STANDARD BLANK - PAIR



**VP110238**  
PB CAB PANEL, EXT. PANEL  
FORMED 359 2PC. STANDARD  
WRAP BLANK - PAIR



**VP110236**  
PB CAB PANELS - 359 -  
STANDARD WRAP BLANK - PAIR



ADD LIGHTS TO YOUR PANEL – SEE PAGES 106-107

### HOOD EXTENSIONS



**VP110319**  
PB - 359 HOOD EXTENSION  
PANEL - FACTORY



# WINGMASTER ACCESSORIES

## PETERBILT MODEL 359

### MISC. TRIM PIECES



VP110023

PB 359 TOP OF DOOR TRIM - LOWERED LOOK - 359

CUSTOM HEIGHTS AVAILABLE



VP110023-P FOR PAINTABLE



VP110027

PB 359 WINDSHIELD WIPER ARM COVERS



VP120113

PB BUG SHIELD - STAINLESS  
- 359

MOUNTING HARDWARE INCLUDED



VP120504

PB 359 FENDER SUPPORT  
COVER - FRONT - BLANK

RUBBER TRIM AND MOUNTING  
HARDWARE INCLUDED





# WINGMASTER ACCESSORIES

## PETERBILT MODEL 359

### STANDARD MOUNT STAINLESS VISORS



VP130001

PB - 359 12" DROP VISOR - ANY YEAR 359

**PAINTABLE  
VISORS  
AVAILABLE**

JUST ADD "P" TO THE END  
FOR PAINTABLE. EXAMPLE:

VP130001-P

RAW 18 GAUGE STEEL

ADD LIGHTS TO YOUR VISOR – SEE PAGES 106-107

FOR MORE PETE VISORS SEE PAGES 198-201

### GANGSTER STAINLESS VISORS



VP132001

PB - 12" GANGSTER VISOR - 359 2 PC



VP132001-BT

PB - 12" GANGSTER BOWTIE VISOR - 359 2 PC



VP132001-BF

PB - 12" GANGSTER BUTTERFLY VISOR - 359 2 PC



VP132001-RBF

PB - 12" GANGSTER VISOR - 359 2 PC, REVERSE BUTTERFLY

VP132001P-RBF

PB - 12" GANGSTER VISOR - 359 - PAINTABLE 2 PC, REVERSE BUTTERFLY

### WICKED VISORS



VP135001

PB - 12" WICKED - DROP VISOR -  
ANY YEAR 359 - 2 PC

### VISOR FOR 350 SERIES, YEARS 1970 & OLDER



VP130016

PB - 9" STANDARD VISOR  
350 SERIES YEARS 1970 & OLDER

# WINGMASTER ACCESSORIES

## PETERBILT MODEL 359

### AIR DEFLECTORS



VP110016  
PB 359 - 379, 389 WINDOW  
AIR DEFLECTORS



VP110031  
PB 359 - 379, 389 WINDOW  
AIR DEFLECTORS W/LOWER  
LOOKS( VP110017 )WINDOW  
TRIM 37.25" X 20.375"

### FUEL TANK STRAP COVERS

#### BRACKETS & MOUNTING HARDWARE INCLUDED



VP150039  
PB 359 - FUEL TANK STRAP  
COVERS - 2PCS



# WINGMASTER ACCESSORIES

---

## PETERBILT MODEL 359

### MISC. TRIM PIECES

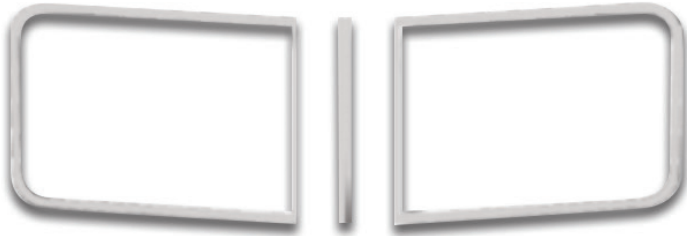

VP110024  
PB WINDSHIELD TRIM - 3 PC 359 -  
STANDARD - 430 STAINLESS



VP110012  
359, 379 DOOR FLAME  
TRIM - PAIR



# WINGMASTER ACCESSORIES

## PETERBILT MODELS 365 & 367



Bumpers and Stainless Accessories made in the USA



[www.valleychrome.com](http://www.valleychrome.com)

# WINGMASTER ACCESSORIES

## PETERBILT MODEL 365 & 367

### CAB PANELS 4"

#### MOUNTING HARDWARE INCLUDED



VP110241

PB CAB PANELS - 2005 &  
NEWER - 367, 365 - BLANK  
WRAP - SET BACK ONLY

#### ADD LIGHT OPTIONS TO A PART NUMBER

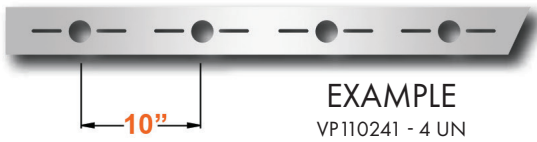

EXAMPLE  
VP110241 - 4 UN



EXAMPLE  
VP110241 - 5 RN



EXAMPLE  
VP110241 - 4 RA

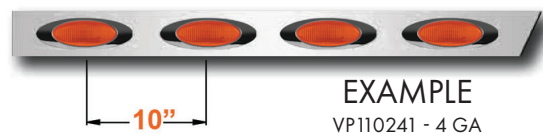

EXAMPLE  
VP110241 - 4 GA

ADD LIGHTS TO YOUR PANEL – SEE PAGES 106-107



# WINGMASTER ACCESSORIES

## PETERBILT MODEL 365 & 367

### SLEEPER PANELS 4"

MOUNTING HARDWARE INCLUDED  
MATCH TO SLEEPER EXTENSION PANELS ON NEXT PAGE



**VP142064**  
PB SLEEPER PANELS - 367,  
365 - 36"/44" - BLANK



**VP142065**  
PB SLEEPER PANELS - 367,  
365 - 48"/58" - BLANK



**VP142066**  
PB SLEEPER PANELS - 367,  
365 - 63"/72" - BLANK



**VP142067**  
PB SLEEPER PANELS - 367,  
365 - 70"/78" - BLANK

### ADD LIGHT OPTIONS:



**EXAMPLE**  
VP142065 - 5 UN



**EXAMPLE**  
VP142065 - 5 RN



**EXAMPLE**  
VP142067 - 8 RA

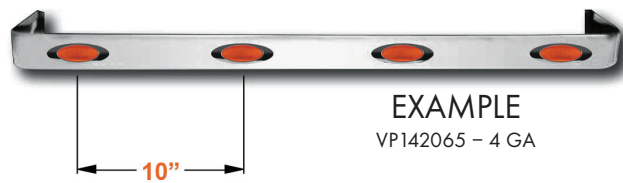

**EXAMPLE**  
VP142065 - 4 GA

ADD LIGHTS TO YOUR PANEL – SEE PAGES 106-107

Peterbilt Truck Models	Original Sleeper Length Designation	New Sleeper Length Designation
365, 367, 379, 384, 386, 388, 389	36"	44"
	48"	58"
	63"	72"
	70"	78"



# WINGMASTER ACCESSORIES

## PETERBILT MODEL 365 & 367

### SLEEPER EXTENSION PANELS 4"

MOUNTING HARDWARE INCLUDED

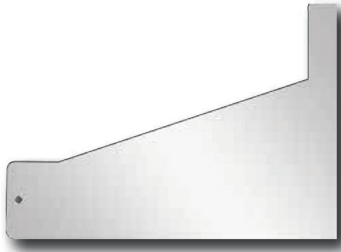

**VP142101**

PB SLEEPER EXTENSION  
PANEL - 1987 & NEWER - 384,  
379, 388, 389 - 63"/72" - BLANK,  
365, 367

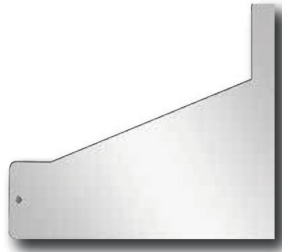

**VP142103**

PB SLEEPER EXTENSION  
PANEL - 1987 & NEWER - 384,  
379, 388, 389 - 70"/78" - BLANK,  
365, 367



### ADD LIGHT OPTIONS:

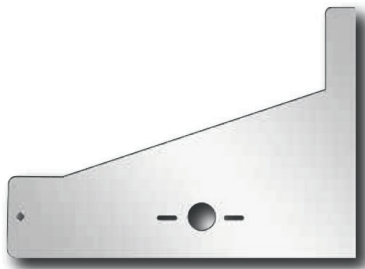

**EXAMPLE**

VP142101-1UN

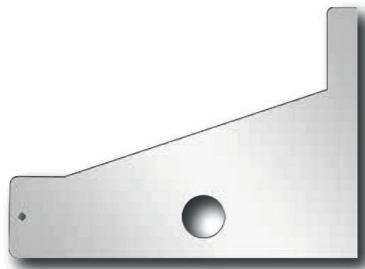

**EXAMPLE**

VP142101-1RN



**EXAMPLE**

VP142101-1GA

ADD LIGHTS TO YOUR PANEL – SEE PAGES 106-107

Peterbilt Truck Models	Original Sleeper Length Designation	New Sleeper Length Designation
365, 367, 379, 384, 386, 388, 389	36"	44"
	48"	58"
	63"	72"
	70"	78"

# WINGMASTER ACCESSORIES

## PETERBILT MODEL 365 & 367

### AIR CLEANER LIGHT BOXES

CONNECTS TO AIR CLEANER STRAP



VP112118

PB - AIR CLEANER LIGHTS - BLANK -  
367, 365 - 2005 & NEWER - SET BACK  
AXLE ONLY - PAIR

CUSTOM  
EXAMPLE:

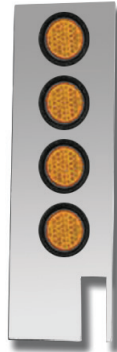

VP112118-4RA

PB - AIR CLEANER LIGHTS - 4 ROUND  
AMBERS - 367, 365 - 2005 & NEWER - SET  
BACK AXLE ONLY - PAIR

Don't Forget the  
Light Harness:



VHMS3007

1 - PACCAR - FEMALE 2 - PACCAR - MALE  
- FOR CONNECTING FRONT & REAR AIR  
CLEANER LIGHTS

ADD LIGHTS TO YOUR PANEL – SEE PAGES 106-107

### BUG SHIELDS



VP120110

PB BUG SHIELD - STAINLESS - 367, 388, 389

MOUNTING HARDWARE INCLUDED



QUALITY TRUCK PARTS



# WINGMASTER ACCESSORIES

## PETERBILT MODELS 379 & 389



- 1 VP132002P** Gangster visor, 12", paintable
- 2 VP110018** Windshield trim kit -large
- 3 VP120502** Front blinker bars (pair) with LEDs  
Similar: VP120501 for model 379
- 4 VP110228** Cab panels –extended wrap  
Shown with four slotted light holes (VP110228-4S)
- 5 VP110308** Hood extension panel – wide replacement  
Shown with three slotted light holes (VP110308-3S)
- 6 VP150011R** Fuel tank fairings (pair), rounded style, 64" long
- 7 VP142000** 4" sleeper panels (pair) for 63"/72" sleeper  
Shown with five slotted light holes (VP142000-5S),  
6" wide also available
- 8 VP150109R** Rear tool box with locks, smooth stainless, rounded look
- 9 911** Turbowing for flat top / cabover
- 10 HV-XXXX-58-6BB-L01-UST** Front chrome bumper, boltless,  
22" American Eagle, 6 slotted light hole  
Multiple other stock & custom bumpers available



**SEE PAGES 155-177  
FOR MODEL 389  
ACCESSORIES**

Bumpers and Stainless Accessories made in the USA



[www.valleychrome.com](http://www.valleychrome.com)

# WINGMASTER ACCESSORIES

## PETERBILT MODEL 379



**FOR 379 VISORS SEE PAGES 198-201**



# WINGMASTER ACCESSORIES

## PETERBILT MODEL 379

### ONE-PIECE CAB/HOOD EXTENSION PANELS

MOUNTING HARDWARE INCLUDED

#### VP116401

PB CAB & WIDE REPLACEMENT  
PANEL - ONE PIECE - 379 -  
4" - BLANK



#### VP116402

PB CAB & WIDE REPLACEMENT  
PANEL - ONE PIECE - WRAP - 379 -  
4" - BLANK

#### VP116201

PB CAB & WIDE REPLACEMENT  
PANEL - ONE PIECE - 379 - 6" -  
BLANK



#### VP116202

PB CAB & WIDE REPLACEMENT  
PANEL - ONE PIECE - WRAP - 379  
- 6" - BLANK

ADD LIGHTS TO YOUR PANEL – SEE PAGES 106-107



# WINGMASTER ACCESSORIES

## PETERBILT MODEL 379



### CAB PANELS 4"

#### MOUNTING HARDWARE INCLUDED

##### VP110203

PB CAB PANELS - 1987 &  
NEWER - 379, 388, 389 -  
STANDARD - BLANK - PAIR

##### VP110207

PB CAB PANELS - 1987 &  
NEWER - 379, 388, 389 -  
EXTENDED - BLANK - PAIR

##### VP110227

PB CAB PANELS - 1987 &  
NEWER - 379, 388, 389 -  
STANDARD WRAP - BLANK - PAIR

##### VP110228

PB CAB PANELS - 1987 &  
NEWER - 379, 388, 389 -  
EXTENDED WRAP - BLANK - PAIR

ADD LIGHTS TO YOUR PANEL – SEE PAGES 106-107

### CAB PANELS 6"

#### MOUNTING HARDWARE INCLUDED

##### VP110250

PB CAB PANELS - 1987 &  
NEWER - 379, 388, 389 -  
STANDARD - BLANK - PAIR

##### VP110251

PB CAB PANELS - 1987 &  
NEWER - 379, 388, 389 -  
EXTENDED - BLANK - PAIR

##### VP110254

PB CAB PANELS - 1987 &  
NEWER - 379, 388, 389 -  
EXTENDED WRAP - BLANK - PAIR

##### VP110253

PB CAB PANELS - 1987 &  
NEWER - 379, 388, 389 -  
STANDARD WRAP - BLANK - PAIR

#### ADD LIGHT OPTIONS:

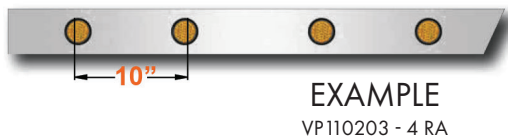
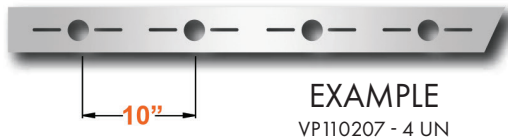

# WINGMASTER ACCESSORIES

## PETERBILT MODEL 379

### HOOD EXTENSION PANELS 4"

MOUNTING HARDWARE INCLUDED (excl. VP110310)



**VP110300**  
PB 379 - HOOD EXTENSION  
PANEL - FACTORY  
REPLACEMENT



**VP110310**  
PB 379 - HOOD EXTENSION  
PANEL - FACTORY  
LAYOVER  
TAPE MOUNT



**VP110301**  
PB 379 - HOOD EXTENSION  
PANEL - WIDE REPLACEMENT  
- BLANK - PAIR

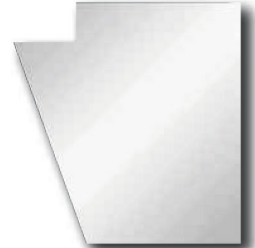

**VP110303**  
PB 379 - HOOD EXTENSION  
PANEL - WIDE REPLACEMENT  
NOTCHED - BLANK - PAIR

ADD LIGHTS TO YOUR PANEL – SEE PAGES 106-107

### HOOD EXTENSION PANELS 6"

MOUNTING HARDWARE INCLUDED



**VP110350**  
PB 379 - HOOD EXTENSION  
PANEL - FACTORY  
REPLACEMENT



**VP110352**  
PB 379 - HOOD EXTENSION  
PANEL - WIDE REPLACEMENT  
- BLANK - PAIR

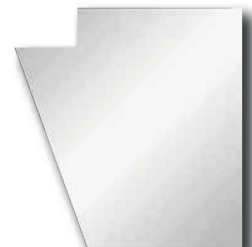

**VP110358**  
PB 379 - HOOD EXTENSION  
PANEL - WIDE REPLACEMENT  
NOTCHED - BLANK - PAIR

ALL NOTCHED HOOD EXTENSION PANELS TAKE A STANDARD CAB PANEL  
ALL WIDE HOOD EXTENSION PANELS TAKE AN EXTENDED CAB PANEL

# WINGMASTER ACCESSORIES

## PETERBILT MODEL 379

### SLEEPER PANELS 4"

MOUNTING HARDWARE INCLUDED  
MATCH TO SLEEPER EXTENSION PANELS ON NEXT PAGE



**VP142004**

PB SLEEPER PANELS - 1987 &  
NEWER - 379, 388, 389 - 36"/44"  
- BLANK - PAIR



**VP142007**

PB SLEEPER PANELS - 1987 &  
NEWER - 379, 388, 389 - 48"/58"  
- BLANK - PAIR



**VP142000**

PB SLEEPER PANELS - 1987 &  
NEWER - 379, 388, 389 - 63"/72"  
- BLANK - PAIR



**VP142002**

PB SLEEPER PANELS - 1987 &  
NEWER - 379, 388, 389 - 70"/78"  
- BLANK - PAIR

### ADD LIGHT OPTIONS



EXAMPLE  
VP142002 - 8 RA

8"



EXAMPLE  
VP142007 - 4 GA

10"

ADD LIGHTS TO YOUR PANEL - SEE PAGES 106-107

### SLEEPER PANELS 6"

MOUNTING HARDWARE INCLUDED  
MATCH TO SLEEPER EXTENSION PANELS ON NEXT PAGE



**VP142050**

PB SLEEPER PANELS - 1987 &  
NEWER - 379, 388, 389 - 36"/44"  
- BLANK - PAIR



**VP142051**

PB SLEEPER PANELS - 1987 &  
NEWER - 379, 388, 389 - 48"  
- BLANK - PAIR



**VP142052**

PB SLEEPER PANELS - 1987 &  
NEWER - 379, 388, 389 - 63"/72"  
- BLANK - PAIR



**VP142053**

PB SLEEPER PANELS - 1987 &  
NEWER - 379, 388, 389 - 70"/80"  
- BLANK - PAIR

Peterbilt Truck Models	Original Sleeper Length Designation	New Sleeper Length Designation
365, 367, 379, 384, 386, 388, 389	36"	44"
	48"	58"
	63"	72"
	70"	78"

# WINGMASTER ACCESSORIES

## PETERBILT MODEL 379

### SLEEPER EXTENSION PANELS 4"

MOUNTING HARDWARE INCLUDED

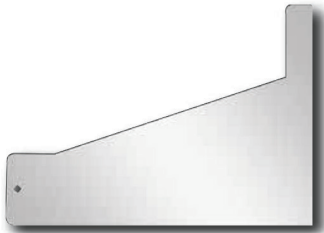

**VP142101**  
PB SLEEPER EXTENSION  
PANEL - 1987 & NEWER - 379,  
388, 389 - 63"/72" - BLANK

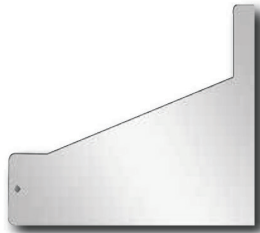

**VP142103**  
PB SLEEPER EXTENSION  
PANEL - 1987 & NEWER - 379,  
388, 389 - 70"/78" - BLANK



ADD LIGHTS TO YOUR PANEL – SEE PAGES 106-107

### SLEEPER EXTENSION PANELS 6"

MOUNTING HARDWARE INCLUDED

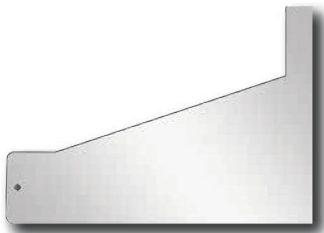

**VP142150**  
PB SLEEPER EXTENSION  
PANEL - 1987 & NEWER - 379,  
388, 389 - 63"/72" - BLANK

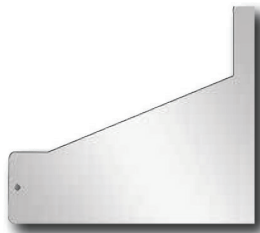

**VP142151**  
PB SLEEPER EXTENSION  
PANEL - 1987 & NEWER - 379,  
388, 389 - 70"/78" - BLANK



Peterbilt Truck Models	Original Sleeper Length Designation	New Sleeper Length Designation
365, 367, 379, 384, 386, 388, 389	36"	44"
	48"	58"
	63"	72"
	70"	78"

# WINGMASTER ACCESSORIES

## PETERBILT MODEL 379

### AIR CLEANER LIGHT BOXES VORTEX

CONNECT TO AIR CLEANER STRAPS:



**VP110109**  
PB - AIR CLEANER  
LIGHTS - BLANK - 377, 378,  
379 - 1987 & NEWER - PAIR -  
VORTEX - FRONT

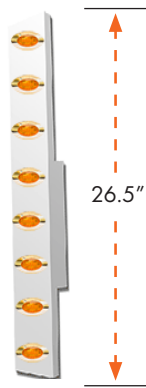

**VP113108**  
PB - AIR CLEANER  
LIGHTS - REAR -  
BLANK - 377, 378, 379 -  
1987 & NEWER - PAIR -  
VORTEX - REAR

FOR STRAPLESS LOOK:



**VP112209**  
PB - AIR CLEANER SUPPORT - BLANK -  
379, 388, 389 - 2007 & NEWER - PAIR

ADD LIGHTS TO YOUR PANEL – SEE PAGES 106-107

EXAMPLE



**VP110109-8RA**  
PB - AIR CLEANER LIGHTS - 8 ROUND  
AMBERS - 377, 378, 379 - 1987 & NEWER -  
PAIR - VORTEX



*Don't Forget the  
Light Harness:*



**VHMS3007**  
1 - PACCAR - FEMALE 2 - PACCAR - MALE  
- FOR CONNECTING FRONT & REAR AIR  
CLEANER LIGHTS



# WINGMASTER ACCESSORIES

## PETERBILT MODEL 379

### MIRROR LIGHT BOXES



**VP114011**  
MIRROR LIGHT BOXES - 379,  
388, 389 - CAB MOUNTED  
MIRRORS - BLANK



ADD -SM WITH BUILT IN SPOT MIRRORS

ADD LIGHTS TO YOUR PANEL – SEE PAGES 106-107

#### EXAMPLES:



**VP114011-2GA**  
MIRROR LIGHT BOXES - 379,  
388, 389 - CAB MOUNTED  
MIRRORS - 2 - GRANITE -  
AMBER LEDS



**VP114011-5RCA**  
MIRROR LIGHT BOXES - 379,  
388, 389 - CAB MOUNTED  
MIRRORS - 5 - 2" ROUNDS -  
CLEAR AMBER LEDS



**VP114011-2SCA**  
MIRROR LIGHT BOXES - 379,  
388, 389 - CAB MOUNTED  
MIRRORS - 2 - SLOTTED -  
CLEAR AMBER LEDS



**VP114011-5RA**  
MIRROR LIGHT BOXES - 379,  
388, 389 - CAB MOUNTED  
MIRRORS - 5 - 2" ROUNDS -  
AMBER LEDS

# WINGMASTER ACCESSORIES

## PETERBILT MODEL 379

### BUMPER & GRILLE TRIM

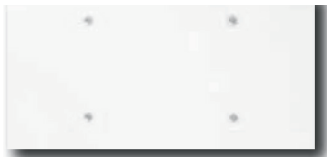

**VP120001**  
PB 1 TAG HANGER  
INCLUDES HARDWARE, FOAM  
PROTECTORS AND PLASTIC  
LICENSE PLATE BOLT INSERTS



**VP120004**  
PB TOW PIN COVER - 378, 379 -  
1987 & NEWER  
MOUNTING HARDWARE  
INCLUDED

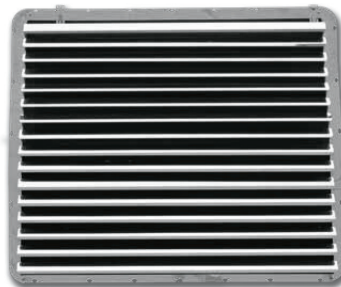

**VP120201**  
PB 379 LONG NOSE GRILL -  
HORIZONTAL - RIVETED  
MOUNTING HARDWARE  
INCLUDED



**VP120012**  
PB SIDE GRILL  
DEFLECTOR  
379, 388, 389

SEE PAGE 95 FOR MORE TAG HANGERS

### FENDER GUARDS



**VP120005**  
PB FENDER GUARDS - FITTED  
- 379 - 1987 & NEWER - 2PC



**VP120006**  
PB FENDER GUARDS -  
ROLLED, BOLT - THROUGH -  
379 - 1987 & NEWER - 2PC

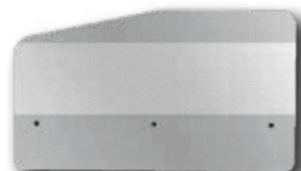

**VP120007**  
PB FENDER GUARDS - PLAIN -  
378, 379 - 1987 & NEWER



**VP120009**  
PB FENDER GUARDS -  
PLAIN - 378, 379 - 1987 &  
NEWER W/JJ CUTOUT

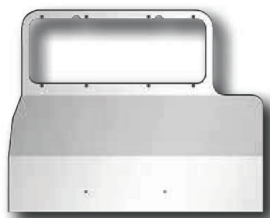

**VP120010**  
PB FENDER GUARDS - PB -  
DOUBLE HEAD LIGHT MOUNT - 378, 379  
- 1987 & NEWER - 2PC



**VP120011**  
PB FENDER GUARDS - SINGLE  
HEAD LIGHT MOUNT -  
378, 379 - 1987 & NEWER

# WINGMASTER ACCESSORIES

## PETERBILT MODEL 379

### BUG SHIELDS

#### MOUNTING HARDWARE INCLUDED



VP120103  
PB BUG SHIELD TRIM ONLY  
(HIGHLIGHT) - 379 ONLY  
STAINLESS STEEL



VP120105  
PB BUG SHIELD TRIM ONLY  
(FLAMES) - 379 ONLY  
STAINLESS STEEL



VP120106  
PB BUG SHIELD - STAINLESS -  
379 - LONG HOOD



VP120107  
PB BUG SHIELD - STAINLESS  
- 357, 378, 385, 379 -  
SHORT HOOD



# WINGMASTER ACCESSORIES

## PETERBILT MODEL 379

### BLINKER BARS

RUBBER TRIM AND MOUNTING HARDWARE INCLUDED



#### VP120501

PB 379 FRONT BLINKER BARS  
- W/ LEDS - PAIR

NOTE: ALREADY HAS SLOTTED LIGHT  
HOLES AND LIGHTS, NO  
NEED TO BUILD CUSTOM

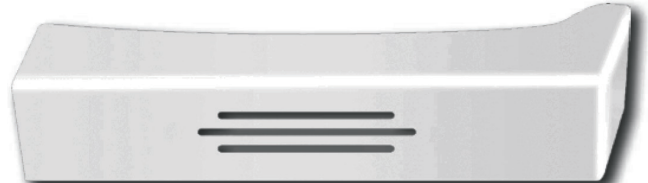

#### VP100501

PB 379 REAR BLINKER BARS -  
- W/ LEDS - PAIR

NOTE: ALREADY HAS SLOTTED LIGHT  
HOLES AND LIGHTS, NO  
NEED TO BUILD CUSTOM



#### VP120501 BL

PB 379 FRONT BLINKER BARS  
- W/ LEDS - PAIR

NO LIGHT HOLES  
ADD LIGHTS TO YOURS,  
SEE PAGES 106 -107

### FENDER SUPPORT COVERS

RUBBER TRIM AND MOUNTING HARDWARE INCLUDED



#### VP120505

PB 379 FENDER SUPPORT  
COVER - FRONT - BLANK

# WINGMASTER ACCESSORIES

## PETERBILT MODEL 379

### SLEEPER FILLER PANELS

#### MOUNTING HARDWARE INCLUDED



**VP140021**  
PB SLEEPER REAR CORNER  
FILLER PANELS 70" ONLY -  
379, 389 - 4 - 4" LEDS - PAIR

### SLEEPER SHOCK COVERS

#### RUBBER STRIP & HARDWARE INCLUDED



**VP140034**  
PB SLEEPER SHOCK COVERS  
- 379, 389 - 2 PCS (L+R)  
ANGLED  
TAPE MOUNT



**VP140022**  
PB 379, 389 SLEEPER SHOCK  
COVERS - 2 PAIR  
TAPE MOUNT

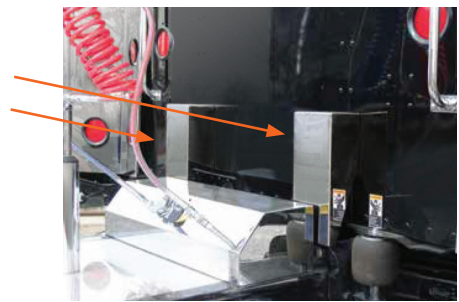

**VP140032**  
PB SLEEPER SHOCK COVERS  
- 379,389 - 1 LG FULL COVER  
TAPE MOUNT

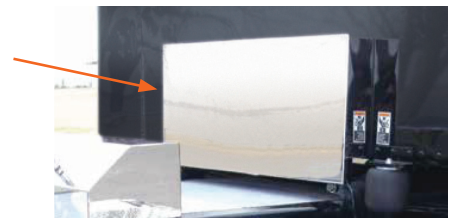

**VP140035**  
PB SLEEPER SHOCK COVER -  
379,389 ANGLED FULL COVER

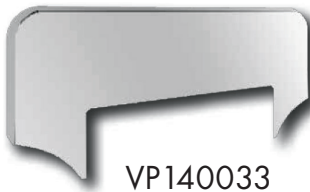

**VP140033**  
PB SLEEPER SHOCK COVERS  
- 379,389 - 1 LG CURVED FULL COVER

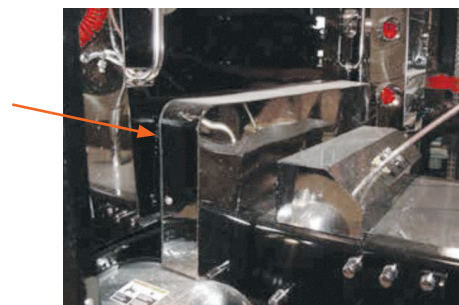

RUBBER STRIP & HARDWARE INCLUDED

# WINGMASTER ACCESSORIES

## PETERBILT MODEL 379

### AIR DEFLECTORS

#### VP110016

PB 359 - 379, 389 WINDOW AIR  
DEFLECTORS  
TAPE MOUNT



#### VP110031

PB 359 - 379, 389 WINDOW  
AIR DEFLECTORS W/LOWER  
LOOKS( VP110017 )WINDOW  
TRIM 37.25" X 20.375"  
TAPE MOUNT



### FUEL TANK STRAP COVERS

BRACKETS & MOUNTING HARDWARE INCLUDED



#### VP150020

PB - FUEL TANK STRAP  
COVERS - 4PCS



#### VP150029

PB - FUEL TANK STRAP  
COVERS - 2PCS  
NOT 359

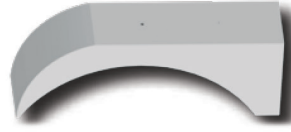

#### VP150029R

PB - FUEL TANK STRAP  
COVERS - ROUND - 2PCS  
ALL BUT 359



QUALITY TRUCK PARTS

# WINGMASTER ACCESSORIES

## PETERBILT MODEL 379

### FUEL TANK FAIRINGS

BRACKETS & HARDWARE INCLUDED  
NOT AVAILABLE 430 STAINLESS



60"

VP150010

PB - FUEL TANK FAIRINGS 60"  
379 - 1987 & NEWER - PAIR



64"

VP150011

PB - FUEL TANK FAIRINGS 64"  
379 - 1987 & NEWER - PAIR

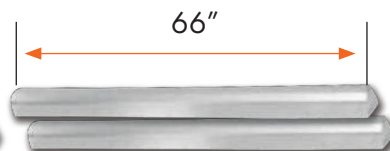

66"

VP150012

PB - FUEL TANK FAIRINGS 66"  
379 - 1987 & NEWER - PAIR

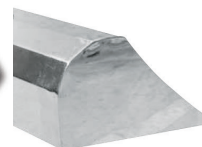

STANDARD



VP150010R

PB - FUEL TANK FAIRINGS  
60" 379 - 1987 & NEWER - PAIR  
ROUND



VP150011R

PB - FUEL TANK FAIRINGS  
64" 379 - 1987 & NEWER - PAIR  
ROUND



VP150012R

PB - FUEL TANK FAIRINGS  
66" 379 - 1987 & NEWER - PAIR  
ROUND



ROUNDED



VP150010W

PB - FUEL TANK FAIRINGS  
60" 379 - 1987 & NEWER - PAIR -  
WING LOOK



VP150011W

PB - FUEL TANK FAIRINGS  
64" 379 - 1987 & NEWER - PAIR -  
WING LOOK



VP150012W

PB - FUEL TANK FAIRINGS  
66" 379 - 1987 & NEWER - PAIR -  
WING LOOK

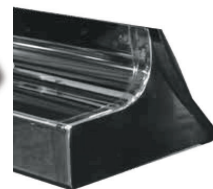

WING LOOK

ADD LIGHTS TO YOUR PANEL - SEE PAGES 106-107



EXAMPLE:

VP150012-5GA

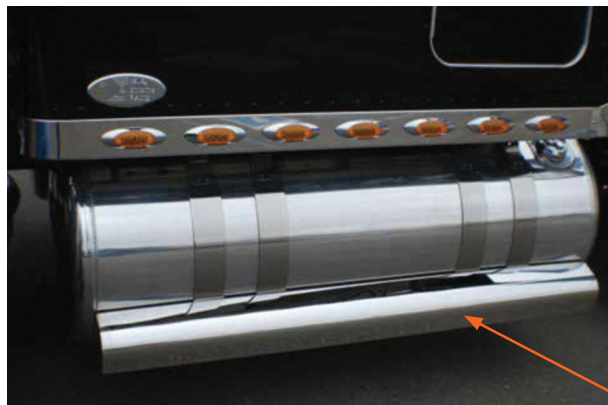

# WINGMASTER ACCESSORIES

## PETERBILT MODEL 379

### EMBLEMS



VP100009  
EMBLEM ACCENT PB 379  
RACING STRIPE - 2PC



VP100028  
EMBLEM ACCENT PB 379 -  
RACING STRIPE - LONG - PAIR

### MISC. TRIM PIECES



VP100021  
PB 379 FENDER TRIM  
INNER WELL - 2PC

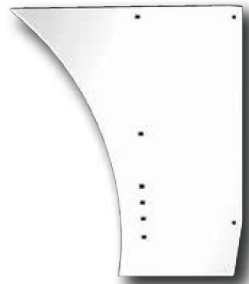

VP100020  
PB LOWER HOOD PANEL  
EXTENDED HOOD - 379 1987  
& NEWER - 2PC



VP100025  
PB 379 CENTER HOOD TRIM  
EXTENDED HOOD



VP100026  
PB 379 FENDER TRIM - 2PC



VP110012  
359, 379 DOOR FLAME  
TRIM - PAIR



VP110018  
PB WINDSHIELD TRIM - 5 PC  
379, 389 - LARGE



VP110015  
PB CENTER EXT WINDSHIELD  
TRIM - 377, 378, 379



# WINGMASTER ACCESSORIES

## PETERBILT MODEL 379

### MISC TRIM PIECES



**VP110022**

PB 379 TOP OF DOOR TRIM - LOWERED LOOK - 73-04 - DOOR  
MOUNTED MIRRORS - PR  
TAPE MOUNT

CUSTOM HEIGHTS AVAILABLE



VP110022P FOR PAINTABLE



**VPTFI8021**

PB OUTER FENDER  
TRIM - 379  
INCLUDES SET SCREWS  
SOLD AS SET OF 3 PAIR

**VPTFI8021 S**  
FOR ONE PAIR



**VP110025**

PB 379, 388, 389 WINDSHIELD WIPER  
ARM COVERS  
TAPE MOUNT

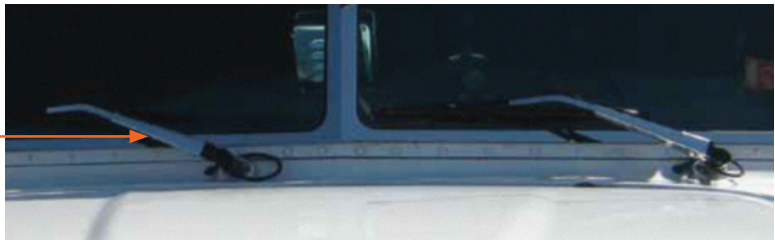

# WINGMASTER ACCESSORIES

## PETERBILT MODEL 379

### BATTERY BOXES & TOOL BOXES

STANDARD WIDTH 30" / CUSTOM WIDTHS AVAILABLE UP TO 48"

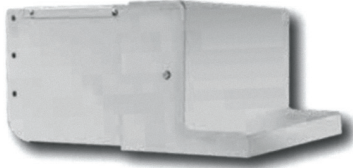

VP150112 - PB - 379,388, 389 REAR TOOL BOX - STAINLESS W/LOCKS - ROUNDED MOULDED LID

VP150113 - PB - 379, 388, 389 BATTERY BOX - STAINLESS W/LOCKS - ROUNDED MOULDED LID

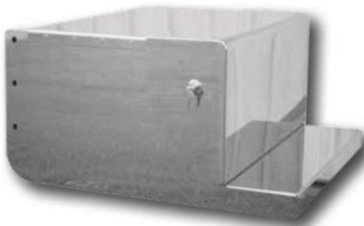

VP150109R - PB - 379, 388, 389 REAR TOOL BOX - STAINLESS W/LOCKS - ROUNDED SMOOTH LOOK

VP150110R - PB - 379, 388, 389 BATTERY BOX - STAINLESS W/LOCKS - ROUNDED SMOOTH LOOK

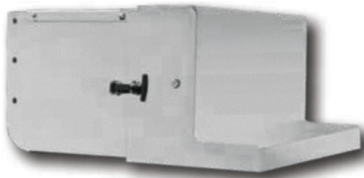

VP150115 - PB - 379,388, 389 REAR TOOL BOX - STAINLESS W/LOCKS - MOULDED LID

VP150116 - PB - 379, 388, 389 BATTERY BOX - STAINLESS W/LOCKS - MOULDED LID

VP150116TM - PB - 379, 388, 389 BATT, BOX - STAINLESS W/TIE DOWNS - 18" TALL MOULDED LID

ADD -36 TO ANY STAINLESS TOOL BOX PART NUMBER FOR A 36" BOX  
ADD -48 TO ANY STAINLESS TOOL BOX PART NUMBER FOR A 48" BOX

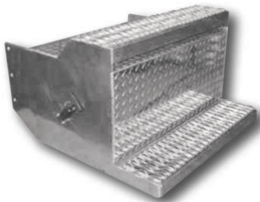

VP150103

PB - 379, 388, 389 BATTERY BOX - ALUMINUM



VP150104

PB - 379, 388, 389 BATTERY BOX - ALUMINUM



### BOX STEP HIGHLIGHTS/PROTECTORS



VP150030

PB TOOL BOX/BATTERY BOX - STEP PROTECTOR-(18") - WICKED PR

VP150031

PB TOOL BOX/BATTERY BOX - STEP PROTECTOR- (30") WICKED PAIR

PAINTED OPTIONS SHOWN

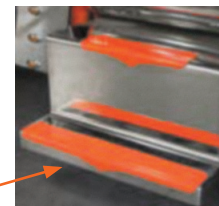

# WINGMASTER ACCESSORIES

## PETERBILT MODEL 379 TOOL & BATTERY BOX COVERS

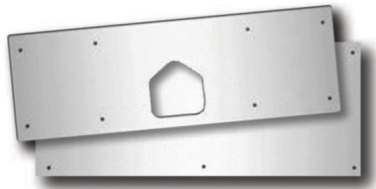

**VP150002**  
PB TOOL & BATTERY BOX  
COVER 1993 & NEWER - 2 PC.



**VP150003**  
PB BATTERY BOX COVER 378,  
379 - 12" X 30" - 1993 & NEWER



**VP150004**  
PB TOOL BOX COVER 378, 379  
- 10" X 30" - 1993 & NEWER



**VP150015**  
PB TOOL BOX COVER -  
W/ 1" LIP ON TOP - 378, 379



**VP150016**  
PB 379 BATTERY BOX COVER -  
W/ 1" LIP ON TOP

## PETERBILT MODEL 379 TAG & LICENSE PLATE HANGERS

ALSO FITS MODEL 389

**VP120021**  
PB WIDE TAG/LIC PLATE HANGER  
INCLUDES HARDWARE, FOAM PROTECTORS & PLASTIC LICENSE PLATE  
BOLT INSERTS

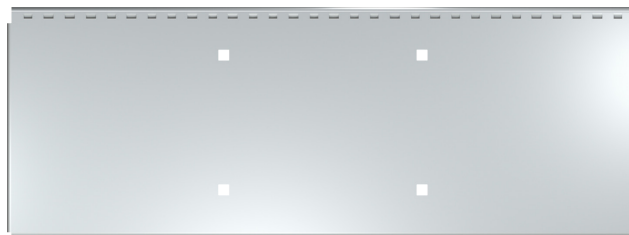
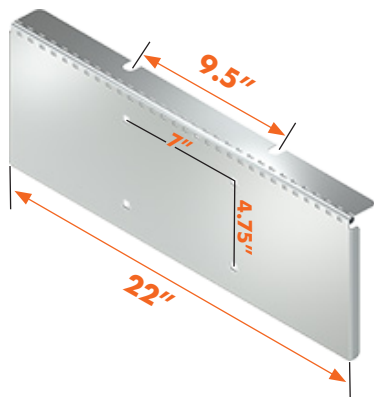

AVAILABLE WITH 2 WATERMELON  
LIGHTS INSTALLED  
(VP120021-2WA SHOWN)

# WINGMASTER ACCESSORIES

## PETERBILT MODEL 384



Bumpers and Stainless Accessories made in the USA



[www.valleychrome.com](http://www.valleychrome.com)

# WINGMASTER ACCESSORIES

## PETERBILT MODEL 384

### CAB PANELS 4"

#### MOUNTING HARDWARE INCLUDED



VP110338

PB CAB PANELS - 384 - STANDARD -  
BLANK - WRAP PAIR

ADD LIGHTS TO YOUR PANEL – SEE PAGES 106-107

### CAB PANELS 6"

#### MOUNTING HARDWARE INCLUDED



VP110252

PB CAB PANELS - 384 -  
STANDARD - BLANK - PAIR



VP110353

PB CAB PANELS - 384 - STANDARD -  
BLANK - WRAP - PAIR

#### ADD LIGHT OPTIONS:

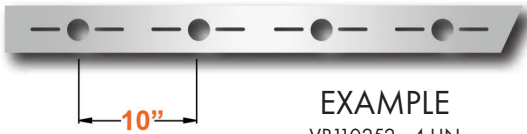

EXAMPLE  
VP110252 - 4 UN



EXAMPLE  
VP110252 - 5 RN



EXAMPLE  
VP110252 - 4 RA



EXAMPLE  
VP110252 - 3 GA

# WINGMASTER ACCESSORIES

## PETERBILT MODEL 384

### SLEEPER PANELS 4"

MOUNTING HARDWARE INCLUDED  
MATCH TO SLEEPER EXTENSION PANELS ON NEXT PAGE



**VP142060**  
PB SLEEPER PANELS - 384  
- 36"/44" - NOTCHED FOR  
EXHAUST - BLANK



**VP142061**  
PB SLEEPER PANELS - 384 -  
48"/58" - NOTCHED FOR EXHAUST  
- BLANK



**VP142062**  
PB SLEEPER PANELS - 384  
- 63"/72" - NOTCHED FOR  
EXHAUST - BLANK



**VP142063**  
PB SLEEPER PANELS - 384  
- 70"/78" - NOTCHED FOR  
EXHAUST - BLANK

ADD LIGHTS TO YOUR PANEL – SEE PAGES 106-107

### SLEEPER PANELS 6"

MOUNTING HARDWARE INCLUDED  
MATCH TO SLEEPER EXTENSION PANELS ON NEXT PAGE



**VP142160**  
PB SLEEPER PANELS - 384  
- 36"/44" - NOTCHED FOR  
EXHAUST - BLANK



**VP142161**  
PB SLEEPER PANELS - 384 -  
48"/58" - NOTCHED FOR EXHAUST  
- BLANK



**VP142162**  
PB SLEEPER PANELS - 384  
- 63"/72" - NOTCHED FOR  
EXHAUST - BLANK



**VP142163**  
PB SLEEPER PANELS - 384  
- 70"/78" - NOTCHED FOR  
EXHAUST - BLANK

### ADD LIGHT OPTIONS



EXAMPLE  
VP142063 – 8 RA

8"



EXAMPLE  
VP142060 – 4 GA

10"

Peterbilt Truck Models	Original Sleeper Length Designation	New Sleeper Length Designation
365, 367, 379, 384, 386, 388, 389	36"	44"
	48"	58"
	63"	72"
	70"	78"

# WINGMASTER ACCESSORIES

## PETERBILT MODEL 384

### SLEEPER EXTENSION PANELS 4"

MOUNTING HARDWARE INCLUDED

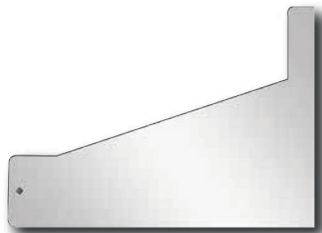

**VP142101**  
PB SLEEPER EXTENSION  
PANEL - 1987 & NEWER - 379,  
388, 389 - 63"/72" - BLANK

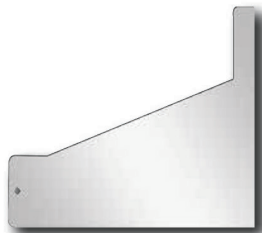

**VP142103**  
PB SLEEPER EXTENSION  
PANEL - 1987 & NEWER - 379,  
388, 389 - 70"/78" - BLANK



ADD LIGHTS TO YOUR PANEL – SEE PAGES 106-107

### SLEEPER EXTENSION PANELS 6"

MOUNTING HARDWARE INCLUDED

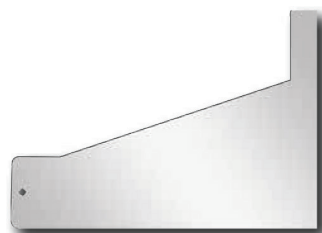

**VP142150**  
PB SLEEPER EXTENSION  
PANEL - 1987 & NEWER - 379,  
388, 389 - 63"/72" - BLANK

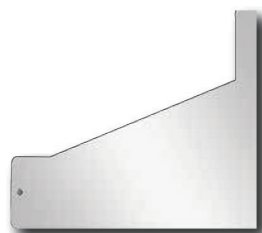

**VP142151**  
PB SLEEPER EXTENSION  
PANEL - 1987 & NEWER - 379,  
388, 389 - 70"/78" - BLANK



Peterbilt Truck Models	Original Sleeper Length Designation	New Sleeper Length Designation
365, 367, 379, 384, 386, 388, 389	36"	44"
	48"	58"
	63"	72"
	70"	78"

### BUG SHIELDS



**VP120111**  
PB BUG SHIELD - STAINLESS - 384  
MOUNTING HARDWARE INCLUDED

# WINGMASTER ACCESSORIES

## PETERBILT MODEL 386



Bumpers and Stainless Accessories made in the USA



[www.valleychrome.com](http://www.valleychrome.com)



# WINGMASTER ACCESSORIES

## PETERBILT MODEL 386

### CAB PANELS 2.5"

MOUNTING HARDWARE INCLUDED



VP110200  
PB CAB PANELS - 2005 &  
NEWER - 386 - BLANK

ADD LIGHTS TO YOUR PANEL – SEE PAGES 106-107

### EXHAUST FILLER PANEL 2.5"

MOUNTING HARDWARE INCLUDED



VP110205  
PB EX HAUST FILLER PANEL -  
386 - BLANK - PAIR

#### ADD LIGHT OPTIONS:



10" EXAMPLE  
VP110205 - 3 GA



13" EXAMPLE  
VP110205 - 3 PA



10" EXAMPLE  
VP110205 - 3 UN

386 PANELS ARE ONLY 2.5" WIDE AND CAN ONLY USE  
GRANITE, PETERBILT AND UNIVERSAL CUT OUTS.

# WINGMASTER ACCESSORIES

## PETERBILT MODEL 386

### SLEEPER PANELS 2.5"

MOUNTING HARDWARE INCLUDED  
MATCH TO SLEEPER EXTENSION PANELS ON NEXT PAGE



**VP142008**  
PB SLEEPER PANELS - 1987 &  
NEWER - 386 - 36"/44" -  
BLANK - PR



**VP142009**  
PB SLEEPER PANELS - 1987 &  
NEWER - 386 - 48"/58" -  
BLANK - PR



**VP142010**  
PB SLEEPER PANELS - 1987 &  
NEWER - 386 - 63"/72" -  
BLANK - PR



**VP142011**  
PB SLEEPER PANELS - 1987 &  
NEWER - 386 - 70"/78" -  
BLANK - PR

ADD LIGHTS TO YOUR PANEL – SEE PAGES 106-107

### ADD LIGHT OPTIONS

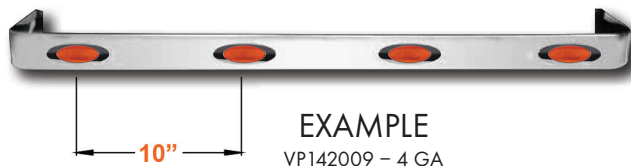

386 PANELS ARE ONLY 2.5" WIDE AND CAN ONLY USE  
GRANITE, PETERBILT AND UNIVERSAL CUT OUTS.

Peterbilt Truck Models	Original Sleeper Length Designation	New Sleeper Length Designation
365, 367, 379, 384, 386, 388, 389	36"	44"
	48"	58"
	63"	72"
	70"	78"

# WINGMASTER ACCESSORIES

## PETERBILT MODEL 386

### SLEEPER EXTENSION PANELS 2.5"

#### MOUNTING HARDWARE INCLUDED

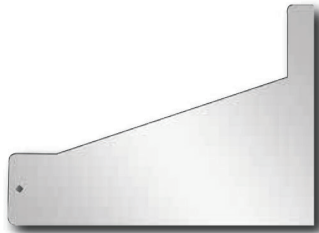

**VP142111**  
PB SLEEPER EXTENSION  
PANEL - 1987 & NEWER - 386 -  
2.5" WIDE - 70"/78" - BLANK

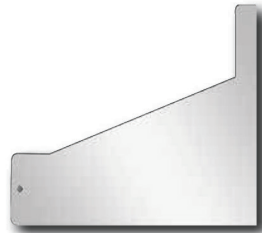

**VP142112**  
PB SLEEPER EXTENSION PANEL  
- 1987 & NEWER - 386 - 2.5" WIDE -  
36,48,63"/72" - BLANK



ADD LIGHTS TO YOUR PANEL – SEE PAGES 106-107

#### ADD LIGHT OPTIONS

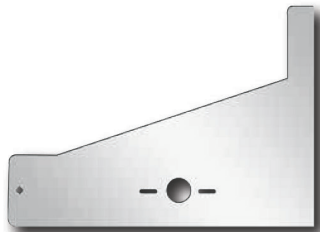

EXAMPLE  
VP142112-1UN



EXAMPLE  
VP142112-1GA



EXAMPLE  
VP142112-1PA

386 PANELS ARE ONLY 2.5" WIDE AND CAN ONLY USE  
GRANITE, PETERBILT AND UNIVERSAL CUT OUTS.

Peterbilt Truck Models	Original Sleeper Length Designation	New Sleeper Length Designation
365, 367, 379, 384, 386, 388, 389	36"	44"
	48"	58"
	63"	72"
	70"	78"

#### BUG SHIELDS



**VP120112**  
PB BUG SHIELD - STAINLESS - 384/386  
MOUNTING HARDWARE INCLUDED

# WINGMASTER ACCESSORIES

## PETERBILT MODELS 388 & 389



FOR 388 & 389 VISORS SEE PAGES 198-201

Bumpers and Stainless Accessories made in the USA



[www.valleychrome.com](http://www.valleychrome.com)

# WINGMASTER ACCESSORIES

## PETERBILT MODEL 388 & 389

### FORMED CAB PANELS 4"

MOUNTING HARDWARE INCLUDED

4" WIDE DRIVER SIDE, ALSO AVAILABLE IN 6" WIDTH  
2.25" ONLY ON PASSENGER SIDE



**VP114207**  
PB CAB PANELS - 1987 &  
NEWER - 388, 389 - FORMED  
EXTENDED - BLANK - PR



**VP114228**  
PB CAB PANELS - 1987 &  
NEWER - 388, 389 - FORMED  
EXTENDED WRAP- BLANK - PR



**VP114267**  
PB CAB PANELS - 389 - 2010 &  
NEWER - FORMED EXTENDED  
- W / UREA SYSTEM - 2.1/4"  
PASSANGER SIDE - 4" DRIVERS  
SIDE - BLANK

ADD LIGHTS TO YOUR PANEL – SEE PAGES 106-107

### FORMED CAB PANELS 6"



**VP114251**  
PB CAB PANELS - 1987 &  
NEWER - 388, 389 - FORMED  
EXTENDED - BLANK - PR



**VP114253**  
PB CAB PANELS - 1987 &  
NEWER - 388, 389 - FORMED  
EXTENDED WRAP- BLANK - PR

ADD LIGHT OPTIONS:



EXAMPLE  
VP114251-3GA



# WINGMASTER ACCESSORIES

## PETERBILT MODEL 388 & 389

### ONE-PIECE CAB/HOOD EXTENSION PANELS, NO DEF SYSTEM

#### MOUNTING HARDWARE INCLUDED

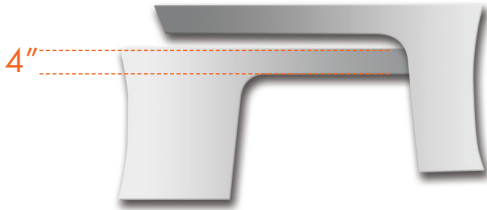

#### VP116400

PB CAB & WIDE REPLACEMENT  
PANEL - ONE PIECE - 389  
2009-2011 - NON UREA - WIDE  
REPLACEMENT DRIVERS  
SIDE - SMALL REPLACEMENT  
PASSENGERS SIDE - 4" CAB  
PANELS - BLANK

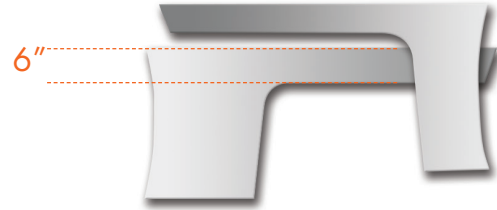

#### VP116200

PB CAB & WIDE  
REPLACEMENT PANEL - ONE  
PIECE - 389 2009-2011 - NON  
UREA - WIDE REPLACEMENT  
DRIVERS SIDE - SMALL  
REPLACEMENT PASSENGERS  
SIDE - 6" CAB PANELS - BLANK

#### VP116411

PB CAB & WIDE REPLACEMENT  
PANEL - ONE PIECE - 389  
2009-2011 - NON UREA - WIDE  
REPLACEMENT DRIVERS  
SIDE - SMALL REPLACEMENT  
PASSENGERS SIDE - 4" CAB  
PANELS - WRAP - BLANK

#### VP116211

PB CAB & WIDE REPLACEMENT  
PANEL - ONE PIECE - 389  
2009-2011 - NON UREA - WIDE  
REPLACEMENT DRIVERS  
SIDE - SMALL REPLACEMENT  
PASSENGERS SIDE - 6" CAB  
PANELS - WRAP - BLANK

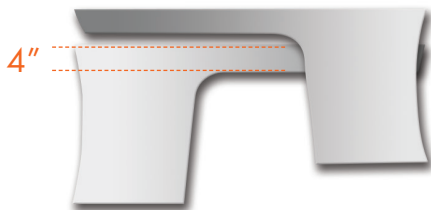

#### VP116420

PB CAB & WIDE REPLACEMENT PANEL BOTH  
SIDES - ONE PIECE - 389 2008 -  
NON UREA - 4" CAB PANELS - BLANK

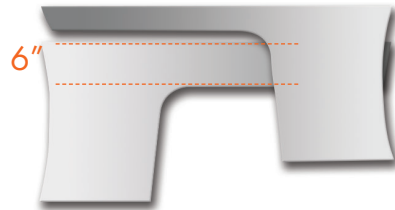

#### VP116420-6

PB CAB & WIDE REPLACEMENT PANEL  
BOTH SIDES - ONE PIECE - 389 2008 -  
NON UREA - 6" CAB PANELS - BLANK

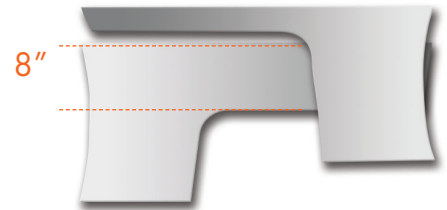

#### VP116420-8

PB CAB & WIDE REPLACEMENT PANEL  
BOTH SIDES - ONE PIECE - 389 2008 -  
NON UREA - 8" CAB PANELS - BLANK

**2008-2010 WITH CAT ENGINES USE WIDE PANELS BOTH SIDES  
2009-2010 CUMMINS ENGINES USE WIDE DRIVER SIDE, NARROW PASSENGER**

ADD LIGHTS TO YOUR PANEL – SEE PAGES 106-107

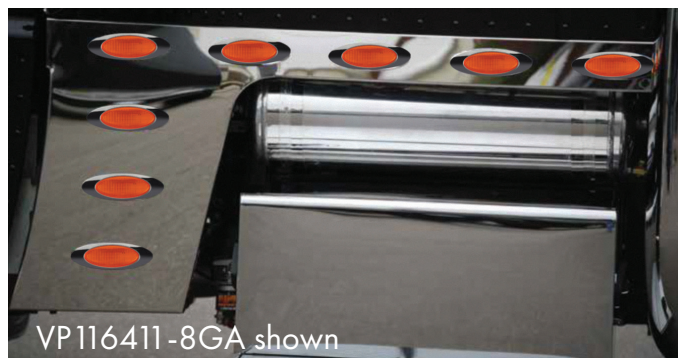

VP116411-8GA shown

# WINGMASTER ACCESSORIES

## PETERBILT MODEL 388 & 389

### ONE-PIECE CAB/HOOD EXTENSION PANELS DEF SYSTEM

#### MOUNTING HARDWARE INCLUDED

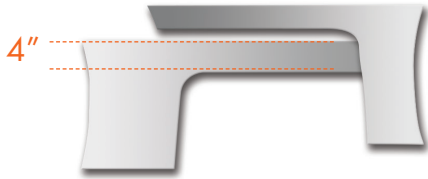

VP116421

PB CAB & WIDE REPLACEMENT PANEL - ONE PIECE - 389 - 2010 & NEWER W/UREA SYSTEM - WIDE REPLACEMENT DRIVERS SIDE - SMALL REPLACEMENT PASSENGERS SIDE - 2.1/4" CAB PANEL DRIVERS SIDE - 4" CAB PANEL PASSENGERS SIDE - BLANK

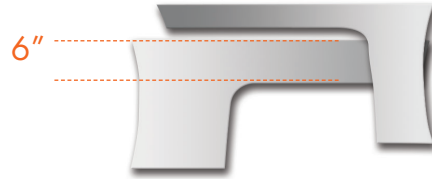

VP116425

PB CAB & WIDE REPLACEMENT PANEL - ONE PIECE - 389 - 2010 & NEWER W/ UREA SYSTEM - WIDE REPLACEMENT DRIVERS SIDE - SMALL REPLACEMENT PASSENGERS SIDE - 2.1/4" CAB PANEL DRIVERS SIDE - 6" CAB PANEL PASSENGERS SIDE - BLANK

**2008-2010 WITH CAT ENGINES USE WIDE PANELS BOTH SIDES  
2009-2010 CUMMINS ENGINES USE WIDE DRIVER SIDE, NARROW PASSENGER**

ADD LIGHTS TO YOUR PANEL – SEE PAGES 106-107

### ONE-PIECE CAB/HOOD EXTENSION PANELS, NO DEF SYSTEM

#### FORMED PANELS • HARDWARE INCLUDED

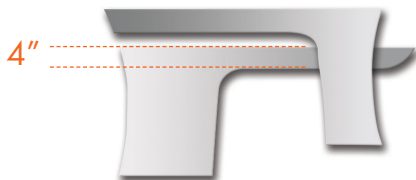

VP114400

PB CAB & WIDE REPLACEMENT PANEL - FORMED ONE PIECE - 389 2009-2011 - NON UREA - WIDE REPLACEMENT DRIVERS SIDE - SMALL REPLACEMENT PASSENGERS SIDE - 4" CAB PANELS - BLANK



VP114411

PB CAB & WIDE REPLACEMENT PANEL - FORMED ONE PIECE - 389 2009-2011 - NON UREA - WIDE REPLACEMENT DRIVERS SIDE - SMALL REPLACEMENT PASSENGERS SIDE - 4" CAB PANELS - WRAP - BLANK

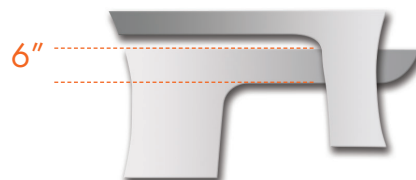

VP114200

PB CAB & WIDE REPLACEMENT PANEL - FORMED ONE PIECE - 389 2009-2011 - NON UREA - WIDE REPLACEMENT DRIVERS SIDE - SMALL REPLACEMENT PASSENGERS SIDE - 6" CAB PANELS - BLANK

VP114211

PB CAB & WIDE REPLACEMENT PANEL - FORMED ONE PIECE - 389 2009-2011 - NON UREA - WIDE REPLACEMENT DRIVERS SIDE - SMALL REPLACEMENT PASSENGERS SIDE - 6" CAB PANELS - WRAP - BLANK

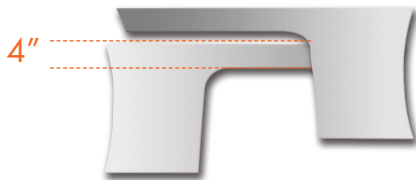

VP114420

PB CAB & WIDE REPLACEMENT PANEL BOTH SIDES - FORMED ONE PIECE - 389 2008 - NON UREA - 4" CAB PANELS - BLANK

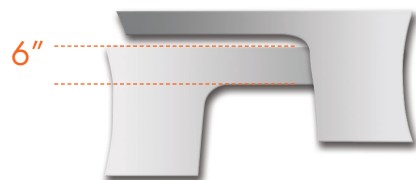

VP114420-6

PB CAB & WIDE REPLACEMENT PANEL BOTH SIDES - FORMED ONE PIECE - 389 2008 - NON UREA - 6" CAB PANELS - BLANK

# WINGMASTER ACCESSORIES

## PETERBILT MODEL 388 & 389

### ONE-PIECE CAB/HOOD EXTENSION PANELS DEF SYSTEM

FORMED PANELS • HARDWARE INCLUDED

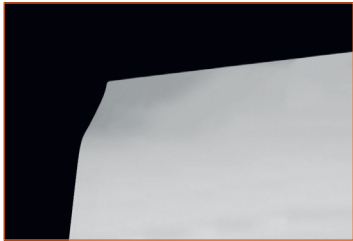

CORNER FOLLOWS  
CONTOUR OF TRUCK



VP114421

PB CAB & WIDE REPLACEMENT PANEL -  
FORMED ONE PIECE - 389 - 2010 & NEWER  
W/ UREA SYSTEM - WIDE REPLACEMENT  
DRIVERS SIDE - SMALL REPLACEMENT  
PASSENGERS SIDE - 2.1/4" CAB PANEL  
DRIVERS SIDE - 4" CAB PANEL  
PASSENGERS SIDE - BLANK



VP114422

PB CAB & WIDE REPLACEMENT PANEL  
- FORMED - ONE PIECE - 388, 389 - 2010  
& NEWER W/ UREA SYSTEM - WIDE  
REPLACEMENT DRIVERS SIDE - SMALL  
REPLACEMENT PASSENGERS SIDE - 4"  
CAB PANEL DRIVERS SIDE - 2.1/4" CAB  
PANEL PASSENGERS SIDE - WRAPPED - BLANK

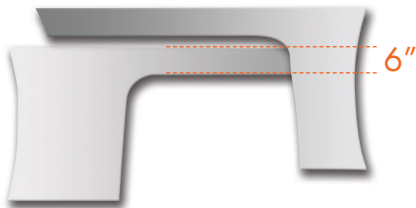

VP114425

PB CAB & WIDE REPLACEMENT PANEL -  
FORMED ONE PIECE - 389 - 2010 & NEWER  
W/ UREA SYSTEM - WIDE REPLACEMENT  
DRIVERS SIDE - SMALL REPLACEMENT  
PASSENGERS SIDE - 2.1/4" CAB PANEL  
DRIVERS SIDE - 6" CAB PANEL  
PASSENGERS SIDE - BLANK



VP114426

PB CAB & WIDE REPLACEMENT PANEL -  
FORMED - ONE PIECE - 388, 389 - 2014 &  
NEWER W/ UREA SYSTEM AND DYNAPLEX  
KIT - WIDE REPLACEMENT DRIVERS SIDE -  
SMALL REPLACEMENT PASSENGERS SIDE  
- 4" CAB PANEL DRIVERS SIDE - 2.1/4" CAB  
PANEL PASSENGERS SIDE - BLANK



VP114427

PB CAB & WIDE REPLACEMENT PANEL -  
FORMED - ONE PIECE - 388, 389 - 2014 &  
NEWER W/ UREA SYSTEM AND DYNAPLEX  
KIT - WIDE REPLACEMENT DRIVERS SIDE -  
SMALL REPLACEMENT PASSENGERS SIDE  
- 4" CAB PANEL DRIVERS SIDE - 2.1/4" CAB  
PANEL PASSENGERS SIDE - WRAPPED - BLANK

**2008-2010 WITH CAT ENGINES USE WIDE PANELS BOTH SIDES  
2009-2010 CUMMINS ENGINES USE WIDE DRIVER SIDE, NARROW PASSENGER**

ADD LIGHTS TO YOUR PANEL – SEE PAGES 106-107



# WINGMASTER ACCESSORIES

## PETERBILT MODEL 388 & 389

### CAB PANELS 4"

#### MOUNTING HARDWARE INCLUDED

##### VP110203

PB CAB PANELS - 1987 &  
NEWER - 379, 388, 389 -  
STANDARD - BLANK - PAIR

##### VP110207

PB CAB PANELS - 1987 &  
NEWER - 379, 388, 389 -  
EXTENDED - BLANK - PAIR

##### VP110227

PB CAB PANELS - 1987 &  
NEWER - 379, 388, 389 -  
STANDARD WRAP - BLANK - PAIR

##### VP110228

PB CAB PANELS - 1987 &  
NEWER - 379, 388, 389 -  
EXTENDED WRAP - BLANK - PAIR

### CAB PANELS 6"

#### MOUNTING HARDWARE INCLUDED

##### VP110250

PB CAB PANELS - 1987 &  
NEWER - 379, 388, 389 -  
STANDARD - BLANK - PAIR

##### VP110251

PB CAB PANELS - 1987 &  
NEWER - 379, 388, 389 -  
EXTENDED - BLANK - PAIR

##### VP110254

PB CAB PANELS - 1987 &  
NEWER - 379, 388, 389 -  
STANDARD WRAP - BLANK - PAIR

##### VP110253

PB CAB PANELS - 1987 &  
NEWER - 379, 388, 389 -  
STANDARD WRAP - BLANK - PAIR

ADD LIGHTS TO YOUR PANEL – SEE PAGES 106-107

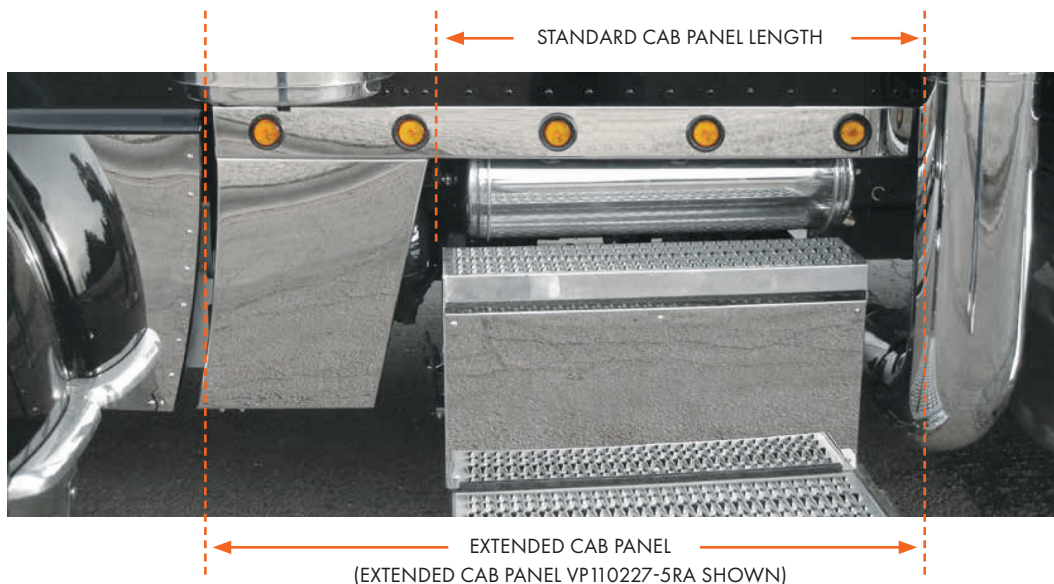

# WINGMASTER ACCESSORIES

## PETERBILT MODEL 388 & 389

### CAB PANELS NO DEF SYSTEM

#### MOUNTING HARDWARE INCLUDED



#### VP113890

PB CAB PANELS - 1987 &  
NEWER - 389 - STANDARD -  
BLANK - PR - 44.38" LONG



#### VP113891

PB CAB PANELS - 1987 &  
NEWER - 389 - STANDARD  
WRAP - BLANK - PR

### CAB PANELS DEF SYSTEM

#### MOUNTING HARDWARE INCLUDED



#### VP110263

PB CAB PANELS - 388,389 - 2010  
& NEWER - STANDARD - W / UREA  
SYSTEM - 2.1/4" PASSENGER SIDE  
- 4" DRIVERS SIDE - BLANK



#### VP110264

PB CAB PANELS - 388,389  
- 2010 & NEWER - WRAP -  
W / UREA SYSTEM - 2.1/4"  
PASSENGER SIDE - 4"  
DRIVERS SIDE - BLANK



#### VP110267

PB CAB PANELS - 389 - 2010 &  
NEWER - EXTENDED - W / UREA  
SYSTEM - 2.1/4" PASSENGER  
SIDE - 4" DRIVERS SIDE - BLANK

**4" WIDE DRIVER SIDE, ALSO AVAILABLE IN 6" WIDTH  
2.25" ONLY ON PASSENGER SIDE**

**ADD LIGHTS TO YOUR PANEL – SEE PAGES 106-107**

# WINGMASTER ACCESSORIES

## PETERBILT MODEL 388 & 389

### SLEEPER PANELS 4"

MOUNTING HARDWARE INCLUDED  
MATCH TO SLEEPER EXTENSION PANELS ON PAGE 165



**VP142004**

PB SLEEPER PANELS - 1987 &  
NEWER - 379, 388, 389 - 36"/44"  
- BLANK - PAIR



**VP142007**

PB SLEEPER PANELS - 1987 &  
NEWER - 379, 388, 389 - 48"/58"  
- BLANK - PAIR



**VP142000**

PB SLEEPER PANELS - 1987 &  
NEWER - 379, 388, 389 - 63"/72"  
- BLANK - PAIR



**VP142002**

PB SLEEPER PANELS - 1987 &  
NEWER - 379, 388, 389 - 70"/78"  
- BLANK - PAIR

ADD LIGHTS TO YOUR PANEL – SEE PAGES 106-107

### SLEEPER PANELS 6"

MOUNTING HARDWARE INCLUDED



**VP142050**

PB SLEEPER PANELS - 1987 &  
NEWER - 379, 388, 389 - 36"/44"  
- BLANK - PAIR



**VP142051**

PB SLEEPER PANELS - 1987 &  
NEWER - 379, 388, 389 - 48"/58"  
- BLANK - PAIR



**VP142052**

PB SLEEPER PANELS - 1987 &  
NEWER - 379, 388, 389 - 63"/72"  
- BLANK - PAIR



**VP142053**

PB SLEEPER PANELS - 1987 &  
NEWER - 379, 388, 389 - 70"/78"  
- BLANK - PAIR

### ADD LIGHT OPTIONS



EXAMPLE  
VP142002 - 8 RA



EXAMPLE  
VP142007 - 4 GA



Peterbilt Truck Models	Original Sleeper Length Designation	New Sleeper Length Designation
365, 367, 379, 384, 386, 388, 389	36"	44"
	48"	58"
	63"	72"
	70"	78"

# WINGMASTER ACCESSORIES

## PETERBILT MODEL 388 & 389

### HOOD EXTENSION PANELS 4"

MOUNTING HARDWARE INCLUDED (EXCEPT VP110314 TAPE MOUNT)



VP110313

PB 389 - HOOD EXTENSION  
PANEL - FACTORY  
REPLACEMENT - PAIR



VP110314

PB 389 - HOOD EXTENSION  
PANEL - FACTORY LAYOVER  
- PAIR, TAPE MOUNT

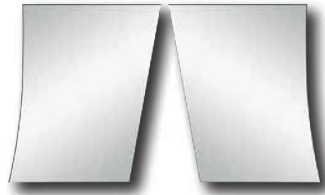

VP110308

PB 389 - HOOD EXTENSION  
PANEL - WIDE REPLACEMENT  
- BLANK - PAIR



VP110309

PB 389 - HOOD EXTENSION  
PANEL - WIDE REPLACEMENT  
NOTCHED - BLANK - PAIR

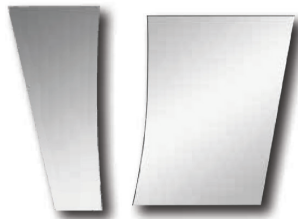

VP110311

PB 389 - HOOD EXTENSION  
PANEL - WIDE REPLACEMENT  
- BLANK - W/DEF - PAIR

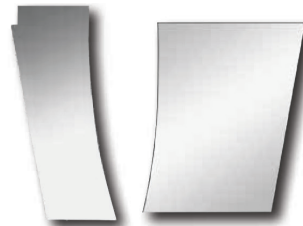

VP110312

PB 389 - HOOD EXTENSION PANEL  
- WIDE REPLACEMENT NOTCHED -  
BLANK - W/DEF - PAIR

### HOOD EXTENSION PANELS 6"

MOUNTING HARDWARE INCLUDED



VP110364

PB 389 - HOOD EXTENSION  
PANEL - FACTORY  
REPLACEMENT - PAIR

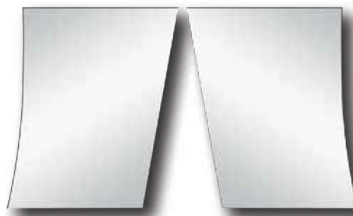

VP110366

PB 389 - HOOD EXTENSION  
PANEL - WIDE REPLACEMENT  
- BLANK - PAIR



VP110367

PB 389 - HOOD EXTENSION  
PANEL - WIDE REPLACEMENT  
NOTCHED - BLANK - PAIR

# WINGMASTER ACCESSORIES

## PETERBILT MODEL 388 & 389

### HOOD EXTENSION PANELS 4"

#### MOUNTING HARDWARE INCLUDED

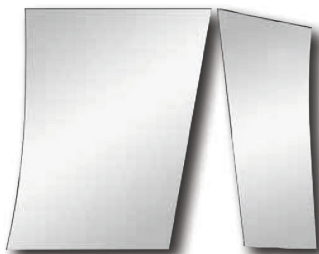

VP110307

PB 389 - HOOD EXTENSION  
PANEL - WIDE REPLACEMENT  
- BLANK - W/PICKETT  
EXHAUST ELBOWS - PAIR

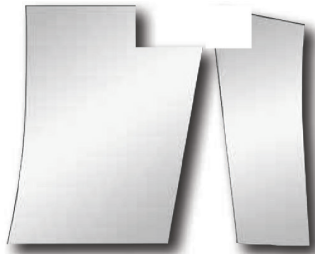

VP110397

PB 389 - HOOD EXTENSION  
PANEL - WIDE REPLACEMENT  
- NOTCHED- BLANK - W/  
PICKETT EXHAUST ELBOWS - PAIR

### HOOD EXTENSION PANELS 6"

#### MOUNTING HARDWARE INCLUDED

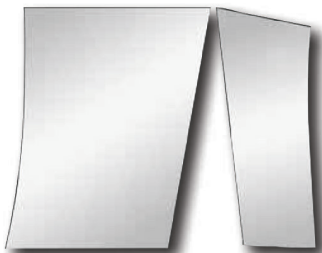

VP110379

PB 389 - HOOD EXTENSION  
PANEL - WIDE REPLACEMENT  
- BLANK - W/PICKETT  
EXHAUST ELBOWS - PAIR

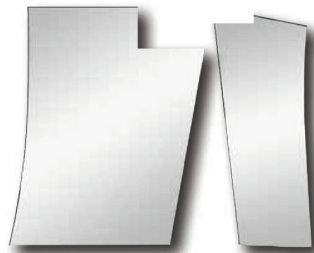

VP110398

PB 389 - HOOD EXTENSION  
PANEL - WIDE REPLACEMENT  
- NOTCHED- BLANK - W/  
PICKETT EXHAUST ELBOWS - PAIR

#### ADD LIGHT OPTIONS

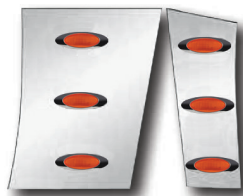

EXAMPLE  
VP110307-3GA

ADD LIGHTS TO YOUR PANEL – SEE PAGES 106-107

# WINGMASTER ACCESSORIES

## PETERBILT MODEL 388 & 389

### 388 CAB PANEL DEF SYSTEM

MOUNTING HARDWARE INCLUDED



VP110229

2012 AND NEWER 388 W/DEF  
WITH VERTICAL EXHAUST  
PASSENGER SIDE 35", DRIVER SIDE 40"

ADD LIGHTS TO YOUR PANEL – SEE PAGES 106-107

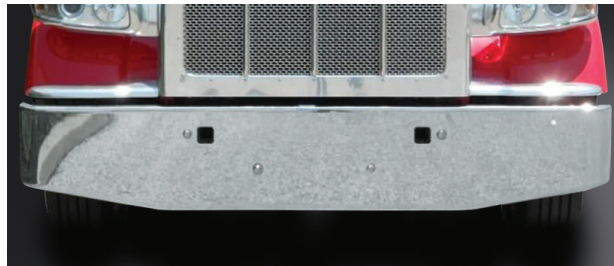

Also check out our model 388 & 389  
bumpers, page 62



# WINGMASTER ACCESSORIES

## PETERBILT MODEL 388 & 389

### SLEEPER EXTENSION PANELS 4"

MOUNTING HARDWARE INCLUDED

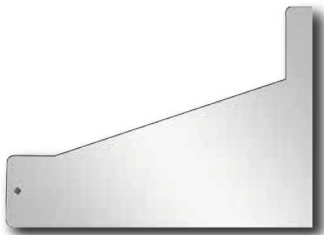

**VP142101**  
PB SLEEPER EXTENSION  
PANEL - 1987 & NEWER - 379,  
388, 389 - 63"/72" - BLANK

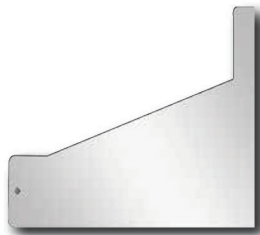

**VP142103**  
PB SLEEPER EXTENSION  
PANEL - 1987 & NEWER - 379,  
388, 389 - 70"/78" - BLANK



### SLEEPER EXTENSION PANELS 6"

MOUNTING HARDWARE INCLUDED

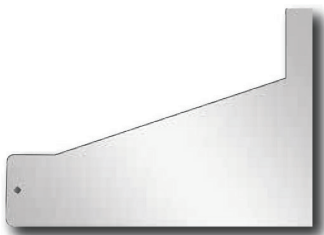

**VP142150**  
PB SLEEPER EXTENSION  
PANEL - 1987 & NEWER - 379,  
388, 389 - 63"/72" - BLANK

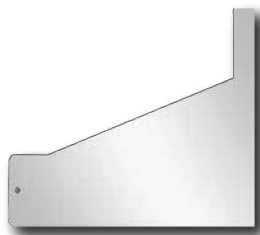

**VP142151**  
PB SLEEPER EXTENSION  
PANEL - 1987 & NEWER - 379,  
388, 389 - 70"/78" - BLANK



ADD LIGHTS TO YOUR PANEL –  
SEE PAGES 106-107

Peterbilt Truck Models	Original Sleeper Length Designation	New Sleeper Length Designation
365, 367, 379, 384, 386, 388, 389	36"	44"
	48"	58"
	63"	72"
	70"	78"

EXAMPLE  
VP142101-1GA



# WINGMASTER ACCESSORIES

## PETERBILT MODEL 388 & 389

### AIR CLEANER LIGHT BOXES DONALDSON

CONNECT TO AIR CLEANER STRAPS:



VP112109

PB - AIR CLEANER LIGHTS - BLANK -  
- 388, 389 - 2007 & NEWER - PR -  
DONALDSON/PREMIUM - FRONT



VP113109

PB - AIR CLEANER LIGHTS - BLANK -  
REAR - 388, 389 - 2007 & NEWER - PR -  
DONALDSON/PREMIUM - REAR

FOR STRAPLESS LOOK:



VP112209

PB - AIR CLEANER SUPPORT - BLANK -  
379, 388, 389 - 2007 & NEWER - PAIR

ADD LIGHTS TO YOUR PANEL – SEE PAGES 106-107



VP112109-7RA

PB - AIR CLEANER LIGHTS - 8 ROUND  
AMBERS - 388, 389 - 2007 & NEWER - PAIR -  
DONALDSON/PREMIUM

Don't Forget the  
Light Harness:



VHMS3007

1 - PACCAR - FEMALE 2 - PACCAR - MALE  
- FOR CONNECTING FRONT & REAR AIR  
CLEANER LIGHTS



# WINGMASTER ACCESSORIES

## PETERBILT MODEL 388 & 389

### MIRROR LIGHT BOXES



**VP114011**  
MIRROR LIGHT BOXES - 379,  
388, 389 - CAB MOUNTED  
MIRRORS - BLANK



ADD -SM WITH BUILT IN SPOT MIRRORS

ADD LIGHTS TO YOUR PANEL – SEE PAGES 106-107

#### EXAMPLES:



**VP114011-2GA**  
MIRROR LIGHT BOXES - 379,  
388, 389 - CAB MOUNTED  
MIRRORS - 2 - GRANITE -  
AMBER LEDS



**VP114011-5RCA**  
MIRROR LIGHT BOXES - 379,  
388, 389 - CAB MOUNTED  
MIRRORS - 5 - 2" ROUNDS -  
CLEAR AMBER LEDS



**VP114011-2SCA**  
MIRROR LIGHT BOXES - 379,  
388, 389 - CAB MOUNTED  
MIRRORS - 2 - SLOTTED -  
CLEAR AMBER LEDS



**VP114011-5RA**  
MIRROR LIGHT BOXES - 379,  
388, 389 - CAB MOUNTED  
MIRRORS - 5 - 2" ROUNDS -  
AMBER LEDS

# WINGMASTER ACCESSORIES

## PETERBILT MODEL 388 & 389

### BUMPER & GRILLE TRIM



**VP120000**

PB TAG HANGER  
(388, 389)

INCLUDES HARDWARE, FOAM  
PROTECTORS AND PLASTIC  
LICENSE PLATE BOLT INSERTS

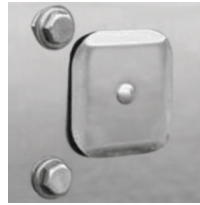

**VK120003**

TOW PIN COVER FITS 389



**VP120012**

PB SIDE GRILL

DEFLECTOR 379, 388, 389

SEE PAGE 95 FOR MORE TAG HANGERS

### FENDER GUARDS



**VP120013**

PB FENDER GUARDS -  
HEAD LIGHT MOUNT - 388,  
389 - 2007 & NEWER



**VP120014**

PB FENDER GUARDS - PB -  
HEAD LIGHT MOUNT  
- 389 - W/BLINKER BAR - PR

### BUG SHIELDS



**VP120110**

PB BUG SHIELD - STAINLESS  
- 367, 388, 389

MOUNTING HARDWARE INCLUDED



# WINGMASTER ACCESSORIES

## PETERBILT MODEL 388 & 389

### EMBLEMS



**VP100032**  
PB 389 EMBLEM ACCENT -  
RACING STRIPE -  
LONG HOOD  
INCLUDES MOUNTING HARDWARE



**VP100033**  
PB 389 EMBLEM ACCENT -  
RACING STRIPE  
- SHORT HOOD  
TAPE MOUNT



**VP100040**  
PB 389 HOOD LATCH  
GUARD - PAIR  
INCLUDES MOUNTING  
HARDWARE

### FENDER TRIM



**VP100123**  
PB 389 FENDER  
TRIM - INNER WELL - 2PC  
TAPE MOUNT



**VP100122**  
PB389 FENDER TRIM - 2PC  
TAPE MOUNT

### HOOD TRIM

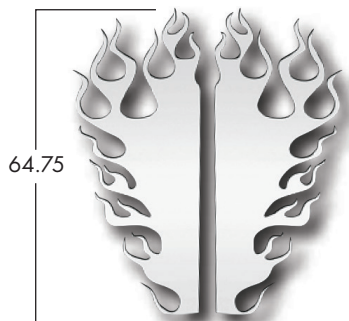

**VP100124**  
PB 389 CENTER HOOD TRIM  
2PC FLAME



**VP100121**  
PB CENTER HOOD TRIM - 389  
SCREW ON

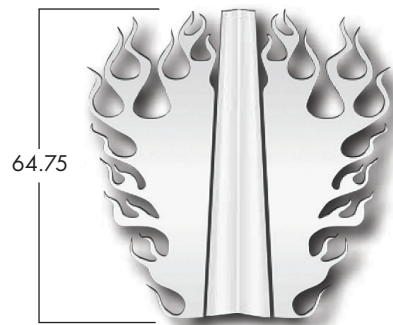

**VP100125**  
PB 389 CENTER HOOD TRIM  
3PC FLAME (VP100121,  
VP100124)

# WINGMASTER ACCESSORIES

## PETERBILT MODEL 388 & 389

### BLINKER BARS

RUBBER TRIM AND MOUNTING HARDWARE INCLUDED



#### VP120502

PB 389 FRONT BLINKER BARS  
- W/LEDS - PAIR

NOTE: ALREADY HAS SLOTTED  
LIGHT HOLES AND LIGHTS, NO  
NEED TO BUILD AS CUSTOM



#### VP100502

PB 389 REAR BLINKER BARS -  
- W/LEDS - PAIR

NOTE: ALREADY HAS SLOTTED  
LIGHT HOLES AND LIGHTS, NO  
NEED TO BUILD AS CUSTOM

### FENDER SUPPORT COVERS

RUBBER TRIM AND MOUNTING HARDWARE INCLUDED



#### VP120503

PB 389 FENDER SUPPORT  
COVER - FRONT  
TOO NARROW FOR LIGHT OPTIONS



#### VP100503

PB 389 FENDER SUPPORT  
COVER - REAR  
TOO NARROW FOR LIGHT OPTIONS

VP120502

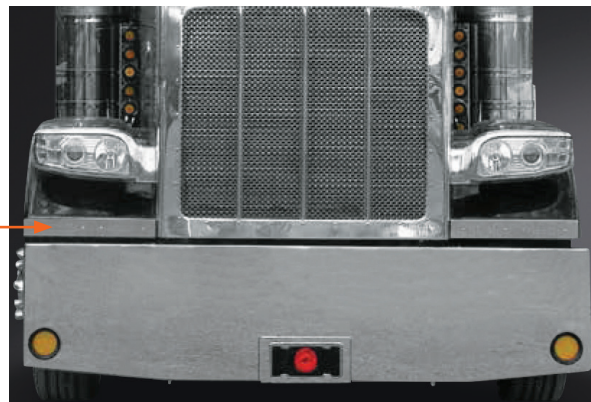

# WINGMASTER ACCESSORIES

## PETERBILT MODEL 388 & 389

### STAINLESS VISORS



#### VP130013

PB - 389 14" - DROP VISOR - 2007 - NEWER  
STANDARD W/ CAB MTD. MIRRORS CURVED  
WINDOW, ONE PIECE WINDSHIELD  
ALSO FITS MODEL 348

**PAINTABLE  
VISORS  
AVAILABLE**

JUST ADD "P" TO THE END  
FOR PAINTABLE. EXAMPLE:

VP130013-P  
RAW 18 GAUGE STEEL

ADD LIGHTS TO YOUR VISOR -  
SEE PAGES 106-107 FOR LIGHT OPTIONS

FOR MORE PETE VISORS SEE PAGES 198-201

### SLEEPER FILLER PANELS

MOUNTING HARDWARE INCLUDED



#### VP140021

PB SLEEPER REAR CORNER  
FILLER PANELS 70" ONLY -  
379, 389 - 4 - 4" LEDS - PAIR

# WINGMASTER ACCESSORIES

## PETERBILT MODEL 388 & 389

### MISC. TRIM PIECES



**VP101001**  
PB 389 LOWER HOOD PANEL -  
2007 & NEWER - PAIR



**VP100038**  
PB - 389 FRONT FLAP  
WEIGHTS - 11 GA - PAIR



**VP110018**  
PB WINDSHIELD TRIM - 5 PC  
379, 389 - LARGE



**VPTF18022**  
PB OUTER FENDER  
TRIM - 389  
DOES NOT FIT 388  
SOLD AS A SET OF 3 PAIR

**VPTF18022S**  
FOR ONE PAIR



**VP110017**  
PB 388/389 TOP OF DOOR TRIM - LOWERED LOOK - PAIR  
WILL ONLY FIT DOORS WITHOUT VENT WINDOW

**VP110017P**



ADD -P FOR PAINTABLE

# WINGMASTER ACCESSORIES

## PETERBILT MODEL 388 & 389

### MISC. TRIM PIECES



**VP110020**  
PB - OUTSIDE DOOR TRIM -  
389 - 2-PCS  
TAPE MOUNT



**VP110025**  
PB 379, 388, 389 WINDSHIELD WIPER  
ARM COVERS  
TAPE MOUNT



**VP110019**  
PB 389 OUTSIDE DOOR TRIM -  
CORNER ANGLE - PAIR  
TAPE MOUNT



**VP110090**  
PB EXHAUST SHIELDS -  
388, 389 - W/NO LOGO  
BRACKETS & HARDWARE INCLUDED

# WINGMASTER ACCESSORIES

## PETERBILT MODEL 388 & 389

### SLEEPER SHOCK COVERS



**VP140034**  
PB SLEEPER SHOCK COVERS  
- 379, 389 - 2 PCS (L+R)  
ANGLED  
TAPE MOUNT



**VP140022**  
PB 379, 389 SLEEPER SHOCK  
COVERS - 2 PAIR  
TAPE MOUNT

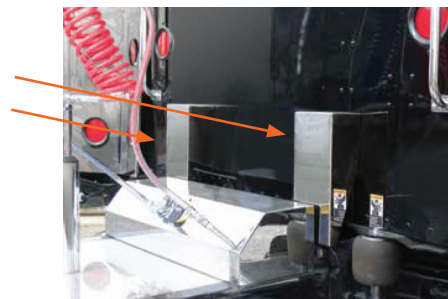

**VP140032**  
PB SLEEPER SHOCK COVERS  
- 379,389 - 1 LG FULL COVER  
TAPE MOUNT

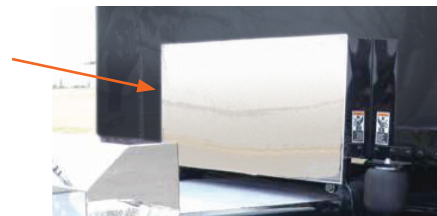

**VP140035**  
PB SLEEPER SHOCK COVER -  
379,389 ANGLED FULL COVER



**VP140033**  
PB SLEEPER SHOCK COVERS  
- 379,389 - 1 LG CURVED FULL COVER

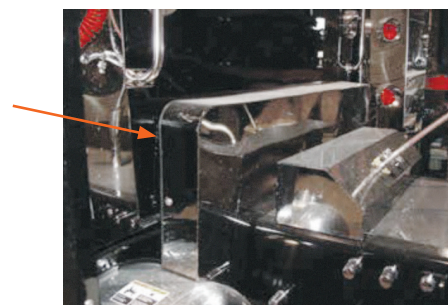

RUBBER STRIP & HARDWARE INCLUDED

### AIR DEFLECTORS



**VP110016**  
PB 359 - 379, 389 WINDOW  
AIR DEFLECTORS  
TAPE MOUNT



**VP110031**  
PB 359 - 379, 389 WINDOW  
AIR DEFLECTORS W/LOWER  
LOOKS( VP110017 )WINDOW  
TRIM 37.25" X 20.375"  
TAPE MOUNT



# WINGMASTER ACCESSORIES

## PETERBILT MODEL 388 & 389

### FUEL TANK STRAP COVERS

BRACKETS & MOUNTING HARDWARE INCLUDED



VP150020  
PB - FUEL TANK STRAP  
COVERS - 4PCS



VP150029  
PB - FUEL TANK STRAP  
COVERS - 2PCS  
NOT 359



VP150029R  
PB - FUEL TANK STRAP  
COVERS - ROUND - 2PCS  
ALL BUT 359



### EXHAUST COVERS



VP150021  
PB - 389 EXHAUST COVER -  
PASSENGER SIDE - FITS 06  
FITS 06 - JULY 07



VP150022  
PB - 389 EXHAUST COVER -  
DRIVERS SIDE - FITS 06 - JULY  
FITS 06 - JULY 07



VP150023  
PB - 388, 389 EXHAUST COVER  
- PASSENGER & DRIVERS SIDE  
FITS 06 - JULY 07



QUALITY TRUCK PARTS

# WINGMASTER ACCESSORIES

## PETERBILT MODEL 388 & 389

### TOOL & BATTERY BOX COVERS

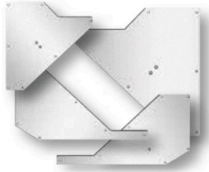

**VP150000**

PB BATTERY BOX STAINLESS  
COVER KIT - 389 - 2013-OLDER  
- 4 PCS

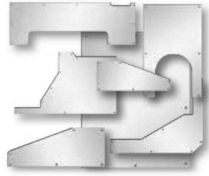

**VP150009**

PB TOOL BOX STAINLESS  
COVER KIT - 389 - 2013-OLDER  
- CATALYTIC COVER PASS  
SIDE - 7 PCS



**VP150005**

PB TOOL BOX COVER - 389



**VP150006**

PB BATTERY BOX COVER - 389  
WITH 1" LIP



**VP150007**

PB TOOL & BATTERY BOX  
COVERS - 389 WITH 1" LIP - 2 PCS



**VP150008**

PB TOOL & BATTERY BOX  
STEP TRIMS - 389 - 4 PCS



**VP150014**

PB 389 TOOL BOX FILLER  
BLOCK FOR BOTTOM STEP



**VP150018**

PB 389 BATTERY BOX COVER  
MOLDED - 3PCS



**VP150019**

PB 389 BATTERY BOX LOWER  
STEP COVER W/SIDES - 3PCS

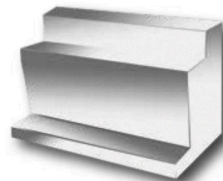

**VP150024**

PB - 389 UREA CATALYTIC  
COVER 3PC COVER - '12 AND  
OLDER

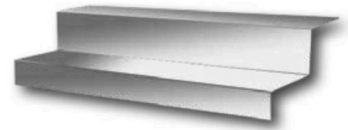

**VP150025**

PB - 389 UREA CATALYTIC  
COVER HIGHLIGHT - UPPER -  
'12 AND OLDER

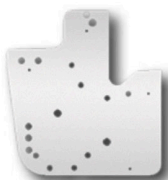

**VP150042**

PB - 389 - 2014 UREA  
CATALYTIC COVER HIGHLIGHT  
- SIDES - 2PCS

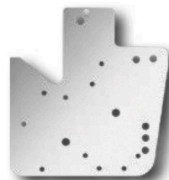

**VP150027**

PB - 389 - 2013-OLDER UREA  
CATALYTIC COVER HIGHLIGHT  
- SIDES - 2PCS

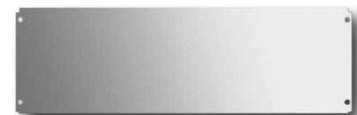

**VP150026**

PB - 389 UREA CATALYTIC  
COVER HIGHLIGHT - LOWER

ADD "P" FOR PAINTABLE

# WINGMASTER ACCESSORIES

## PETERBILT MODEL 388 & 389

### BATTERY BOXES & TOOL BOXES

STANDARD WIDTH 30" / CUSTOM WIDTHS AVAILABLE UP TO 48"

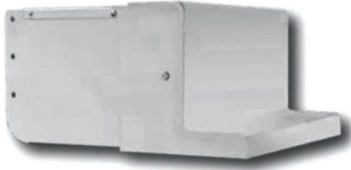

VP150112 - PB - 379,388, 389 REAR TOOL BOX - STAINLESS W/LOCKS - MOULDED LID

VP150113 - PB - 379, 388, 389 BATTERY BOX - STAINLESS W/LOCKS - MOULDED LID

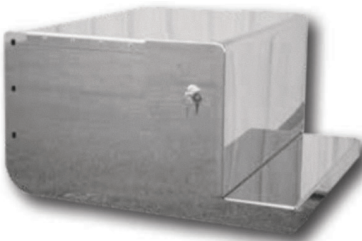

VP150109R - PB - 379, 388, 389 REAR TOOL BOX - STAINLESS W/LOCKS - ROUNDED SMOOTH LOOK

VP150110R - PB - 379, 388, 389 BATTERY BOX - STAINLESS W/LOCKS - ROUNDED SMOOTH LOOK

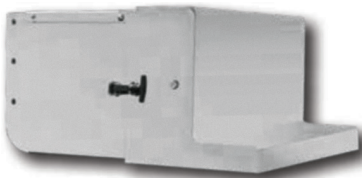

VP150115 - PB - 379,388, 389 REAR TOOL BOX - STAINLESS W/LOCKS - MOULDED LID

VP150116 - PB - 379, 388, 389 BATTERY BOX - STAINLESS W/LOCKS - MOULDED LID

VP150116TM - PB - 379, 388, 389 BATT, BOX - STAINLESS W/TIE DOWNS - 18" TALL MOULDED LID

ADD -36 TO ANY STAINLESS TOOL BOX PART NUMBER FOR A 36" BOX  
ADD -48 TO ANY STAINLESS TOOL BOX PART NUMBER FOR A 48" BOX

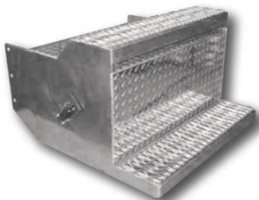

VP150103

PB - 379, 388, 389 BATTERY BOX - ALUMINUM



VP150104

PB - 379, 388, 389 BATTERY BOX - ALUMINUM



### BOX STEP HIGHLIGHTS/PROTECTORS



VP150030

PB TOOL BOX/BATTERY BOX - STEP PROTECTOR-(18") - WICKED PR

VP150031

PB TOOL BOX/BATTERY BOX - STEP PROTECTOR- (30") WICKED PAIR

PAINTED OPTIONS SHOWN



# WINGMASTER ACCESSORIES

## PETERBILT MODEL 567



Bumpers and Stainless Accessories made in the USA



[www.valleychrome.com](http://www.valleychrome.com)

# WINGMASTER ACCESSORIES

## PETERBILT MODEL 567

### CAB PANEL

MOUNTING HARDWARE INCLUDED

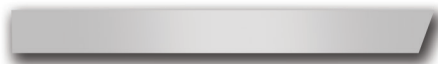

VP110277

PB CAB PANELS - 567 - BLANK

### SLEEPER PANELS

MOUNTING HARDWARE INCLUDED



VP140283

PB SLEEPER PANELS -  
567 - 80" - BLANK W/REAR  
EXHAUST



VP142079

PB SLEEPER PANELS - 567 & 579 - 80" -  
EXHAUST BEHIND SLEEPER

Peterbilt Truck Models	Original Sleeper Length Designation	New Sleeper Length Designation
567, 579	36"	44"
	63"	72"
	(N/A)	80"

### HOOD EXTENSION PANELS

### FENDER GUARDS



VP110401

PB 567 - HOOD EXTENSION  
PANEL - FILLER PANEL



VP110402

PB 567 - HOOD EXTENSION  
PANEL - FACTORY LAYOVER  
TAPE MOUNT



VP110403

PB 567 - HOOD  
EXTENSION PANEL - WIDE  
REPLACEMENT - BLANK - PAIR



VP120019

PB FENDER GUARD - 567  
FITTED 4PCS. UPPER &  
LOWER

# WINGMASTER ACCESSORIES

---

## PETERBILT MODEL 567

### BUG SHIELDS



VP120114  
PB BUG SHIELD - STAINLESS  
567, 579  
MOUNTING HARDWARE INCLUDED

### FUEL TANK STRAP COVERS

BRACKETS & MOUNTING HARDWARE INCLUDED



VP150048  
PB - 567 FUEL TANK STRAP  
COVERS - 4PCS



**QUALITY TRUCK PARTS**

# WINGMASTER ACCESSORIES

## PETERBILT MODEL 567

### STAINLESS VISORS

VP130007

PB - 12" - DROP VISOR 2013 579 DAY CAB  
ALSO FITS MODEL 567

**PAINTABLE  
VISORS  
AVAILABLE**

JUST ADD "P" TO THE END  
FOR PAINTABLE. EXAMPLE:

VP130007P  
RAW 18 GAUGE STEEL



PAINTABLE CUSTOM VISOR SHOWN  
VP130007P-16-10BYA

ADD LIGHTS TO YOUR VISOR – SEE PAGES 106-107

FOR MORE PETE VISORS SEE PAGES 198-201



# WINGMASTER ACCESSORIES

## PETERBILT MODEL 579



Bumpers and Stainless Accessories made in the USA



[www.valleychrome.com](http://www.valleychrome.com)



# WINGMASTER ACCESSORIES

## PETERBILT MODEL 579

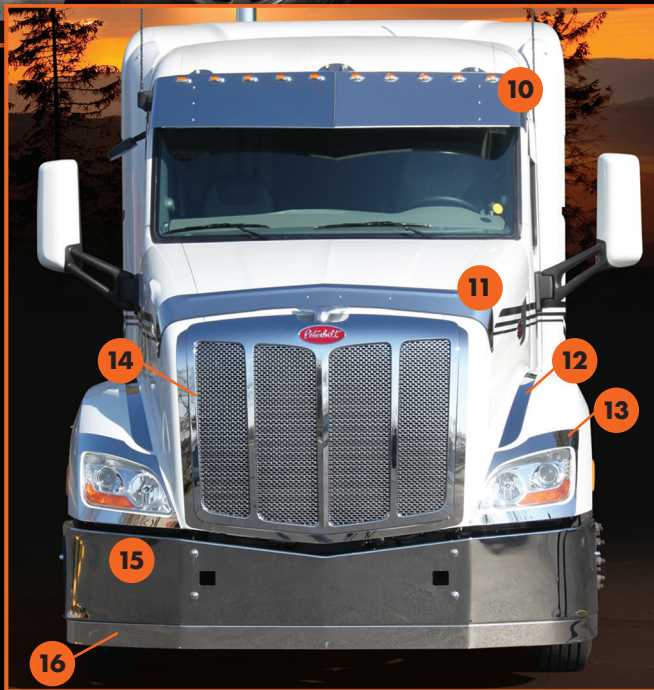

- 1 VP110028** Top of door trim – “lowered” look
- 2 VP140029** Sleeper door handle outer trim with fire extinguisher cutout
- 3 VP142077** Sleeper panels – driver & pass. sides (shown with optional light cutouts)
- 4 VP150112-21** Tool box 21”
- 5 VP150032** Fuel tank fairing upper highlight trim
- 6 VP150034** Kick panel trim
- 7 VP110271** Cab panel with heater plug cutout (shown with optional light cutouts)
- 8 VP110029** Lower door highlight trim
- 9 VP100127** Fender highlight trim (4 pcs driver & passenger sides)
- 10 VP130008** Visor (VP130008-10GMA shown)
- 11 VP120114** Bug shield
- 12 VP100126** Fender highlight, 2 pcs (inner well)
- 13 VP120018** Fender guards
- 14 VP100034** Front hood bug guards (3 pcs.)
- 15 HZ-0010-16Y** Front bumper (other options available)
- 16 HZ-SP** Front bumper air dam

Bumpers and Stainless Accessories made in the USA



[www.valleychrome.com](http://www.valleychrome.com)

# WINGMASTER ACCESSORIES

## PETERBILT MODEL 579

### CAB PANELS

MOUNTING HARDWARE INCLUDED  
ULTRA AND ULTRA LOFT CABS USE SAME PANELS



**VP110270**  
PB CAB PANELS - 579 - BLANK - 2 PCS



**VP110271**  
PB CAB PANELS - 579 - BLANK  
W/HEATER PLUG HOLE - 2 PCS



**VP110276**  
PB CAB PANELS - 579 - BLANK -  
SHORT HOOD - 2016



**VP110272**  
PB CAB PANELS - 579 DAY  
CAB OR VERT EXHAUST  
BLANK - 2 PCS



**VP110273**  
PB CAB PANELS - 579 DAY CAB OR  
VERT EXHAUST - BLANK W/HEATER  
PLUG HOLE - 2 PCS

### SLEEPER PANELS

MOUNTING HARDWARE INCLUDED



**VP142075**  
PB SLEEPER PANELS - 579  
- 36"/44" - EXHAUST BEHIND  
SLEEPER



**VP142077**  
PB SLEEPER PANELS - 579 -  
63"/72" - BLANK



**VP142078**  
PB SLEEPER PANELS - 579  
- 80" - BLANK W/FRONT  
EXHAUST



**VP142079**  
PB SLEEPER PANELS - 579 - 80" -  
EXHAUST BEHIND SLEEPER

Peterbilt Truck Models	Original Sleeper Length Designation	New Sleeper Length Designation
567, 579	36"	44"
	63"	72"
	(N/A)	80"

ADD LIGHTS TO YOUR PANEL – SEE PAGES 106-107

VP110271-4GMA



# WINGMASTER ACCESSORIES

## PETERBILT MODEL 579

### DEF SYSTEM PANELS

BRACKETS & MOUNTING HARDWARE INCLUDED



**VP150043**  
PB - 579 DEF CATALYTIC  
COVER HIGHLIGHT - UPPER

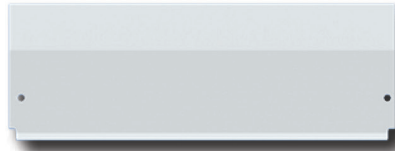

**VP150044**  
PB - 579 DEF CATALYTIC  
COVER HIGHLIGHT - LOWER



**VP150045W**  
PB - 579 DEF CATALYTIC  
LOWER STEP COVER - WING STYLE



**VP150046**  
PB - 579 DEF CATALYTIC  
EXHAUST COVER -  
DYNAFLEX EXHAUST

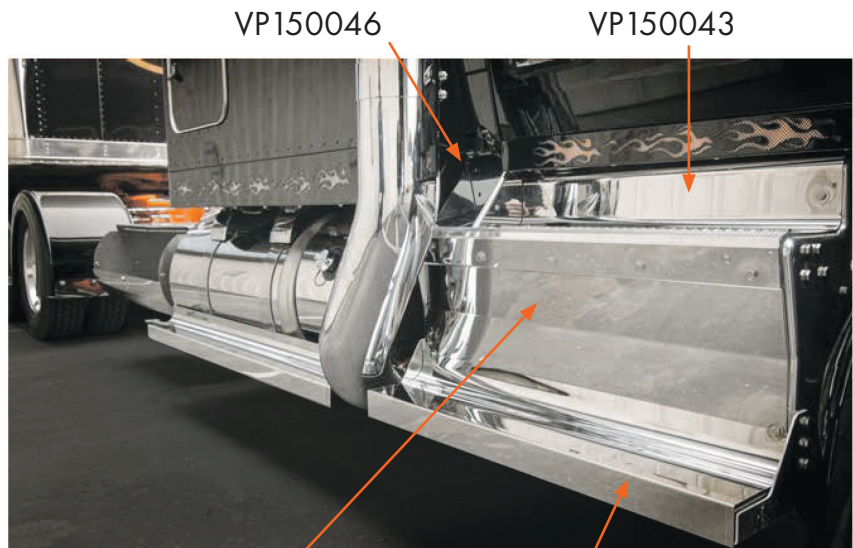

VP150046

VP150043

VP150044

VP150045W



# WINGMASTER ACCESSORIES

## PETERBILT MODEL 579

### MISC. TRIM PIECES



**VP100126**  
PB 579 FENDER  
HIGHLIGHT - INNER WELL 2 PCS  
TAPE MOUNT



**VP100127**  
PB 579 FENDER  
TRIM DS/PS - 4PC  
TAPE MOUNT



**VP100034**  
PB 579 FRONT HOOD GRILLE SURROUND  
TAPE MOUNT



**VP110028**  
PB 579 TOP OF DOOR TRIM -  
LOWERED LOOK - PAIR  
TAPE MOUNT



**VP110030**  
PB 579 TOP OF DOOR TRIM -  
LOWERED LOOK - PAIR - W/MIRROR  
HOLES PASS. SIDE



# WINGMASTER ACCESSORIES

## PETERBILT MODEL 579

### MISC. TRIM PIECES



VP110029  
PB - 579 LOWER DOOR  
HIGHLIGHT - 2PC



VP120018  
PB FENDER GUARD - 579  
FITTED 4PCS. UPPER &  
LOWER



VP120114  
PB BUG SHIELD - STAINLESS  
567,- 579  
MOUNTING HARDWARE INCLUDED

# WINGMASTER ACCESSORIES

## PETERBILT MODEL 579

### STAINLESS VISORS



#### VP130007

PB - 12" - DROP VISOR 2013 TO 2019 579 DAY CAB ONLY  
ALSO FITS MODEL 567, DOES NOT FIT ULTRA LOFT

#### VP130008

PB - 14" - DROP VISOR 2013 TO 2019 579 RAISED ROOF ULTRACAB  
NOTE: MOUNTS TO EXISTING FACTORY VISOR BRACKETS  
NO OTHER MOUNTING BRACKETS PROVIDED

**PAINTABLE  
VISORS  
AVAILABLE**

JUST ADD "P" TO THE END  
FOR PAINTABLE. EXAMPLE:

VP130008-P  
RAW 18 GAUGE STEEL



VP130008-10GMA SHOWN

ADD LIGHTS TO YOUR VISOR – SEE PAGES 106-107



#### VP132008

PB - 18" GANGSTER VISOR - FITS 579  
ULTRA CAB ONLY, DOES NOT FIT ULTRA LOFT



#### VP132008-BF

PB - 18" GANGSTER VISOR -  
BUTTERFLY - FITS 579  
ULTRA CAB ONLY, DOES NOT FIT ULTRA LOFT



#### VP130014

PB - 16" STD MOUNT DROP VISOR  
579 ULTRA LOFT ONLY

FOR MORE PETE VISORS SEE PAGES 198-201

# WINGMASTER ACCESSORIES

## PETERBILT MODEL 579

### SLEEPER SHOCK COVERS

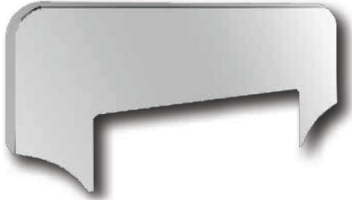

**VP140037**  
PB SLEEPER SHOCK/  
BREATHER COVER - 579 FULL COVER  
RUBBER STRIP & MOUNTING  
HARDWARE INCLUDED



**VP140036**  
PB SLEEPER BREATHER  
COVERS - 579 - 2 PCS ANGLED  
TAPE MOUNT

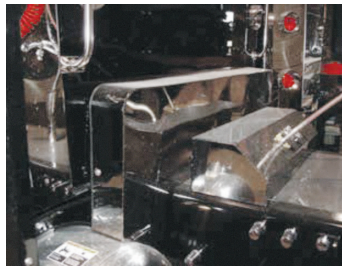

**VP140038**  
PB SLEEPER SHOCK COVER -  
579 FULL COVER  
RUBBER STRIP & MOUNTING  
HARDWARE INCLUDED

### TANK FAIRING HIGHLIGHT



**VP150032**  
PB - 579 FUEL TANK FAIRING  
UPPER HIGHLIGHT - 2PCS  
TAPE MOUNT



### KICK PANEL TRIM



**VP150034**  
PB - 579 DOOR ENTRY KICK  
PANELS - 2PCS

# WINGMASTER ACCESSORIES

## PETERBILT MODEL 587

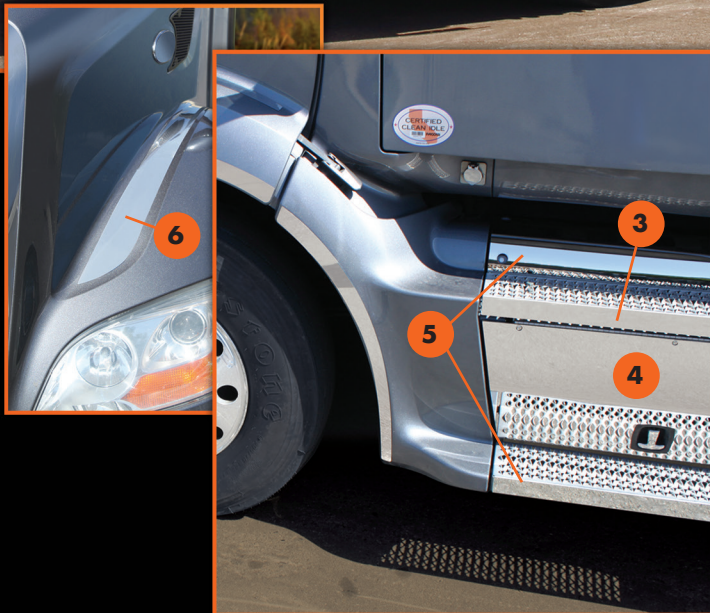

- 1 VP13011** Drop visor, 16", for raised roof
- 2 VP100129** Outer fender trim kit (4 pieces – driver & pass. sides)
- 3 VP150036** Door entry kick panels (2 pieces – driver & pass. sides)
- 4 VP150037** Tool box / battery box cover (One pair – driver & pass. sides)
- 5 VP150038** Step highlights, upper & lower (4 pieces – driver & pass. sides)
- 6 VP100128** Fender inner highlight (2 pieces – driver & pass. sides)
- 7 HOA-0010-16** Chrome bumper, 16" wide (other options available)
- 8 HOA-SP** Stainless air dam for bumper

Bumpers and Stainless Accessories made in the USA



[www.valleychrome.com](http://www.valleychrome.com)



# WINGMASTER ACCESSORIES

## PETERBILT MODEL 587

### FENDER TRIM



VP100128  
PB 587 FENDER  
HIGHLIGHT DS/PS - 2PC



VP100129  
PB 587 FENDER  
TRIM DS/PS - 4PC



### STAINLESS VISORS

**PAINTABLE  
VISORS  
AVAILABLE**

JUST ADD "P" TO THE END  
FOR PAINTABLE. EXAMPLE:

VP130011P  
RAW 18 GAUGE STEEL

VP130011

PB - 587 16" DROP VISOR - 2011 AND NEWER RAISED ROOF



ADD LIGHTS TO YOUR VISOR – SEE PAGES 106-107

# WINGMASTER ACCESSORIES

## PETERBILT MODEL 587

### MISC. TRIM PIECES



**VP150036**

PB - 587 DOOR ENTRY KICK  
PANELS - 2PCS



**VP150037**

PB - 587 TOOL/BATTERY BOX  
COVER - 2 PCS



**VP150038**

PB - 587 O STEP HIGHLIGHTS  
- 4 PCS



# WINGMASTER ACCESSORIES

## PETERBILT MODEL 589



1. **VP130017** - 12" DROP VISOR (MOUNTS TO FACTORY BRACKETS)
2. **VP112120** - **7GSCA** FRONT AIRCLEANER LITE BAR W/7 GRANITE SLIM CLEAR AMBERS
3. **VP110420** - **4GSCA** HOOD EXTENSION W/4 GRANITE SLIM CLEAR AMBERS
4. **VP110221** - **3GSCA** DRIVER-SIDE CAB PANEL W/3 GRANITE SLIM CLEAR AMBERS
5. **VP113120** - **7GSCR** REAR AIRCLEANER LITE BAR W/7 GRANITE SLIM CLEAR REDS
6. **VP142045** - **5GSCA** 63" SLEEPER PANEL W/5 GRANITE SLIM CLEAR AMBERS

# WINGMASTER ACCESSORIES

## PETERBILT MODEL 589

### FENDER GUARDS, AIR CLEANER LIGHT BARS, CAB & SLEEPER PANELS

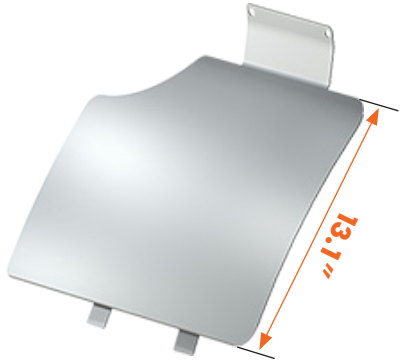

VP120020

PB BLIND MOUNT FENDER GUARD

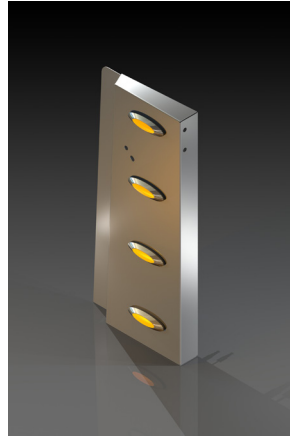

VP110420-4GSCA

PB HOOD EXTENSION  
W/4 GRANITE SLIM CLEAR AMBERS

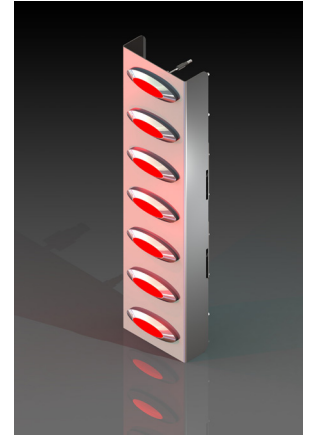

VP113120-7GSCR

PB REAR AIRCLEANER LITE BAR  
W/7 GRANITE SLIM CLEAR REDS

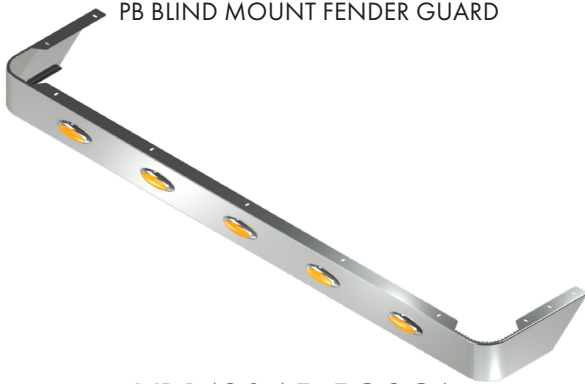

VP142045-5GSCA

PB 63" SLEEPER PANEL  
W/5 GRANITE SLIM CLEAR AMBERS



VP112121

PB FRONT AIRCLEANER LITE BAR  
(NO CUTOUTS)



VP112120-7GSCA

PB REAR AIRCLEANER LITE BAR  
W/7 GRANITE SLIM CLEAR AMBERS



VP110221-3GSCA

PB DRIVER-SIDE CAB PANEL  
W/3 GRANITE SLIM CLEAR AMBERS



VP110220

PB DRIVER-SIDE CAB PANEL  
(NO CUTOUTS)



VP110421

PB FACTORY HOOD PANEL REPLACEMENT

# WINGMASTER ACCESSORIES

## ACCESSORIES FOR ALL PETERBILT MODELS



**VP** Valley  
Chrome  
Plating  
**QUALITY TRUCK PARTS**

Bumpers and Stainless Accessories made in the USA



[www.valleychrome.com](http://www.valleychrome.com)

# WINGMASTER ACCESSORIES

## ALL PETERBILT MODELS

### HOOD EMBLEMS

PETERBILT LOGO EMBLEM NOT INCLUDED



VP100004  
EMBLEM ACCENT PB  
TEAR DROP - 2PC  
TAPE MOUNT



VP100005  
EMBLEM ACCENT PB  
TEAR DROP W/CUTOUTS - 2PC  
TAPE MOUNT



VP100006  
EMBLEM ACCENT PB  
ELLIPSE W/CUTOUT - PAIR  
INCLUDES MOUNTING HARDWARE



VP100007  
EMBLEM ACCENT PB  
SKULL & CROSSBONES - PAIR  
TAPE MOUNT



VP100008  
EMBLEM ACCENT PB  
CHECKERED FLAG - PAIR  
INCLUDES MOUNTING HARDWARE



VP100010  
EMBLEM ACCENT PB  
WILD FIRE - PAIR  
TAPE MOUNT



VP100011  
EMBLEM ACCENT PB  
FLAMES - 2PC  
INCLUDES MOUNTING HARDWARE



VP100013  
EMBLEM ACCENT PB  
OVAL - PAIR  
TAPE MOUNT



VP100012  
EMBLEM ACCENT PB  
CHEVRON - PAIR  
TAPE MOUNT

# WINGMASTER ACCESSORIES

## ALL PETERBILT MODELS

### HOOD EMBLEMS

PETERBILT LOGO EMBLEM NOT INCLUDED



**VP100014**  
EMBLEM ACCENT PB  
OVAL - W/CUTOUTS - PAIR  
INCLUDES MOUNTING  
HARDWARE



**VP100015**  
EMBLEM ACCENT PB  
OVAL - W/SPADES - PAIR  
TAPE MOUNT



**VP100016**  
EMBLEM ACCENT PB  
OVAL - W/2-EXTENSIONS - PAIR  
TAPE MOUNT



**VP100017**  
EMBLEM ACCENT PB  
OVAL - W/3-EXTENSIONS - PAIR  
TAPE MOUNT



**VP100018**  
EMBLEM ACCENT PB  
SWIRL - 2PC  
INCLUDES MOUNTING  
HARDWARE



**VP100027**  
EMBLEM ACCENT PB -  
FISH - PAIR  
INCLUDES MOUNTING  
HARDWARE



**VP100029**  
EMBLEM ACCENT PB -  
FLAMES - 2PCS.  
INCLUDES MOUNTING  
HARDWARE



**VP100019**  
EMBLEM ACCENT PB  
SWIRL - W/CUTOUTS - 2PC  
INCLUDES MOUNTING  
HARDWARE

### HOOD LATCH GUARDS



**VP100022**  
PB HOOD LATCH TRIM  
STANDARD HOOD - 2PC



**VP100024**  
PB HOOD LATCH TRIM  
EXTENDED HOOD - 2 PC



**VU190011**  
PB, FL, KW, HOOD LATCH  
ACCENT TRIM - PAIR

# WINGMASTER ACCESSORIES

## ALL PETERBILT MODELS

### KEY GUARDS

STRONG 3M DOUBLE-SIDED TAPE INCLUDED



VP110001  
PB KEY GUARD  
FLAME - PAIR



VP110002  
PB KEY GUARD  
TEAR DROP - PAIR



VP110003  
PB KEY GUARD  
CHECKERED FLAG - PAIR



VP110004  
PB KEY GUARD  
TRIANGLE - PAIR



VP110005  
PB KEY GUARD  
OVAL - PAIR



VP110006  
PB KEY GUARD  
ELLIPSE W/CUTOUT - PAIR



VP110007  
PB KEY GUARD  
WILDFIRE - PAIR



VP110008  
PB KEY GUARD - FISH

### MISC. TRIM PIECES

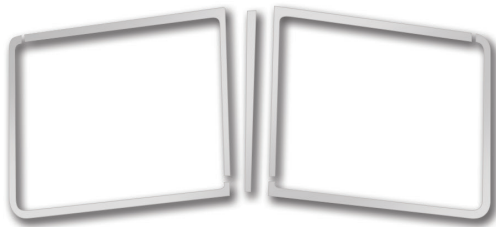

VP110014  
PB WINDSHIELD TRIM 3 PC



VP110021  
PB WINDSHIELD TRIM 5 PC

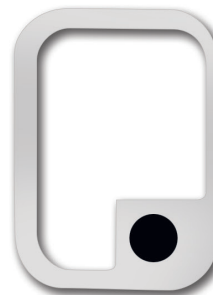

VP110011  
PB CAB MOUNTED MIRRORS  
DOOR LATCH/KEY HOLE  
COVERS - 2PC



# WINGMASTER ACCESSORIES

## ALL PETERBILT MODELS

### BUG SHIELD – MODEL 387



**VP120108**  
PB BUG SHIELD - STAINLESS  
PETE - 387  
MOUNTING HARDWARE INCLUDED

## WINDOW TRIM

MOUNTS WITH STRONG 3M DOUBLE-SIDED TAPE



**VP140001**  
PB RECTANGULAR  
VIEW WINDOW  
TRIM RING



**VP140002**  
PB 70" SLEEPER  
WINDOW TRIM - PAIR



**VP140003**  
PB SLEEPER/DAY CAB REAR  
WINDOW TRIM 37.25" X 20.375"



**VP140014**  
PB 70" SLEEPER WINDOW TRIM  
- LOWERED LOOK PR

## SLEEPER WINDOW LOWER LOOKS

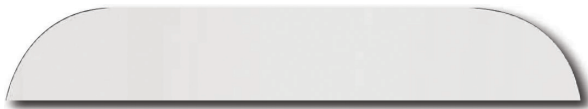

**VP140117**  
PB TOP OF DOOR TRIM - LOWERED LOOK - PR  
WILL ONLY FIT DOORS WITHOUT VENT WINDOW

ADD -P FOR PAINTABLE



# WINGMASTER ACCESSORIES

## PETERBILT SUN VISORS BY CAB TYPE

### STANDARD MOUNT STAINLESS VISORS

BRACKETS AND MOUNTING HARDWARE INCLUDED  
AVAILABLE IN 304 STAINLESS STEEL – CALL FOR PRICING



VP130000  
PB-14" - DROP VISOR 1996-98 ULTRA CAB



VP130001  
PB - 359 12" DROP VISOR - ANY YEAR 359

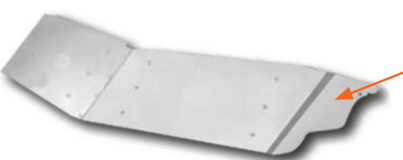

VP130002  
PB-14" - DROP VISOR - STANDARD CAB 2005 &  
OLDER WITH DOOR MOUNTED MIRRORS



VP130002-16  
PB - 16" - DROP VISOR - STANDARD CAB 2005 &  
OLDER, NOTE 04 AND OLDER DOOR MNT MIRRORS

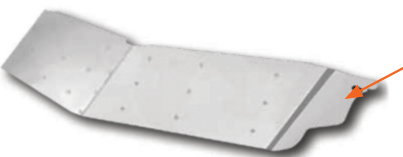

VP130003  
PB - 14" - DROP VISOR -  
1999-2001 ONLY, ULTRACAB



VP130003-16  
PB-16" - DROP VISOR 1999 - 2001 ULTRACAB



VP130004  
PB - 14" - DROP VISOR - 2002 - 2005 ULTRACAB  
WITH DOOR MOUNTED MIRRORS

VP130004-16  
PB - 16" - DROP VISOR - 2002 - 2005 ULTRACAB  
WITH DOOR MOUNTED MIRRORS

VP130005  
PB - 14" - DROP VISOR - 2005 - NEWER  
ULTRACAB - W/CAB MOUNTED MIRRORS

VP130005-16  
PB - 16" - DROP VISOR - 2005 - NEWER  
ULTRACAB W/CAB MOUNTED MIRRORS

VP130006  
PB - 13.5" - DROP VISOR - 2005 - NEWER  
STANDARD CAB W/CAB MOUNTED MIRRORS,  
ALSO FITS MODEL 348

VP130006-16  
PB - 16" - DROP VISOR - 2005 - NEWER  
STANDARD W/CAB MOUNTED MIRRORS  
ALSO FITS MODEL 348

VP130017  
PB-12"- DROP VISOR 2025-NEW



VP130005

**PAINTABLE  
VISORS  
AVAILABLE**

JUST ADD "P" TO THE END  
FOR PAINTABLE. EXAMPLE:

VP130002-P  
RAW 18 GAUGE STEEL

ADD LIGHTS TO YOUR VISOR – SEE PAGES 106-107 FOR LIGHT OPTIONS

# WINGMASTER ACCESSORIES

## PETERBILT SUN VISORS BY CAB TYPE

### BOLTLESS MOUNT STAINLESS VISORS

BRACKETS AND MOUNTING HARDWARE INCLUDED  
AVAILABLE IN 304 STAINLESS STEEL – CALL FOR PRICING



VP131002  
PB-14" - BOLTLESS - DROP VISOR - STANDARD  
CAB 2005 & OLDER -  
DOOR MOUNTED MIRRORS - 1 PC

VP131002-16  
PB-16" - BOLTLESS - DROP VISOR - STANDARD  
CAB 2005 & OLDER -  
DOOR MOUNTED MIRRORS - 1 PC



VP131003  
PB-14" - BOLTLESS - DROP VISOR -  
1999 - 2001 - ULTRACAB - 1 PC

VP131003-16  
PB-16" - BOLTLESS - DROP VISOR -  
1999 - 2001 - ULTRACAB - 1 PC



VP131004  
PB - 14" - BOLTLESS - DROP VISOR  
- 2002 - 2005 ULTRACAB WITH  
DOOR MOUNTED MIRRORS - 1 PC

VP131004-16  
PB - 16" - BOLTLESS - DROP VISOR  
- 2002 - 2005 ULTRACAB WITH  
DOOR MOUNTED MIRRORS - 1 PC



VP131005  
PB - 14" - BOLTLESS DROP VISOR  
2005 + ULTRACAB ONE PIECE W/CAB  
MT MIRRORS

VP131005-16  
PB - 16" - DROP VISOR 2005 + ULTRACAB ONE  
PIECE W/CAB MT MIRRORS



VP131006  
PB - 14" - BOLTLESS - DROP VISOR -  
2005 - NEWER STANDARD W/CAB  
MOUNTED MIRRORS - 1 PC

VP131006-16  
PB - 16" - BOLTLESS DROP VISOR -  
2005 - NEWER STANDARD W/CAB  
MOUNTED MIRRORS - 1 PC



VP130005

**COOL  
BOLTLESS  
LOOK!**

**PAINTABLE  
VISORS  
AVAILABLE**

JUST ADD "P" TO THE END  
FOR PAINTABLE. EXAMPLE:

VP131002-P  
RAW 18 GAUGE STEEL

ADD LIGHTS TO YOUR VISOR – SEE PAGES 106-107 FOR LIGHT OPTIONS

# WINGMASTER ACCESSORIES

## PETERBILT WICKED VISORS

### BOLTLESS STAINLESS VISORS

BRACKETS AND MOUNTING HARDWARE INCLUDED  
AVAILABLE IN 304 STAINLESS STEEL – CALL FOR PRICING



VP135000  
PB - 15" WICKED - DROP VISOR  
1996-98 ULTRA CAB - 2 PC

VP135001  
PB - 12" WICKED - DROP  
VISOR - ANY YEAR 359 - 2PC

VP135002  
PB - 15" WICKED - DROP  
VISOR - STANDARD CAB  
2005 & OLDER W/DOOR  
MOUNTED MIRRORS - 2 PC

VP135003  
PB - 15" WICKED - DROP  
VISOR 1999-2001 ULTRA  
CAB - 2PC

VP135004  
PB - 15" WICKED - DROP  
VISOR - 2002 - 2005  
ULTRACAB WITH DOOR  
MOUNTED MIRRORS - 2 PC

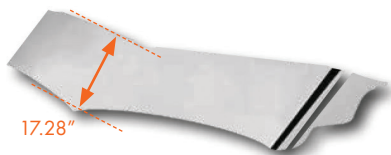

VP135005  
PB - 15" WICKED - DROP  
VISOR - 2005 - NEWER  
ULTRACAB W/CAB MOUNTED  
MIRRORS - 2 PC



VP135006  
PB - 15" WICKED - DROP  
VISOR - 2005 - NEWER  
STANDARD W/CAB  
MOUNTED MIRRORS - 2 PC



VP136002  
PB - 13" WICKED  
GANGSTER VISOR - FITS  
ANY - 370 SERIES & 380  
SERIES - 2 PC



VP135006

YOU SAY  
**WICKED**  
LIKE IT'S A BAD THING

**COOL  
BOLTLESS  
LOOK!**



ADD LIGHTS TO YOUR VISOR – SEE PAGES 106-107 FOR LIGHT OPTIONS

# WINGMASTER ACCESSORIES

## PETERBILT SUN VISORS

## GANGSTER STAINLESS VISORS

BRACKETS AND MOUNTING HARDWARE INCLUDED  
MADE WITH 16 GAUGE GRADE 430



**VP132002**  
PB - 12" GANGSTER VISOR - FITS ANY - 370 SERIES & 380 SERIES 2 PC WITH SPLIT WINDSHIELD



**VP132002-BF**  
PB - 12" GANGSTER BUTTERFLY VISOR - FITS ANY 370 SERIES & 380 SERIES 2 PC WITH SPLIT WINDSHIELD



**VP132002P-BF**  
PB - 12" GANGSTER BUTTERFLY VISOR PAINTABLE - FITS ANY 370 SERIES & 380 SERIES 2 PC WITH SPLIT WINDSHIELD



**VP132002-RBF**  
PB - 12" GANGSTER REVERSE BUTTERFLY VISOR - FITS ANY - 370 SERIES & 380 SERIES 2 PC WITH SPLIT WINDSHIELD



**VP132002P-RBF**  
PB - 12" GANGSTER REVERSE BUTTERFLY VISOR PAINTABLE - FITS ANY - 370 SERIES & 380 SERIES 2 PC WITH SPLIT WINDSHIELD



**VP132002-BT**  
PB - 12" GANGSTER BOWTIE VISOR - FITS ANY 370 SERIES & 380 SERIES 2 PC WITH SPLIT WINDSHIELD



**VP132002P-BT**  
PB - 12" GANGSTER BOWTIE VISOR PAINTABLE - FITS ANY 370 SERIES & 380 SERIES 2 PC WITH SPLIT WINDSHIELD



**VP132017**  
PB-14" - GANGSTER REVERSE BOWTIE VISOR - FITS ULTRA CAB



**VP132018**  
PB-14" - BOLTLESS - GANGSTER FLAT BOTTOM VISOR - FITS ULTRA CAB



VP132002P-BT shown



**PAINTABLE**  
**VISORS**  
**AVAILABLE**

JUST ADD "P" TO THE END  
FOR PAINTABLE

RAW 18 GAUGE STEEL  
COLORS SHOWN EXAMPLES ONLY

ADD LIGHTS TO YOUR VISOR – SEE PAGES 106-107 FOR LIGHT OPTIONS

# WINGMASTER ACCESSORIES

## PETERBILT STAINLESS TRIM

### SLEEPER WRAPS

#### MOUNTS WITH STRONG 3M DOUBLE-SIDED TAPE



VP140005  
PB SLEEPER WRAP -  
FLAG - LG



VP140007  
PB SLEEPER WRAP -  
FLAMES - LG



VP140009  
PB SLEEPER WRAP - STEER  
HEAD - LG



VP140006  
PB SLEEPER WRAP - FLAG -  
SM - UNIBILT STAND-UP



VP140008  
PB SLEEPER WRAP - FLAMES -  
SM - UNIBILT STAND-UP

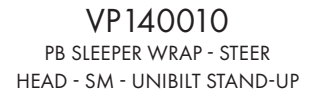

VP140010  
PB SLEEPER WRAP - STEER  
HEAD - SM - UNIBILT STAND-UP



VP140023  
PB SLEEPER WRAP -  
GIRLS - LG



VP140018  
PB SLEEPER WRAP -  
PLAIN - LG - FLAT TOP CAB

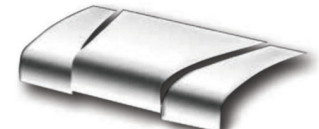

VP140011  
PB SLEEPER WRAP -  
PLAIN - LG - FLAT TOP - 3PC



VP140024  
PB SLEEPER WRAP - GIRLS -  
SM - UNIBILT STAND-UP



VP140019  
PB SLEEPER WRAP - PLAIN -  
SM - ULTRA CAB



VP140012  
PB SLEEPER WRAP - PLAIN -  
SM - 3PC - UNIBILT STAND-UP



VP140015  
PB SLEEPER WRAP - PLAIN -  
SM - SIDES - 2PCS



VP140016  
PB SLEEPER WRAP - PLAIN -  
LG - SIDES - 2PCS

### REAR FRAME COVERS

#### MOUNTS USING EXISTING FRAME BOLTS



VP160001  
PB - REAR FRAME COVER -  
379



VP160003  
PB - REAR FRAME COVER -  
WILDFIRE



VP160004  
PB - REAR FRAME COVER -  
ELLIPSE



VP160005  
PB - REAR FRAME COVER -  
OVAL - W/CUTOUTS

**WILL NOT WORK WITH  
ALUMINUM FRAMES**



VP160006  
PB - REAR FRAME COVER -  
STEER HEAD

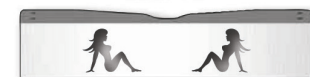

VP160007  
PB - REAR FRAME COVER -  
GIRLS

# WINGMASTER ACCESSORIES

## PETERBILT STAINLESS TRIM

### DEF TANK COVERS

MOUNTS TO EXISTING HARDWARE



VP150028  
DEF FUEL TANK COVER -  
STAINLESS



### FUEL TANK WRAPS

MOUNTS BEHIND FUEL TANK STRAPS  
STRONG 3M DOUBLE-SIDED TAPE ALSO INCLUDED



VP150041  
DRIVER SIDE  
PB -2012 FUEL TANK WRAP -  
75 GALLON

VP150041-PS  
PASSENGER SIDE  
PB -2012 FUEL TANK WRAP -  
75 GALLON

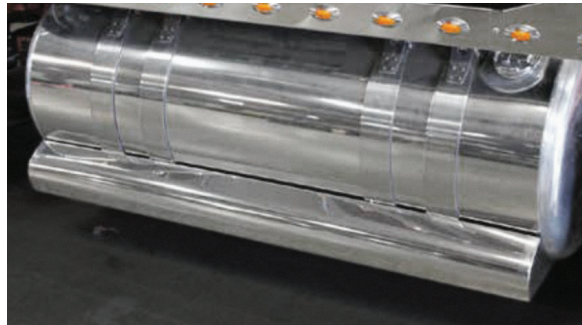

VP150040  
DRIVER SIDE  
PB - 2012 FUEL TANK WRAP -  
150 GALLON

VP150040-PS  
PASSENGER SIDE  
PB - 2012 FUEL TANK WRAP -  
150 GALLON

**SPECIFY TANK LENGTH, INSIDE WELD TO INSIDE WELD WHEN ORDERING**

# WINGMASTER ACCESSORIES

## KENWORTH W900



Bumpers and Stainless Accessories made in the USA



[www.valleychrome.com](http://www.valleychrome.com)



# WINGMASTER ACCESSORIES

## KENWORTH W900

### CAB PANELS

#### MOUNTING HARDWARE INCLUDED



VK110205  
W900L - 2014 - HIGHLIGHT -  
BLANK - 2 PCS



VK110206  
W900L - 2014 - HIGHLIGHT  
- BLANK - W/ LIGHT HOLE -  
HEATER PLUG HOLE



VK110200  
W900L - AEROCAB - CAB  
PANELS - 50.25" - BLANK

ADD LIGHTS TO YOUR PANEL – SEE PAGES 106-107

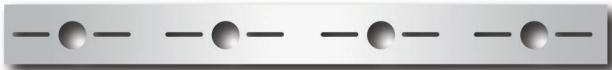

EXAMPLE  
VK110200-4UN



EXAMPLE  
VK110200-5RN

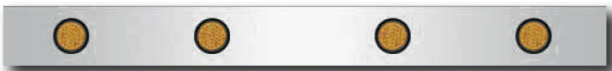

EXAMPLE  
VK110200-4RA



EXAMPLE  
VK110200-4GA



VK110200-3GA shown

# WINGMASTER ACCESSORIES

## KENWORTH W900

### SLEEPER PANELS

#### MOUNTING HARDWARE INCLUDED



##### VK142035

KW SLEEPER PANELS - T600  
(1995 & NEWER, NO FAIRINGS) T800  
(1986 & NEWER), W900  
(1986 & NEWER) - 42" - BLANK



##### VK142008

KW SLEEPER PANELS -  
AEROCAB - NO SIDE FAIRING -  
T600, T800, W900 - 60" - BLANK  
- 1995 & NEWER  
WRAPS ON BOTH ENDS



##### VK142015

KW SLEEPER PANELS -  
AEROCAB - NO SIDE FAIRING -  
T600, T800, W900 - 72" - BLANK



##### VK142023

KW SLEEPER PANELS -  
AEROCAB - NO SIDE FAIRING  
- T600, T800, W900 - 86" -  
BLANK



##### VK142030

KW SLEEPER PANELS -  
AEROCAB - NO SIDE FAIRING,  
PASS SIDE NOTCHED FOR EXH -  
T600, T800, W900 - 62" - BLANK



##### VK142100

KW SLEEPER PANELS -  
AEROCAB - W/EXHAUST -  
W900 L - 62" - BLANK



##### VK142101

KW SLEEPER PANELS -  
AEROCAB - W/EXHAUST  
- W900 L - 72" - BLANK



##### VK142105

KW SLEEPER PANELS -  
AEROCAB - W/FUEL DOOR -  
W900 L - 86" - BLANK



##### VK142200

KW SLEEPER PANELS - 2014  
AEROCAB - 62" - BLANK - 2 PCS

ADD LIGHTS TO YOUR PANEL - SEE PAGES 106-107



EXAMPLE  
VK142008-3UN



EXAMPLE  
VK142008-5RA



EXAMPLE  
VK142023-8GA

# WINGMASTER ACCESSORIES

## KENWORTH W900

### HOOD EXTENSION PANELS

MOUNTING HARDWARE INCLUDED



**VK110300**  
HOOD EXTENSION PANELS -  
W900L - BLANK - 1997-2004 -  
2 PCS



**VK110305**  
HOOD EXTENSION PANELS -  
W900L - BLANK - 2014 - 2 PCS

ADD LIGHTS TO YOUR PANEL – SEE PAGES 106-107



**EXAMPLE**  
VK110300-3UN



**EXAMPLE**  
VK110300-4GA



### SLEEPER EXTENSION PANELS

MOUNTING HARDWARE INCLUDED



**VK143001**  
SLEEPER EXTENSION PANELS  
- T600, T800, W900 - BLANK -  
1992 - 2012



**EXAMPLE**  
VK143001-1GA

# WINGMASTER ACCESSORIES

## KENWORTH W900

### AIR CLEANER LIGHT BOXES

MOUNTING HARDWARE INCLUDED



**VK113000**  
AIR CLEANER LIGHT BOXES -  
W900 - FRONT - BLANK



**VK113001**  
AIR CLEANER LIGHT  
BOXES - W900 - CENTER  
MOUNT - FRONT - BLANK



**VK110020**  
AIR CLEANER LIGHT BOXES -  
W900 - REAR - BLANK



**VK112209**  
KW - AIR CLEANER  
SUPPORT - BLANK -  
W900L - 2014 - PAIR

ADD LIGHTS TO YOUR PANEL – SEE PAGES 106-107

EXAMPLE:



**VK113000-8RA**  
AIR CLEANER LIGHT BOXES -  
W900 - FRONT - 8 ROUND AMBERS



# WINGMASTER ACCESSORIES

---

## KENWORTH W900

### AIR CLEANER FAIRINGS



VK100013  
AIR CLEANER FAIRING W9L PR



VK100020  
AIR CLEANER FAIRING W9L  
PR 2014



VK100022  
AIR CLEANER FAIRING W9L PAIR  
2014 - SLIM VERSION



# WINGMASTER ACCESSORIES

## KENWORTH W900

### EXTERIOR WINDOW TRIM

MOUNTS WITH STRONG 3M DOUBLE-SIDED TAPE



VK110021  
2014 KW WINDSHIELD  
TRIM - 4 PC - W900 CURVED  
WINDSHIELD

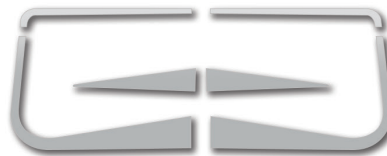

VK110018  
2014 KW WINDSHIELD TRIM  
- 6 PC - W900 - CURVED  
WINDSHIELD - LARGE

### EXHAUST SHIELDS

BRACKETS AND MOUNTING HARDWARE INCLUDED



VK110090  
KW EXHAUST SHIELD W/NO  
LOGO W900B



### BUG SHIELDS

MOUNTING HARDWARE INCLUDED



VK120023  
KW BUGSHIELD TRIM - W900L -  
HIGHLIGHT ONLY  
STAINLESS HIGHLIGHT



VK120024  
KW BUGSHIELD TRIM - W900L -  
FLAME - ONLY  
STAINLESS HIGHLIGHT



VK120009  
KW STAINLESS BUG SHIELD  
- 900L



VK120010  
KW STAINLESS BUG SHIELD  
- 900B

# WINGMASTER ACCESSORIES

## KENWORTH W900

### BLINKER BARS

RUBBER TRIM AND MOUNTING HARDWARE INCLUDED



VK120501  
KW - W900L FRONT BLINKER  
BARS W/LIGHTS



VK100501  
KW - W900L REAR BLINKER  
BARS W/LIGHTS



VK120501 BL  
KW - W900L FRONT BLINKER  
BARS BLANK

ADD LIGHTS TO YOUR BLINKER BAR – SEE PAGES 106-107



### FLAP WEIGHTS



VK190001  
2014 W900 L - FRONT FENDER  
FLAP WEIGHTS - 2 PCS

# WINGMASTER ACCESSORIES

## KENWORTH W900

### FENDER GUARDS



VK120019



VK120016  
KW - FENDER GUARDS -  
W900L - 1989 & NEWER - PAIR

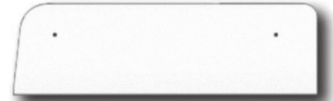

VK120017  
KW - FENDER GUARDS -  
W900L - FLUSH MOUNT  
1989 & NEWER - PAIR



VK120019  
KW - FENDER GUARDS -  
W900B - FLUSH MOUNT  
1989 & NEWER - PAIR

### BATTERY & TOOL BOX COVERS



VK150004  
KW - BATTERY BOX COVER -  
T600, T800, W900 - 39.5" X 9.0"



VK150005  
KW - BATTERY BOX COVER -  
T600, T800, W900 - 45" X 9"



VK150006  
KW - TOOL BOX COVER - T600,  
T800, W900 - 39.5" X 8.5"



VK150007  
KW - TOOL BOX COVER - T600,  
T800, W900 - 45" X 8.5"

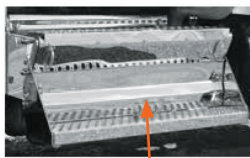

VK150030  
2014- W900 L - BATTERY BOX  
STEP COVER



VK150031  
2014- W900 L - BATTERY  
COVER HIGHLIGHT - 2 PCS



VK150032  
2014- W900 L - BATTERY BOX  
STEP HIGHLIGHT - 5 PCS



# WINGMASTER ACCESSORIES

## KENWORTH W900

### HOOD & GRILLE TRIM



VK120002  
W9L LOWER GRILL FILTER TRIM



VK120001  
W900L TOP GRILL  
DEFLECTORS - PAIR



11151  
HOOD WING -  
POWER STYLE



11191  
FENDER WINGS -  
POWERSTYLE



22281  
SIDE HOOD WINGS



VK120007  
KW SIDE GRILL DEFLECTOR -  
FULL LENGTH - W900L



VK120008  
KW SIDE GRILL DEFLECTOR -  
FOR USE WITH BLINKER BAR  
- W900L



VK120004  
KW SIDE GRILL DEFLECTORS



VK120008

# WINGMASTER ACCESSORIES

## KENWORTH W900

### STAINLESS SUN VISORS

#### MOUNTING HARDWARE INCLUDED



#### VK130001

VK-13" - DROP VISOR - W900  
AEROCAB CURVED - 1995 - 2006



VK130001



#### VK130002

KW - 13" - DROP VISOR - W900 - CABS W/  
SPLIT FLAT WINDSHIELDS 1984 TO 1998



VK130002



#### VK130003

KW - 11" - DROP VISOR - (W900 2007-2013)  
- (T660, T800 2007-2024)-  
CURVED WINDSHIELD



VK130003



#### VK130004

KW - 13" - DROP VISOR - W900 - CABS W/  
SPLIT FLAT WINDSHIELD 1999 TO 2004

#### VK131004

KW - 13" - DROP VISOR - W900 - CABS W/  
SPLIT FLAT WINDSHIELD 1999 TO 2004 - 1PC -  
BOLTLESS

# WINGMASTER ACCESSORIES

## KENWORTH W900

### GANGSTER VISORS

#### MOUNTING HARDWARE INCLUDED



VK132001

KW - 12" - GANGSTER VISOR - DROP  
- W900 - CURVED WINDSHIELD - 1995  
- 2006 - 2 PC

EXAMPLE



VK132003

KW - 12" - GANGSTER VISOR -  
DROP - W900, T660, T800 - CURVED  
WINDSHIELD - 2007 & NEWER - 2 PC

VK132001P

KW - 12" - GANGSTER VISOR  
PAINTABLE - DROP - W900 - CURVED  
WINDSHIELD - 1995 - 2006 - 2 PC  
RAW 18-GAUGE STEEL



VK132001-BF

KW - 12" - GANGSTER BUTTERFLY  
VISOR - DROP - W900 - CURVED  
WINDSHIELD - 1995 - 2006 - 2 PC

EXAMPLE



VK132001P-BF

KW - 12" - GANGSTER BUTTERFLY  
VISOR PAINTABLE - DROP - W900 -  
CURVED WINDSHIELD - 1995 - 2006 - 2 PC  
RAW 18-GAUGE STEEL

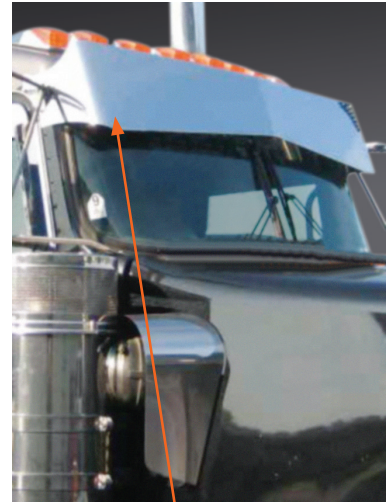

VK132003-BF



VK132003-BF

**ABOVE VISORS ARE  
ONLY AVAILABLE IN 12"**



ADD LIGHTS TO YOUR VISOR – SEE PAGES 106-107 FOR LIGHT OPTIONS

# WINGMASTER ACCESSORIES

## KENWORTH W900

### BOLTLESS WICKED VISORS

#### MOUNTING HARDWARE INCLUDED



VK135001  
KW - 13" - WICKED - DROP  
- W900 AEROCAB CURVED  
1995-2006 - 2 PIECE



VK135002  
KW - 13" - WICKED - DROP  
- W900 - CABS W/ SPLIT  
FLAT WINDSHIELDS 1984  
TO 1998 - 2 PIECE

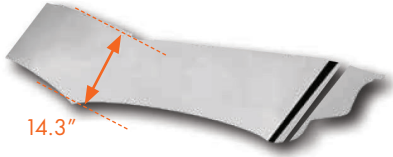

VK135003  
KW - 14" - WICKED -  
DROP - W900, T660, T800  
- CURVED WINDSHIELD -  
2007 & NEWER - 2 PIECE



VK135004  
KW - 13" - WICKED -  
DROP - W900 - CABS W/  
SPLIT FLAT WINDSHIELD  
1999 & NEWER - 2PIECE



VK136001  
KW - 14" - WICKED  
GANGSTER - W900 -  
CURVED WINDSHIELD -  
1995-2006 - 2 PIECE



VK136003  
KW - 14" - WICKED  
GANGSTER - W900,  
T660, T800 - CURVED  
WINDSHIELD -  
2007-NEWER - 2 PIECE

**PAINTABLE  
VISORS  
AVAILABLE**

JUST ADD "P" TO THE END  
FOR PAINTABLE. EXAMPLE:

VK135002-P  
RAW 18 GAUGE STEEL

**COOL  
BOLTLESS  
LOOK!**



VK135001

YOU SAY  
**WICKED**  
LIKE IT'S A BAD THING

ADD LIGHTS TO YOUR VISOR – SEE PAGES 106-107

# WINGMASTER ACCESSORIES

## KENWORTH W900

### CATALYTIC SYSTEM BOX HIGHLIGHT



VK150020  
2014- W900 L - CATALYTIC  
STEP COVER



VK150021  
2014- W900 L - CATALYTIC  
COVER HIGHLIGHT - 2 PCS



VK150022  
2014- W900 L - CATALYTIC  
STEP HIGHLIGHTS - 5 PCS

### DEF TANK COVER



VK150028  
KW - 2014 W900 L - DEF  
TANK COVER



### STAINLESS DECK PLATES



VK192010  
FRONT DECK PLATE FLUSH MOUNT - W/  
AIR LINE BOX CUTOUT - 2014 W900 L



VK192011  
MID DECK PLATE FLUSH MOUNT -  
2014 W900 L - 66"X27"









VK192012  
REAR DECK PLATE - FLUSH MOUNT -  
2014 W900 L

# WINGMASTER ACCESSORIES

## KENWORTH W900

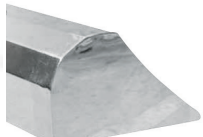
### FUEL TANK FAIRINGS

BRACKETS & MOUNTING HARDWARE INCLUDED  
 NOT AVAILABLE IN 430 STAINLESS  
 FAIRINGS FOR STANDARD WIDTH TANK STRAPS SHOWN

 <p>60"</p> <p><b>VK150001</b>              KW - FUEL TANK FAIRINGS 60"              - W900 - 1998 &amp; NEWER - PAIR</p>	 <p>66"</p> <p><b>VK150002</b>              KW - FUEL TANK FAIRINGS 66"              - W900 - 1998 &amp; NEWER - PAIR</p>	 <p>73"</p> <p><b>VK150003</b>              KW - FUEL TANK FAIRINGS              73" - W900 - 1998 &amp; NEWER - PAIR</p>	 <p>STANDARD</p>
 <p><b>VK150001R</b>              KW - FUEL TANK FAIRINGS              60" - ROUND - W900 - 1998 &amp;              NEWER</p>	 <p><b>VK150002R</b>              KW - FUEL TANK FAIRINGS 14"              66" - ROUND - W900 - 1998 &amp;              NEWER</p>	 <p><b>VK150003R</b>              KW - FUEL TANK FAIRINGS              73" - ROUND - W900 - 1998 &amp;              NEWER</p>	 <p>ROUNDED</p>



ADD LIGHTS TO YOUR FAIRING – SEE PAGES 106-107



# WINGMASTER ACCESSORIES

---

## KENWORTH W900

### LOWER HOOD PANELS

KENWORTH LOGO NOT INCLUDED



VK100016

KW - LOWER HOOD PANELS -  
W900 1989 & NEWER - PR

### CENTER HOOD TRIM



VK100021

KW - W900L CENTER  
HOOD TRIM  
TAPE MOUNT

# WINGMASTER ACCESSORIES

## KENWORTH T600



Photo submitted by Tony St Bernard

Bumpers and Stainless Accessories made in the USA



[www.valleychrome.com](http://www.valleychrome.com)



# WINGMASTER ACCESSORIES

## KENWORTH T600

### SLEEPER PANELS



**VK142035**  
KW SLEEPER PANELS - T600  
(1995 & NEWER, NO FAIRINGS) T800  
( 1986 & NEWER ), W900  
(1986 & NEWER ) - 42" - BLANK



**VK142008**  
KW SLEEPER PANELS -  
AEROCAB - NO SIDE FAIRING -  
T600, T800, W900 - 60" - BLANK  
- 1995 & NEWER



**VK142015**  
KW SLEEPER PANELS -  
AEROCAB - NO SIDE FAIRING -  
T600, T800, W900 - 72" - BLANK



**VK142023**  
KW SLEEPER PANELS -  
AEROCAB - NO SIDE FAIRING  
- T600, T800, W900 - 86" -  
BLANK



**VK142030**  
KW SLEEPER PANELS -  
AEROCAB - NO SIDE FAIRING  
, PASS SIDE NOTCHED FOR  
EXH - T600, T800, W900 - 62"  
- BLANK

ADD LIGHTS TO YOUR PANEL – SEE PAGES 106-107



EXAMPLE  
VK142008-3UN



EXAMPLE  
VK142008-5RA



EXAMPLE  
VK142023-8GA

### SLEEPER EXTENSION PANELS

#### MOUNTING HARDWARE INCLUDED



**VK143001**  
SLEEPER EXTENSION PANELS  
- T600, T800, W900 - BLANK -  
1992 - 2012



EXAMPLE  
VK143001-1GA

# WINGMASTER ACCESSORIES

---

## KENWORTH T600

### STAINLESS GRILLES

MOUNTING HARDWARE INCLUDED



VK120600  
KW GRILL T600B -  
HORIZONTAL - RIVETED

### BUG SHIELDS

MOUNTING HARDWARE INCLUDED



VK120012  
KW STAINLESS BUG SHIELD  
- T600



---

**QUALITY TRUCK PARTS**

# WINGMASTER ACCESSORIES

## KENWORTH T600

### BATTERY & TOOL BOX COVERS



VK150004

KW - BATTERY BOX COVER -  
T600, T800, W900 - 39.5" X 9.0"



VK150005

KW - BATTERY BOX COVER -  
T600, T800, W900 - 45" X 9"



VK150006

KW - TOOL BOX COVER -  
T600, T800, W900 - 39.5" X 8.5"



VK150007

KW - TOOL BOX COVER - T600, T800,  
W900 - 45" X 8.5"

### SIDE MARKER TRIM



VK140001

T600 SIDE MARKER LIGHT  
ACCENT TRIM - PAIR



**QUALITY TRUCK PARTS**

**WINGMASTER ACCESSORIES**

**KENWORTH T660**



Bumpers and Stainless Accessories made in the USA



[www.valleychrome.com](http://www.valleychrome.com)

# WINGMASTER ACCESSORIES

## KENWORTH T660

### CAB PANELS

MOUNTING HARDWARE INCLUDED



VK110201  
T660 - CAB PANELS - BLANK"

ADD LIGHTS TO YOUR PANEL – SEE PAGES 106-107

### BUG SHIELDS

MOUNTING HARDWARE INCLUDED



VK120015  
KW STAINLESS BUG SHIELD  
- T660



### STAINLESS SUN VISORS

MOUNTING HARDWARE INCLUDED

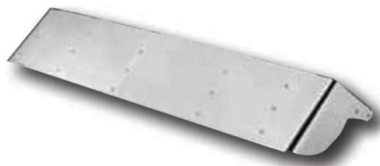

VK130003  
KW - 13" - DROP VISOR - (W900 2007-2013)  
- (T660, T800 2007-2015)-  
CURVED WINDSHIELD

VK131003  
KW - 13" - DROP VISOR - W900 - T660 -  
CURVED WINDSHIELD - 2007 & NEWER - 1PC  
- BOLTLESS

# WINGMASTER ACCESSORIES

## KENWORTH T660

### GANGSTER VISORS

#### MOUNTING HARDWARE INCLUDED

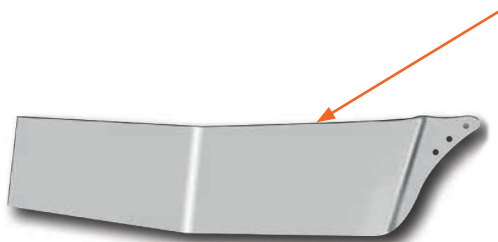

#### VK132003

KW - 12" - GANGSTER VISOR  
DROP - W900, T660, T800 - CURVED  
WINDSHIELD - 2007 & NEWER - 2 PC

#### VK132003 - BF

KW - 12" - GANGSTER VISOR - BUTTERFLY  
DROP - W900, T660, T800 - CURVED  
WINDSHIELD - 2007 & NEWER - 2 PC



VK132003-BF

**ABOVE VISORS ARE  
ONLY AVAILABLE IN 12"**

### BOLTLESS WICKED VISORS

#### MOUNTING HARDWARE INCLUDED

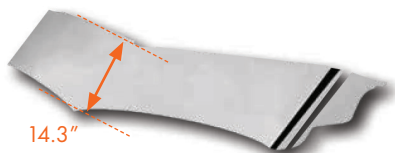

14.3"

#### VK135003

KW - 14" - WICKED -  
DROP - W900, T660, T800  
- CURVED WINDSHIELD -  
2007 & NEWER - 2 PIECE



#### VK136003

KW - 14" - WICKED  
GANGSTER - W900,  
T660, T800 - CURVED  
WINDSHIELD -  
2007-NEWER - 2 PIECE

**COOL  
BOLTLESS  
LOOK!**

YOU SAY  
**WICKED**  
LIKE IT'S A BAD THING

# WINGMASTER ACCESSORIES

---

## **KENWORTH T660**

### **BATTERY & TOOL BOX COVERS**



VK150008  
T660 DAY CAB BATTERY BOX  
HIGHLIGHT

# WINGMASTER ACCESSORIES

## KENWORTH T680



- 1** VK110028 Top of door trim – “lowered” look
- 2** VK110209 Cab Panel – Blank (VK110209-3GA shown)
- 3** VK150029 DEF Tank Cover
- 4** VK120101 Bug shield
- 5** VK130007 12” drop visor
- 6** FV-0010-708 Chrome front bumper (other options available)

Bumpers and Stainless Accessories made in the USA



[www.valleychrome.com](http://www.valleychrome.com)



# WINGMASTER ACCESSORIES

## KENWORTH T680

### CAB & COWEL PANELS

#### MOUNTING HARDWARE INCLUDED



**VK110209**  
2015 T680 - CAB PANELS - BLANK"  
VERTICAL EXHAUST ONLY



**VK110210**  
2016 T680 - CAB PANELS - BLANK



**VK110211**  
2016 T680 - CAB PANELS - BLANK  
W/HEATER PLUG HOLE

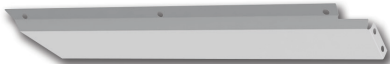

**VK110210**  
(ALTERNATE VIEW)



**VK110308**  
2021-2023 COWEL PANEL  
(FITS HIGH-ROOF TRUCKS)



**VK110308-4GSCA**  
2021-2023 COWEL PANEL  
W/4 GRANITE SLIM CLEAR AMBER LIGHTS  
(FITS HIGH-ROOF TRUCKS)

ADD LIGHTS TO YOUR PANEL – SEE PAGES 106-107

### SLEEPER EXTENSION PANELS

#### MOUNTING HARDWARE INCLUDED



**VK143001**  
SLEEPER EXTENSION PANELS  
- T600, T800, W900 - BLANK -  
1992 - 2012

### DOOR AND WINDOW TRIM



**VK110222**  
KW - T680 DOOR ENTRY KICK  
PANELS - 4PCS UPPER &  
LOWER



**VK110028**  
KW T680 LOWERED LOOK - 2015

# WINGMASTER ACCESSORIES

## KENWORTH T680

### BUG SHIELDS

MOUNTING HARDWARE INCLUDED



VK120101  
KW STAINLESS BUG SHIELD - T680



VK120104  
KW STAINLESS BUG SHIELD  
- T680  
(FITS TRUCKS W/O HOOD MIRRORS)

### FENDER GUARDS



VK120018  
KW - T680 FENDER GUARDS  
- FITTED - 4PCS. UPPER &  
LOWER

### STAINLESS SUN VISORS



VK130007  
KW - 13" - DROP - T680, T880 -  
CURVED WINDSHIELD - 2015  
REPLACES FACTORY VISOR ONLY

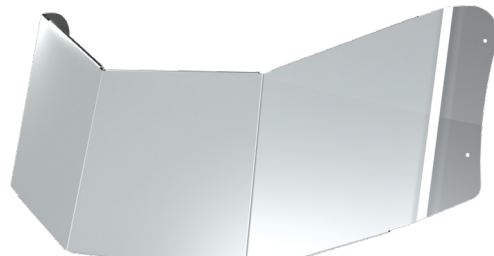

VK130008  
KW - 15" DROP VISOR T680  
MID-ROOF STANDUP SLEEPER  
WITH NO EXISTING FACTORY VISOR

# WINGMASTER ACCESSORIES

---

## KENWORTH T680

### DEF TANK COVER

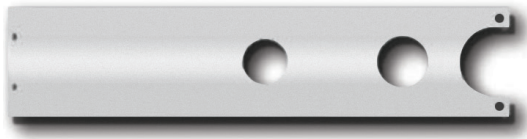

VK150029  
KW - UREA TANK COVER 2015  
T680

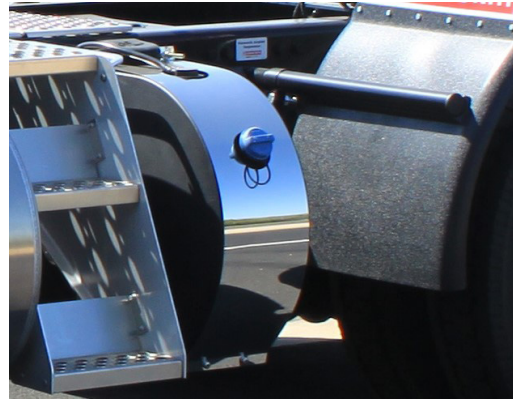

# WINGMASTER ACCESSORIES

## KENWORTH T800 & T880



Bumpers and Stainless Accessories made in the USA



[www.valleychrome.com](http://www.valleychrome.com)

# WINGMASTER ACCESSORIES

## KENWORTH T800 & T880

### SLEEPER PANELS

#### MOUNTING HARDWARE INCLUDED



**VK142035**

KW SLEEPER PANELS - T600  
(1995 & NEWER, NO FAIRINGS) T800  
(1986 & NEWER), W900  
(1986 & NEWER) - 42" - BLANK



**VK142008**

KW SLEEPER PANELS -  
AEROCAB - NO SIDE FAIRING -  
T600, T800, W900 - 60" - BLANK  
- 1995 & NEWER



**VK142015**

KW SLEEPER PANELS -  
AEROCAB - NO SIDE FAIRING -  
T600, T800, W900 - 72" - BLANK



**VK142023**

KW SLEEPER PANELS -  
AEROCAB - NO SIDE FAIRING  
- T600, T800, W900 - 86" -  
BLANK

ADD LIGHTS TO YOUR PANEL – SEE PAGES 106-107



EXAMPLE

VK142008-3UN



EXAMPLE

VK142008-5RA



EXAMPLE

VK142023-8GA

### SLEEPER EXTENSION PANELS

#### MOUNTING HARDWARE INCLUDED



**VK143001**

SLEEPER EXTENSION PANELS  
- T600, T800, W900 - BLANK -  
1992 - 2012



EXAMPLE

VK143001-1GA

# WINGMASTER ACCESSORIES

## KENWORTH T800 & T880

### BUG SHIELDS

MOUNTING HARDWARE INCLUDED



VK120013  
KW STAINLESS BUG SHIELD  
- T800

### FENDER GUARDS



VK120022  
KW - FENDER GUARDS - T-800  
AERO CAB - 1996 & NEWER - PAIR

### STAINLESS SUN VISORS



VK130003  
KW - 13" - DROP VISOR - (W900 2007-2013) - (T660,  
T800 2007-2015)- CURVED WINDSHIELD  
MOUNTING HARDWARE INCLUDED

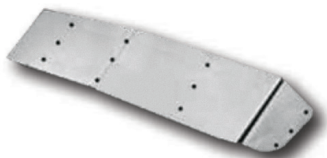

VK130007  
KW - 13" - DROP - T680, T880 -  
CURVED WINDSHIELD - 2015  
DAY CAB ONLY  
NO MOUNTING HARDWARE INCLUDED  
REPLACES FACTORY VISOR ONLY

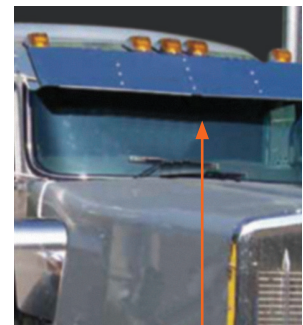

VK130003

# WINGMASTER ACCESSORIES

## KENWORTH T800 & T880

### GANGSTER VISORS

#### MOUNTING HARDWARE INCLUDED

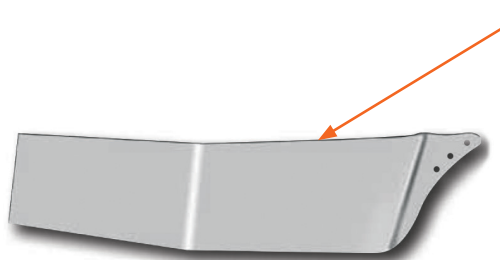

**VK132003**  
KW - 12" - GANGSTER VISOR -  
DROP - W900, T660, T800 - CURVED  
WINDSHIELD - 2007 & NEWER - 2 PC

**VK132003 - BF**  
KW - 12" - GANGSTER VISOR -  
DROP - W900, T660, T800 - CURVED  
WINDSHIELD - 2007 & NEWER - 2 PC



VK132003-BF

**ABOVE VISORS ARE  
ONLY AVAILABLE IN 12"**

### BOLTLESS WICKED VISORS

#### MOUNTING HARDWARE INCLUDED

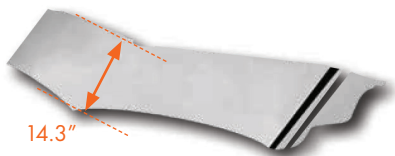

14.3"

**VK135003**  
KW - 14" - WICKED -  
DROP - W900, T660, T800  
- CURVED WINDSHIELD -  
2007 & NEWER - 2 PIECE

**COOL  
BOLTLESS  
LOOK!**



**VK136003**  
KW - 14" - WICKED  
GANGSTER - W900,  
T660, T800 - CURVED  
WINDSHIELD -  
2007-NEWER - 2 PIECE

YOU SAY  
**WICKED**  
LIKE IT'S A BAD THING

ADD LIGHTS TO YOUR VISOR – SEE PAGES 106-107

# WINGMASTER ACCESSORIES

---

## KENWORTH T800 & T880

### BATTERY & TOOL BOX COVERS

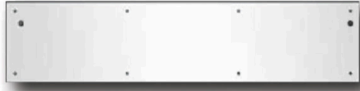

**VK150004**  
KW - BATTERY BOX COVER -  
T600, T800, W900 - 39.5" X 9.0"



**VK150005**  
KW - BATTERY BOX COVER -  
T600, T800, W900 - 45" X 9"



**VK150006**  
KW - TOOL BOX COVER - T600,  
T800, W900 - 39.5" X 8.5"



**VK150007**  
KW - TOOL BOX COVER - T600, T800,  
W900 - 45" X 8.5"



---

**QUALITY TRUCK PARTS**



# WINGMASTER ACCESSORIES

## ALL KENWORTH MODELS

### EXTERIOR WINDOW TRIM

MOUNTS WITH STRONG 3M DOUBLE-SIDED TAPE



VK110002  
KW DAYLIGHT DOOR OUTER  
TRIM - 6PC



VK110012  
KW EXTERIOR WINDOW TRIM  
- PASSENGER DOOR VIEW -  
DAYLIGHT DOOR



VK110013  
KW EXTERIOR WINDOW TRIM  
PASSENGER DOOR VIEW

### DOOR HANDLE TRIM



VK110003  
PB, KW STAINLESS DOOR  
HANDLE TRIM - PAIR

### LOWER LOOK



VK110017  
KW WINDOW LOWERED LOOK 4.5"  
FITS DAYLIGHT DOOR ONLY

### AIR DEFLECTORS



VK110001  
T300 T600 T800 W900  
WINDOW AIR DEFLECTORS PAIR

# WINGMASTER ACCESSORIES

## ALL KENWORTH MODELS

### EMBLEM ACCENTS

KENWORTH LOGO NOT INCLUDED



VK100001  
EMBLEM ACCENT  
OLD GLORY - PAIR  
TAPE MOUNT



VK100002  
EMBLEM ACCENT  
3 POINT SLOTTED - PAIR  
HARDWARE INCLUDED -PAIR



VK100003  
EMBLEM ACCENT  
FLAMES - PAIR  
TAPE MOUNT



VK100004  
EMBLEM ACCENT  
HIGH LIGHT - PAIR  
HARDWARE INCLUDED



VK100005  
EMBLEM ACCENT  
3 POINT - PAIR  
HARDWARE INCLUDED



VK100006  
EMBLEM ACCENT  
SATURN - PAIR  
HARDWARE INCLUDED



VK100007  
EMBLEM ACCENT  
SHORT SATURN - PAIR  
HARDWARE INCLUDED



VK100008  
EMBLEM ACCENT  
3-D LOOK - PAIR  
HARDWARE INCLUDED



VK100009  
EMBLEM ACCENT  
VICTORY LANE - PAIR  
HARDWARE INCLUDED



VK100012  
EMBLEM ACCENT  
U SHAPED UNDERLINE  
HARDWARE INCLUDED



VK100015  
EMBLEM ACCENT  
OVAL W/ UPWARD FLAME  
TAPE MOUNT

### HOOD LATCH GUARDS



VK100017  
KW - HOOD LATCH GUARDS  
T222, T800, W900 1989 &  
NEWER - PAIR



VK100018  
KW - HOOD LATCH GUARDS  
ALL MODELS W/ BALL LATCH  
1968 - 1989 - PAIR



VU190011  
PB, FL, KW, HOOD LATCH  
ACCENT TRIM - PAIR

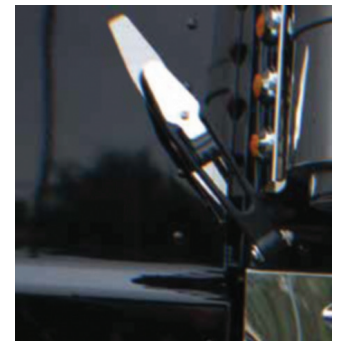

# WINGMASTER ACCESSORIES

## ALL KENWORTH MODELS

### SLEEPER WINDOW TRIM



VK140002  
W9L SLEEPER  
WINDOW TRIM - PAIR



VK140003  
KW 72" SLEEPER  
UPPER WINDOW TRIM  
(SLIDING OR SWING) PAIR



VK140004  
KW 86" STUDIO SLEEPER UPPER  
SLIDING WINDOW TRIM PAIR

### REAR FRAME COVERS



VK160001  
KW - REAR FRAME COVER -  
1992 & NEWER



VK160002  
KW - REAR FRAME COVER -  
STEER HEAD - 1992 & NEWER

### STAINLESS FUEL TANK WRAPS



VK150040  
KW - 2014 FUEL TANK -  
HYDRAULIC TANK COMBO  
WRAP - 72"



VK150041  
KW - 2014 FUEL TANK WRAP -  
75 GALLON - 57"



# WINGMASTER ACCESSORIES

## FREIGHTLINER FLD/CLASSIC



Bumpers and Stainless Accessories made in the USA



[www.valleychrome.com](http://www.valleychrome.com)

# WINGMASTER ACCESSORIES

## FREIGHTLINER FLD / CLASSIC

### CAB PANELS 4"

MOUNTING HARDWARE INCLUDED



**VF110015**  
FL - CAB PANEL - BLANK -  
PAIR - 1991 NEWER CLASSIC

ADD LIGHTS TO YOUR PANEL - SEE PAGES 106-107



**EXAMPLE**  
VF110015-3UN



**EXAMPLE**  
VF110015-4GA

### SLEEPER PANELS

MOUNTING HARDWARE INCLUDED



**VF142003**  
2001 CLASSIC XL INTEGRAL SLEEPER NO AERO  
WINGS - 48" SLEEPER PANELS - PAIR- BLANK

# WINGMASTER ACCESSORIES

## FREIGHTLINER FLD / CLASSIC

### HOOD LATCH GUARDS



**VF100001**  
FL - HOOD LATCH GUARDS -  
CLASSIC 1993 & NEWER - PAIR



**VF100005**  
FL - HOOD LATCH GUARDS -  
CLASSIC X L -  
1993 & NEWER - PAIR



**VU190011**  
PB, FL, KW, HOOD LATCH  
ACCENT TRIM - PAIR

### HOOD TRIM



**VF100010**  
FL CLASSIC FRONT SIDE OF HOOD  
TRIM W/ FLAMES PAIR



**VF100011**  
FL - LOWER HOOD PANELS -  
CLASSIC X L - 1993 & NEWER - PAIR

### LOWERED LOOK WINDOW PANELS



**VF110018**  
FLD & CLASSIC 5.75" LOWERED  
LOOK WINDOW PANELS

# WINGMASTER ACCESSORIES

## FREIGHTLINER FLD / CLASSIC

### MISC. TRIM PIECES



**VF110013**  
FL- DOOR LATCH TRIM -  
CENTURY / COLUMBIA /  
CLASSIC FLD - PAIR



**VF114001**  
FREIGHTLINER CLASSIC - HOOD  
EXTENSION PANEL - LAY-OVER - PAIR

### AIR CLEANER LIGHT BOXES



**VF112001**  
FL - CLASSIC - FRONT - AIR  
CLEANER LIGHT BOXES -  
BLANK - PAIR

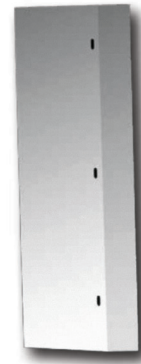

**VF113001**  
FL - CLASSIC - REAR - AIR  
CLEANER LIGHT BOXES -  
BLANK - PAIR

ADD LIGHTS TO YOUR LIGHT BOX – SEE PAGES 106-107

# WINGMASTER ACCESSORIES

## FREIGHTLINER FLD / CLASSIC

### FENDER GUARDS



**VF120003**  
FL CLASSIC & X L UPPER  
FENDER GUARDS (SHORT &  
LONG HOOD) PAIR



**VF120004**  
FL - FENDER GUARDS -  
EXTENDED HOOD - CLASSIC  
- 1993 & NEWER - PAIR



**VF120007**  
FL - FENDER GUARDS - FLD  
120 - 1989 & NEWER

### STAINLESS TRIM FOR PLASTIC BUMPERS



**VF120001**  
FLD SETBACK AXLE  
BUMPER TRIM KIT  
W/ 1 TOW PIN & FOG LIGHT  
HOLES 3 PC

ALSO CHECK OUT OUR  
EXTENSIVE LINE OF FULL METAL  
REPLACEMENT BUMPERS:  
CLASSIC, PAGES 11-13  
FLD SETBACKS, PAGES 15-18





# WINGMASTER ACCESSORIES

## FREIGHTLINER FLD / CLASSIC

### BUG SHIELDS

RUBBER TRIM & MOUNTING HARDWARE INCLUDED



VF120010  
FL - BUG SHIELD - STAINLESS  
- CLASSIC & CLASSIC XL



VF120011  
FL - BUG SHIELD - STAINLESS  
- FLD 120



**QUALITY TRUCK PARTS**

# WINGMASTER ACCESSORIES

## FREIGHTLINER FLD / CLASSIC

### SUN VISORS



VF130001

FL - 18" DROP VISOR - CLASSIC RAISED  
ROOF CONDO - 9 - 2" ROUND -  
NO LIGHTS INCLUDED



VF130002

FL - 18" DROP VISOR - CLASSIC MID ROOF -  
9 - 2" RD - NO LIGHTS INCLUDED



VF130006

FL-13" - DROP VISOR - CLASSIC XL FLAT  
TOP - REPLACES FACTORY STAINLESS ONLY -  
DOES NOT REPLACE FIBERGLASS.  
DOES NOT WORK WITH TRUCKS WITHOUT EXISTING VISOR.

**PAINTABLE  
VISORS  
AVAILABLE**

JUST ADD "P" TO THE END  
FOR PAINTABLE. EXAMPLE:

VF130001P  
RAW 18 GAUGE STEEL

ADD LIGHTS TO YOUR VISOR – SEE PAGES 106-107



**QUALITY TRUCK PARTS**

# WINGMASTER ACCESSORIES

## FREIGHTLINER FLD / CLASSIC

### WICKED BOLTLESS VISORS



VF135001

FL - 18" - WICKED - DROP  
VISOR - CLASSIC RAISED  
ROOF CONDO - 9 - 2" ROUND -  
NO LIGHTS INCLUDED - 2 PC

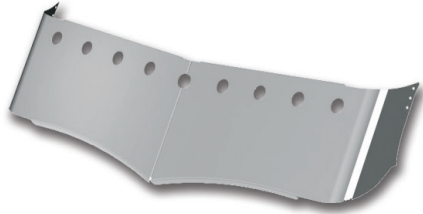

VF135002

FL - 18" - WICKED - DROP  
VISOR - CLASSIC MID-ROOF -  
9 - 2" RD - NO LIGHTS INCLUDED -  
2 PC



VF135006

FL - 13" - WICKED - DROP  
VISOR - CLASSIC XL - FLAT  
TOP UP TO 2001 REPLACES  
STAINLESS FACTORY VISOR - 2 PC

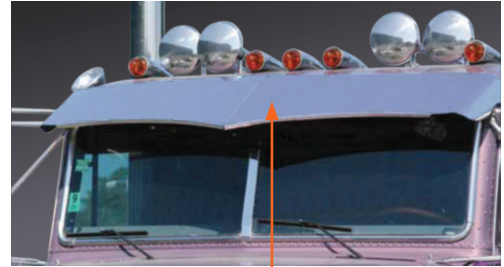

VF135006

YOU SAY  
**WICKED**  
LIKE IT'S A BAD THING

**COOL  
BOLTLESS  
LOOK!**

ADD LIGHTS TO YOUR VISOR – SEE PAGES 106-107



**WINGMASTER ACCESSORIES**

**FREIGHTLINER CENTURY & COLUMBIA**



Bumpers and Stainless Accessories made in the USA



[www.valleychrome.com](http://www.valleychrome.com)

# WINGMASTER ACCESSORIES

## FREIGHTLINER CENTURY & COLUMBIA

### CAB PANELS 4"

MOUNTING HARDWARE INCLUDED

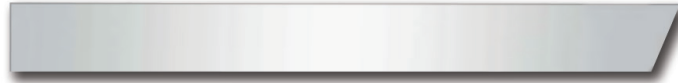

VF110020

FL - CAB PANEL - 4" - 2005  
AND NEWER CENTURY/COLUMBIA

ADD LIGHTS TO YOUR PANEL – SEE PAGES 106-107

### SLEEPER PANELS



VF140020

2005 AND NEWER CENTURY/  
COLUMBIA SLEEPER PANEL +  
EXTENSION - 1PC - 70" - BLANK

### MISC. TRIM PIECES

MOUNTS WITH STRONG 3M DOUBLE-SIDED TAPE



VF110013

FL- DOOR LATCH TRIM -  
CENTURY / COLUMBIA /  
CLASSIC FLD - PAIR



VF110014

FL - VIEW WINDOW TRIM RING  
- CENTURY / COLUMBIA



VF110019

FL - CENTURY / COLUMBIA UPPER CAB  
HIGHLIGHT - 2PCS

# WINGMASTER ACCESSORIES

## FREIGHTLINER CENTURY & COLUMBIA

### STAINLESS TRIM FOR PLASTIC BUMPERS



**VF120002**  
FL CENTURY PLASTIC BUMPER TRIM  
03-OLDER - 3 PC  
TAPE MOUNT

ALSO CHECK OUT OUR  
EXTENSIVE LINE OF FULL METAL  
REPLACEMENT BUMPERS:  
CENTURY, PAGES 19-20  
COLUMBIA, PAGES 19-20



### BUG SHIELDS

RUBBER TRIM & MOUNTING HARDWARE INCLUDED



**VF120013**  
FL - BUG SHIELD - STAINLESS  
- CENTURY



**VF120014**  
FL - BUG SHIELD - STAINLESS  
- COLUMBIA



# WINGMASTER ACCESSORIES

## FREIGHTLINER CENTURY & COLUMBIA

### SUN VISORS

BRACKETS AND MOUNTING HARDWARE INCLUDED  
AVAILABLE IN 304 STAINLESS STEEL – CALL FOR PRICING



#### VF130003

FL-18" - DROP VISOR - RAISED ROOF  
CENTURY - 2003 & OLDER - 10 - 2" ROUND -  
HOLES - NO LIGHTS INCLUDED ALSO FITS 2009 &  
OLDER CORONADO



#### VF130007

FL-18" DROP VISOR - RAISED ROOF CENTURY  
& COLUMBIA - 2004 & NEWER - 10 - 2" RD  
HOLES - NO LIGHTS INCLUDED



#### VF130014

FL - 14" DROP VISOR - 04  
CORONADO DAY CAB 06 -  
NEWER & COLUMBIA- NO LIGHTS  
ONLY FOR TRUCKS WITHOUT EXISTING FACTORY VISOR

#### VF130016

FL - 16" DROP VISOR - 04  
CENTURY/05 COLUMBIA MID  
ROOF - NO LIGHTS

**PAINTABLE  
VISORS  
AVAILABLE**

JUST ADD "P" TO THE END  
FOR PAINTABLE. EXAMPLE:

**VF130003P**  
RAW 18 GAUGE STEEL

ADD LIGHTS TO YOUR VISOR – SEE PAGES 106-107

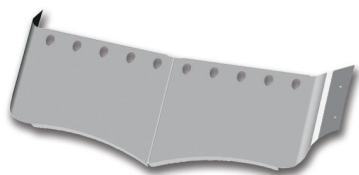

#### VF135003

FL - 18" - WICKED - DROP  
VISOR - CENTURY-RAISED  
ROOF - UP TO 2003 - 2 PC

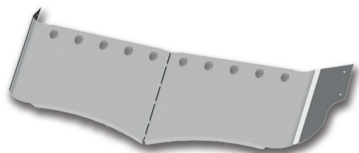

#### VF135007

FL- 18" - WICKED - DROP VISOR  
- CENTURY & COLUMBIA 2004 -  
NEWER - 2 PC - 10 2" ROUND HOLES  
NO LIGHTS INCLUDED



#### VF135016

FL - 16" WICKED - DROP VISOR -  
04 CENTURY/05 COLUMBIA MID  
ROOF - NO LIGHTS

YOU SAY  
**WICKED**  
LIKE IT'S A BAD THING

**COOL  
BOLTLESS  
LOOK!**

**WINGMASTER ACCESSORIES**

**FREIGHTLINER CORONADO 2002-2009  
& GLIDER KITS**



Bumpers and Stainless Accessories made in the USA



[www.valleychrome.com](http://www.valleychrome.com)



# WINGMASTER ACCESSORIES

## FREIGHTLINER CORONADO 2002-2009/GLIDERS

### BUG SHIELDS

RUBBER TRIM & MOUNTING HARDWARE INCLUDED



**VF120012**  
FL - BUG SHIELD - STAINLESS  
- CORONADO



### SUN VISORS

BRACKETS AND MOUNTING HARDWARE INCLUDED  
AVAILABLE IN 304 STAINLESS STEEL – CALL FOR PRICING

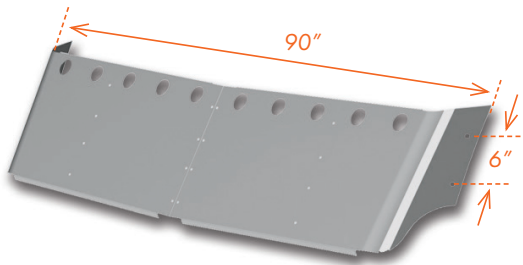

#### VF130003

FL-18" - DROP VISOR - RAISED ROOF  
CENTURY - 2003 & OLDER - 10 - 2" ROUND -  
HOLES - NO LIGHTS INCLUDED ALSO FITS 2009 &  
OLDER CORONADO



#### VF130014

FL - 14" DROP VISOR - 04  
CORONADO DAY CAB 06 -  
NEWER & COLUMBIA- NO LIGHTS

ADD LIGHTS TO YOUR VISOR – SEE PAGES 106-107

**WINGMASTER ACCESSORIES**

**FREIGHTLINER CASCADIA 2017  
& OLDER "P3"**



Bumpers and Stainless Accessories made in the USA



[www.valleychrome.com](http://www.valleychrome.com)

# WINGMASTER ACCESSORIES

## FREIGHTLINER CASCADIA 2017 & OLDER "P3"

### CAB PANELS 4"

MOUNTING HARDWARE INCLUDED

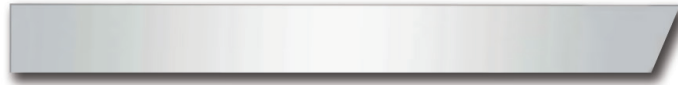

VF110200  
CAB PANEL 4" - CASCADIA -  
BLANK PAIR

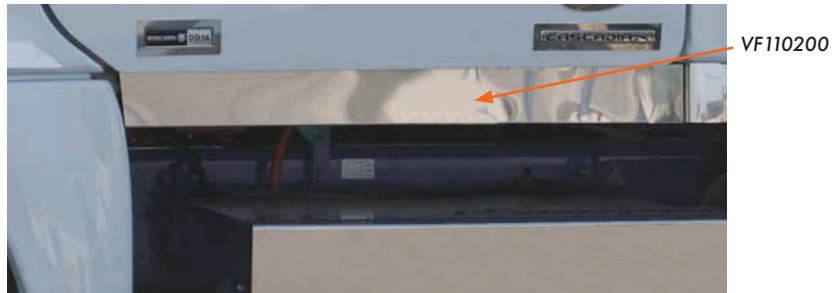

ADD LIGHTS TO YOUR PANEL – SEE PAGES 106-107

### SLEEPER PANELS

MOUNTING HARDWARE INCLUDED



VF140010  
CASCADIA SLEEPER PANEL 48"



VF142101  
FL SLEEPER EXTENSION PANEL -  
CASCADIA - 48" - BLANK



# WINGMASTER ACCESSORIES

## FREIGHTLINER CASCADIA 2017 & OLDER "P3"

### FAIRING PANELS

MOUNTS WITH STRONG 3M DOUBLE-SIDED TAPE

MID FAIRING KIT:



**VF142009**

2008 CASCADIA MID FAIRING  
PANELS - 6 PCS - BLANK

LOWER FAIRING KIT:

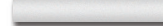

**VF142012**

2008 CASCADIA LOWER FAIRING  
PANELS - 6 PCS - BLANK

UNDER FAIRING KIT:



**VF142014**

2008 CASCADIA MID FAIRING  
PANELS - 6 PCS - BLANK

UNDER FAIRING INDIVIDUAL PIECES:



**VF142014-1**

2008 CASCADIA UNDER  
FAIRING PANEL -  
FRONT PASS SIDE



**VF142014-2**

2008 CASCADIA UNDER  
FAIRING PANEL - MIDDLE  
PASS SIDE



**VF142014-3**

2008 CASCADIA UNDER  
FAIRING PANEL - REAR  
PASS SIDE



**VF142014-4**

2008 CASCADIA UNDER  
FAIRING PANEL - FRONT  
DRIVERS SIDE



**VF142014-5**

2008 CASCADIA UNDER  
FAIRING PANEL - MIDDLE  
DRIVERS SIDE



**VF142014-6**

2008 CASCADIA UNDER  
FAIRING PANEL - REAR  
DRIVERS SIDE



Mid Fairing

Lower Fairing

Under Fairing

# WINGMASTER ACCESSORIES

## FREIGHTLINER CASCADIA 2017 & OLDER "P3"

### FENDER TRIM

MOUNTS WITH STRONG 3M DOUBLE-SIDED TAPE



VF100012

FL - CASCADIA FENDER TRIM - 2PC



VF100013

FL - CASCADIA FENDER TRIM EXT. - 2PC

### HOOD & DOOR TRIM

MOUNTS WITH STRONG 3M DOUBLE-SIDED TAPE

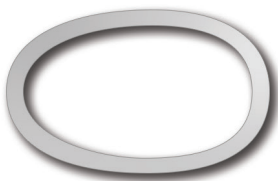

VF100016

FL - HOOD LIGHT TRIM - PAIR



VF100015

FL - CASCADIA AIR VENT ACCENT



VF110016

CASCADIA DOOR  
HANDLE TRIM

### LOWERED LOOK WINDOW PANELS

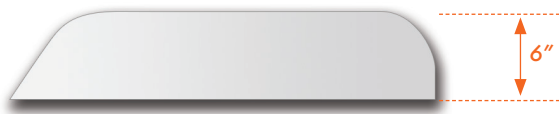

VF110017

CASCADIA LOWERED LOOK  
WINDOW PANELS

ALSO FITS 2018 & NEWER P4 MODEL CASCADIAS

# WINGMASTER ACCESSORIES

## FREIGHTLINER CASCADIA 2017 & OLDER "P3"

### STAINLESS TRIM FOR PLASTIC BUMPERS



VF120017  
CASCADIA FENDER TRIM -  
ABOVE BUMPER - PAIR



VF120006  
CASCADIA FT BUMPER TRIM  
- 4PC - TAPE MOUNT



VF120017

VF120006

ALSO CHECK OUT OUR EXTENSIVE  
LINE OF FULL METAL CASCADIA  
REPLACEMENT BUMPERS:  
PAGE 21-22



## BUG SHIELDS

RUBBER TRIM & MOUNTING HARDWARE INCLUDED



VF120015  
FL - BUG SHIELD - STAINLESS  
- CASCADIA



# WINGMASTER ACCESSORIES

## FREIGHTLINER CASCADIA 2017 & OLDER "P3"

### SUN VISORS

BRACKETS AND MOUNTING HARDWARE INCLUDED  
AVAILABLE IN 304 STAINLESS STEEL – CALL FOR PRICING



**VF130017**

FL - 18" STD MOUNT DROP VISOR  
CASCADIA "P3" YRS. 2017 OLDER  
CONDO/MID SLEEPER  
FOR TRUCKS WITH OR WITHOUT FACTORY VISOR



**PAINTABLE  
VISORS  
AVAILABLE**

JUST ADD "P" TO THE END  
FOR PAINTABLE. EXAMPLE:

**VF130017-P**  
RAW 18 GAUGE STEEL

ADD LIGHTS TO YOUR VISOR – SEE PAGES 106-107



**VF135017**

FL - 18" WICKED DROP VISOR - 2PC  
CASCADIA "P3" YRS. 2017 & OLDER  
CASCADIA "P4" YRS. 2018 & NEWER  
CONDO, MID ROOF  
REPLACES FACTORY VISOR

**COOL  
BOLTLESS  
LOOK!**



**VF130017BF**

FL - 18" STD MOUNT BUTTERFLY VISOR  
CASCADIA "P3" YRS. 2017 & OLDER  
CONDO, MID ROOF  
FOR TRUCKS WITH OR WITHOUT FACTORY VISOR

# WINGMASTER ACCESSORIES

## FREIGHTLINER CASCADIA 2017 & OLDER "P3"

### FUEL TANK COVERS

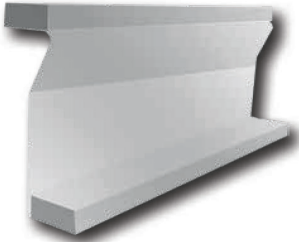

**VF150006**  
FL - CASCADIA FUEL TANK  
COVER W/STEPS - PASS SIDE

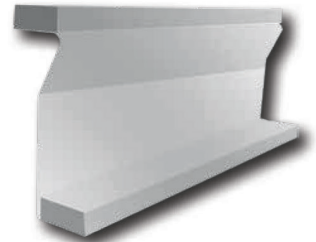
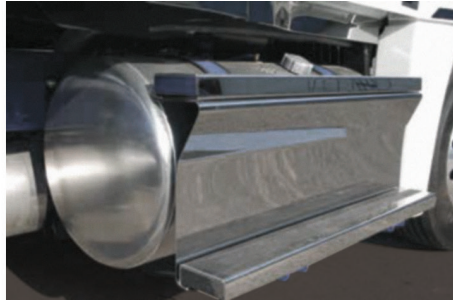

**VF150007**  
FL - CASCADIA BATTERY BOX/  
FUEL TANK COVER - 2011 DAY  
CAB 34"

### BATTERY BOX COVERS & STEPS



**VF150000**  
FL - CASCADIA BATTERY  
BOX COVER

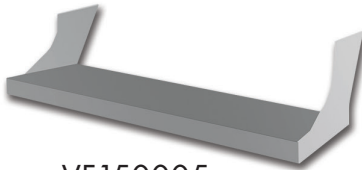

**VF150005**  
FL - CASCADIA UNDER  
BATTERY BOX STEP- 3PC.

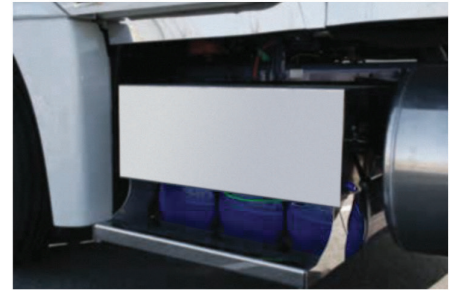

**VF150010**  
FL - CASCADIA BATTERY BOX  
UPPER - 2011 DAY CAB 34"



**VF150011**  
FL - CASCADIA BATTERY BOX  
UPPER - 2011 DAY CAB 40"

### CATALYTIC COVERS

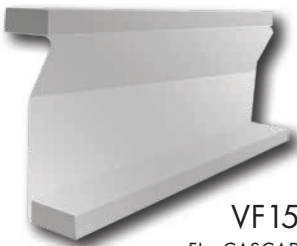

**VF150008**  
FL - CASCADIA CATALYTIC  
COVER - LOWER 2011 DAY  
CAB 40"



**VF150009**  
FL - CASCADIA CATALYTIC  
COVER - UPPER 2011 DAY  
CAB 40"



# WINGMASTER ACCESSORIES

## FREIGHTLINER ACCESSORIES - ALL MODELS

### EMBLEM ACCENTS



**VF100002**  
FL - EMBLEM ACCENTS -  
W/ CUTOUTS - PAIR  
INCLUDES MOUNTING HARDWARE



**VF100004**  
FL - EMBLEM ACCENTS -  
16" - PAIR  
TAPE MOUNT

### PERMIT PANELS



**VF110007**  
FL - PERMIT PANEL - EMBLEM  
& CUTOUT - LEFT -  
1998 & NEWER



**VF110008**  
FL - PERMIT PANEL - PLUG  
CUTOUT - LEFT -  
1998 & NEWER



**VF110009**  
FL - PERMIT PANEL - EMBLEM  
CUTOUT - LEFT -  
1998 & NEWER



**VF110010**  
FL - PERMIT PANEL - BLANK -  
LEFT - 1998 & NEWER



**VF110011**  
FL - PERMIT PANEL - EMBLEM  
CUTOUT - RIGHT -  
1998 & NEWER



**VF110012**  
FL - PERMIT PANEL - BLANK -  
RIGHT - 1998 & NEWER

### FUEL TANK FAIRING

**BRACKETS AND MOUNTING HARDWARE INCLUDED  
NOT AVAILABLE IN 430 STAINLESS**



**VF150001**  
FL - FUEL TANK FAIRINGS -  
82" - PAIR



**VF150002**  
FL - FUEL TANK FAIRINGS -  
87" - PAIR

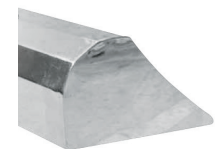

**WINGMASTER ACCESSORIES**

**INTERNATIONAL**



Bumpers and Stainless Accessories made in the USA



[www.valleychrome.com](http://www.valleychrome.com)

# WINGMASTER ACCESSORIES

## INTERNATIONAL



**VI130003**

INTL - 12" DROP VISOR 2PC  
FITS PROSTAR & LONESTAR



**VI135003**

INTL - 12" TAPERED TO 16" IN CENTER  
WICKED DROP VISOR - 2PC  
FITS PROSTAR & LONESTAR



VI135003-10BYCA

ADD LIGHTS TO YOUR VISOR OR PANEL – SEE PAGES 106-107

**VI120107**

INTL - BUG SHIELD FITS MODEL 9900  
STAINLESS STEEL  
RUBBER TRIM & MOUNTING HARDWARE INCLUDED



**VI110200**

INTL - CAB PANELS - FITS MODELS 9200,9300,9400  
STAINLESS STEEL



# WINGMASTER ACCESSORIES

## VOLVO VNL



Bumpers and Stainless Accessories made in the USA



[www.valleychrome.com](http://www.valleychrome.com)

# WINGMASTER ACCESSORIES

## VOLVO VNL

### HOOD & FENDER TRIM



VV120002  
FENDER GUARD - UPPER -  
780 SERIES  
TAPE MOUNT



VV100003  
FENDER GUARD - UPPER -  
780 SERIES  
TAPE MOUNT



## BUG SHIELD

### MOUNTING HARDWARE INCLUDED



VV120107  
BUG DEFLECTOR 630, 670, 780,  
830, 880 SERIES

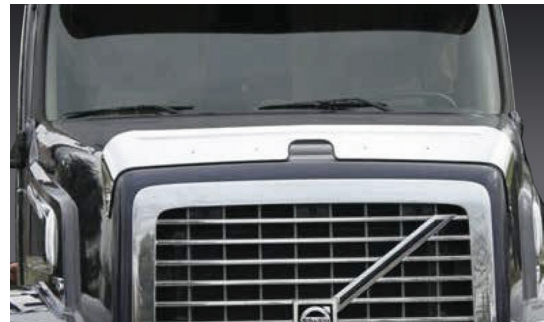

## STAINLESS TRIM FOR FACTORY VISORS



VV130000  
VISOR INSERT - 700, 800  
SERIES



# WINGMASTER ACCESSORIES

## VOLVO VNL

### FAIRING HIGHLIGHTS

MOUNTS WITH STRONG 3M DOUBLE-SIDED TAPE



VV121000  
FRONT FAIRING UPPER  
STEP PANEL - PAIR



VV121001  
FRONT FAIRING UPPER  
STEP HIGHLIGHT  
2PCS



VV121002  
FRONT FAIRING LOWER  
STEP PANEL - PAIR



VV121003  
FRONT FAIRING LOWER  
STEP HIGHLIGHT



VV121004  
FRONT FAIRING LOWER  
STEP BOTTOM HIGHLIGHT



VV121005  
REAR FAIRING UPPER  
STEP HIGHLIGHT

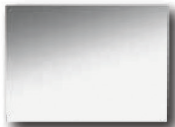

VV121006  
REAR FAIRING LOWER  
STEP PANEL



VV121007  
REAR FAIRING LOWER  
STEP HIGHLIGHT



VV121008  
REAR FAIRING LOWER  
STEP BOTTOM HIGHLIGHT



**WINGMASTER ACCESSORIES**

**VOLVO VT SERIES**



Bumpers and Stainless Accessories made in the USA



[www.valleychrome.com](http://www.valleychrome.com)

# WINGMASTER ACCESSORIES

## VOLVO VT SERIES

### CAB PANELS

#### MOUNTING HARDWARE INCLUDED



VV112000  
CAB PANELS 880/830 - BLANK  
- NO SIDE FAIRING



EXAMPLE  
VV112000-4GA

ADD LIGHTS TO YOUR PANEL – SEE PAGES 106-107

### SLEEPER PANELS

#### MOUNTING HARDWARE INCLUDED



VV143000  
SLEEPER PANELS - BLANK -  
WITH NO SIDE FAIRINGS



EXAMPLE  
VV143000 - 5UN



EXAMPLE  
VV143000- 5RN



EXAMPLE  
VV143000 - 7RA



EXAMPLE  
VV143000 - 4GA



# WINGMASTER ACCESSORIES

## VOLVO VT SERIES

### HOOD EXTENSION PANELS

MOUNTING HARDWARE INCLUDED



VV110300  
HOOD EXTENSION PANEL  
- BLANK



EXAMPLE  
VV110300-4GA

ADD LIGHTS TO YOUR PANEL – SEE PAGES 106-107

### HOOD & FENDER TRIM



VV100000  
HEADLIGHT TRIM - SIDE -  
830, 880 SERIES  
TAPE MOUNT



VV100001  
TOP FENDER TRIM - 830,  
880 SERIES  
TAPE MOUNT



# WINGMASTER ACCESSORIES

## VOLVO VT SERIES

### HOOD & FENDER TRIM

MOUNTS WITH STRONG 3M DOUBLE-SIDED TAPE



VV120000  
FENDER GUARD - UPPER -  
830, 880 SERIES



VV120001  
FENDER GUARD - LOWER -  
830, 880 SERIES

### BUG SHIELD

MOUNTING HARDWARE INCLUDED



VV120107  
BUG DEFLECTOR 630, 670,780,  
830, 880 SERIES



### SUN VISORS

MOUNTING HARDWARE INCLUDED



VV130005  
DROP VISOR - 830 MID-ROOF



# WINGMASTER ACCESSORIES

## VOLVO VT SERIES

### BATTERY BOX COVER

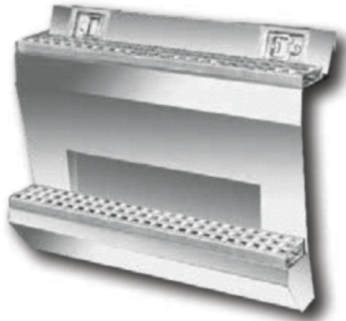

VV150000  
BATTERY BOX COVER - 830  
VOLVO - 8PCS



### FUEL TANK FAIRINGS



VV150001  
FUEL TANK FAIRINGS - 68"

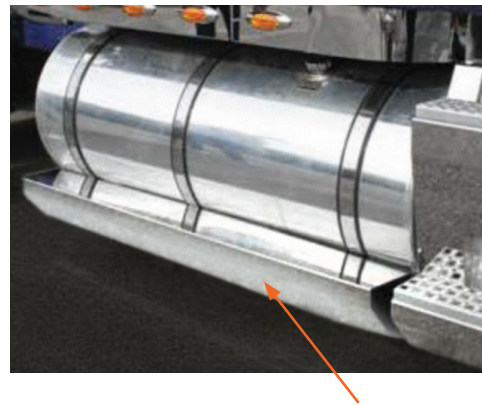

# WINGMASTER ACCESSORIES

## WESTERN STAR 4700SF

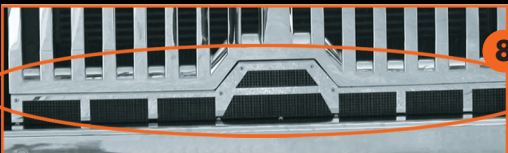

### PARTS LIST:

- 1** IM-2110-06 Chrome Bumper (Call for Options & Price)
- 2** VW120005 Fender Guards (Fitted)
- 3** VW120006 Upper Fender Guards (Rolled)
- 4** VW110200-8GMA Cab Panel Line  
(Cab Panels with Granite Amber Lights Shown)
- VW110200 Blank Cab Panels w/Heater  
Plug Holes (Not Pictured)
- VW110201 Blank Cab Panels (Not Pictured)
- 5** VW130001 12" Visor - 2013 & Newer
- 6** VW120010 Bug Shield - Stainless Steel
- 7** VW120011 Bug Shield - Stainless Steel - "W" Look
- 8** VW120201 Lower Radiator Rock Guard

Bumpers and Stainless Accessories made in the USA



[www.valleychrome.com](http://www.valleychrome.com)

# WINGMASTER ACCESSORIES

## WESTERN STAR 4700SF YEARS 2013 & NEWER CAB PANELS MOUNTING HARDWARE INCLUDED



VW110200  
WS CAB PANELS - 2013 AND  
NEWER - 4700 SF - BLANK W/  
HEATER PLUG HOLE



VW110201  
CAB PANELS - BLANK - NO  
SIDE FAIRING - 4PCS

ADD LIGHTS TO YOUR PANEL – SEE PAGES 106-107

## FENDER GUARDS



VW120005  
WS FENDER GUARDS - FITTED -  
4700 SF 2013 AND NEWER  
HARDWARE INCLUDED

VW120006  
WS UPPER FENDER GUARD  
- FITTED 4700 SF 2013  
AND NEWER  
TAPE MOUNT

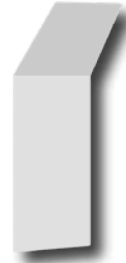

## WESTERN STAR 49X SETBACK AXLE YEARS 2021 & NEWER PANELS



VW110202  
CAB PANELS - BLANK  
(FITS TRUCKS WITH CAB MOUNTED EXHAUST)



VW142000  
60" SLEEPER PANEL - BLANK  
(FITS TRUCKS WITH CAB MOUNTED EXHAUST)

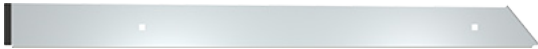

VW110203  
COWEL PANEL

# WINGMASTER ACCESSORIES

## WESTERN STAR 4700SF YEARS 2013 & NEWER BUG SHIELDS

BRACKETS & MOUNTING HARDWARE INCLUDED



VW120010  
PB BUG SHIELD - STAINLESS  
- 4700 SF 2013 AND NEWER



VW120011  
WS BUG SHIELD - "W" STYLE  
- STAINLESS - 4700 SF 2013  
AND NEWER

## RADIATOR ROCK GUARD

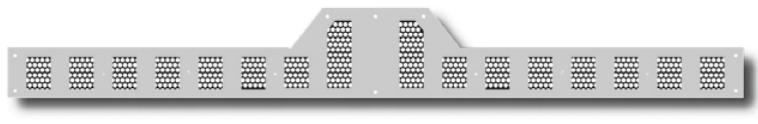

VW120201  
WS LOWER RADIATOR  
GUARD - 2013 AND NEWER  
4700 SF

## SUN VISORS BRACKETS & MOUNTING HARDWARE INCLUDED



VW130001  
WS 12" VISOR 2013 AND NEWER 4700  
SF



## 5700XE YEARS 2015 & NEWER SUN VISORS

BRACKETS & MOUNTING HARDWARE INCLUDED

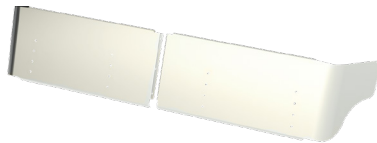

VW130002  
WS SUNVISOR - 13.5" WIDE  
5700XE STAINLESS

ADD LIGHTS TO YOUR VISOR – SEE PAGES 106-107

For more info on bumpers for this model, see page 85

## BUG SHIELDS MOUNTING HARDWARE INCLUDED



VW120014  
WS BUGSHIELD  
5700XE STAINLESS



# WINGMASTER ACCESSORIES

## 47X/49X SETBACK AXLE YEARS 2021-NEWER VISORS



VW130003  
12" DROP VISOR



VW130004  
15" DROP VISOR



VW130004  
15" DROP VISOR  
(REAR VIEW)



## 49X SETBACK AXLE YEARS 2022-NEWER SLEEPER EXTENSION PANEL



VW142100  
SLEEPER EXTENSION PANEL  
ISO VIEW



VW142100  
SLEEPER EXTENSION PANEL

## 49X SETBACK AXLE YEARS 2022-NEWER AIR INTAKE SCREEN

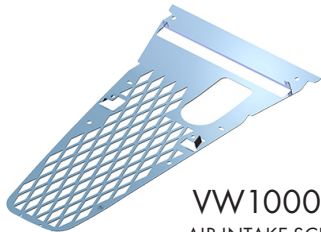

VW100000  
AIR INTAKE SCREEN  
ISO VIEW

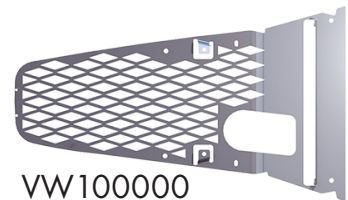

VW100000  
AIR INTAKE SCREEN

**THE ORIGINAL  
TURBOWING  
BY  
WINGMASTER  
A DIVISION OF VALLEY CHROME PLATING**





# WINGMASTER ACCESSORIES

## TURBOWING



## THE TURBOWING ADVANTAGE

“The Original Turbowing” is the Grand-Daddy of all air deflectors. This size, shape and design is today’s air deflector of choice and will be for another 30 years. Impeccable over the road performance records make it one of the most popular accessories in the industry today, because Turbowing works. Proven efficiency saves truckers thousands of dollars in fuel costs each year. Get started today!

### DURABILITY:

Turbowing “Tough” is the term unmatched in the trucking industry today. A rugged over-the-road environment remains a real-life “Tell-tale” test for big rig accessories. Some air deflectors are giving in to this harsh reality, Turbowings remain solid and continue to prove their worth, trip after trip!

### FUNCTIONAL:

Testimonials from owner operators have shown consistent fuel savings of approximately **10% up to 19%**. for the average owner/operator, this means payback for their Turbowing investment in less than six months.

## EXAMINE THIS LIST OF FEATURES OFFERED ONLY BY WINGMASTER COMPANY:

- Highest quality materials and hardware.
- Pre-formed body panels to reduce undue stress on rivets.
- Sleeper specific brackets attach to the strongest points of the sleeper at the factory-built supports.
- Fixed angle brackets ensure the correct angle for deflection of air, no fooling around.
- Full application range to fit all popular sleeper sizes in flat-top and raised roofs.
- Paccar approved, one of the only wing-styled air deflectors available through Paccar’s parts division.
- Tested and proven so you gain every time.

# WINGMASTER ACCESSORIES

## TURBOWING

### PICKUP TRUCK WINGS

#### HIGHLIGHTS OF THE WINGMASTER LINE OF AIR DEFLECTORS

- 30% reduction in drag.
- Wings are available in mirror polished stainless steel.
- Reduced "bug splatter" on the front of the trailer.
- Enhances stability in windy situations.
- Increased towing speed.
- The ability to pass other large vehicles without getting bogged down or blown around from on-coming wind.
- No drilling required with easy on and off clip mount system. (For most full size domestic pickup trucks 3/4 ton and up)

#### DESIGNED TO IMPROVE YOUR TOW PACKAGE

Towing a 5th wheel trailer, gooseneck race car trailer with a pickup truck or big rig semi truck means you are fighting the wind. Wingmaster builds a stylish wing to deflect air over the trailer and maximize fuel economy every time you tow.

Going camping? Want to get better fuel mileage towing on the way to and from your destination but just want the most economical way to save fuel? Use Wingmaster air deflectors.

#### TURBOWING UNIVERSAL CLIP-ON/BOLT-ON WING

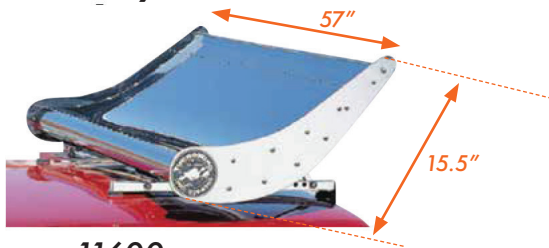

**11600**

DODGE, CHEVY, FORD - POWER  
\*SEE UNIVERSAL MOUNTING KITS

#### HIGH PROFILE UPGRADE KIT



**11603**

11600 UPGRADE KIT, MINI WING,  
END PLATES, BOLT KITS

APPLICATION	CAB STYLE	CLIP-ON KIT	BOLT-ON KIT
2001 - 2006 Chevy & GMC (2500-3500)	Extended w/4-door	10244	11703
2001 - 2006 Chevy & GMC (2500-3500)	Extended w/ small door	10244	11703
2001 - 2006 Chevy & GMC (2500-3500)	Crew cab	10249	11704
2007 & Newer Chevy & GMC (2500-3500)	Extended cab	17249	11703
2007 & Newer Chevy & GMC (2500-3500)	Crew cab	17249	11704
2010-2014 Chevy	Crew cab	10258	(N/A)
2015 Chevy	Crew cab	10256	(N/A)
1980 - 1997 Ford	All cabs w/rain gutters	11230	CALL
1998 & Newer Ford Standard,	Extended w/4-door, Crew	10237	10601
2015 Ford 3/4 ton to 1 ton	Super Crew	10257	(N/A)
1994-2002 Dodge (1500-3500)	All cabs	10251	(N/A)
2003-2010 Dodge	All cabs	10252	11706
2013 & Newer Dodge	All cabs	10254	(N/A)

# WINGMASTER ACCESSORIES

## TURBOWING

### AEROLIGHT 700 SERIES



- 38" Rail
- 76" L X 26" D X 20" H
- Ideal size and function for all stand-up high-roof sleepers
- Downsized, identical design/function as the Turbowing 1.
- Conforms to industry height restrictions.
- Preset wing angle for optimum performance.
- Polished stainless bracketry.
- Polished stainless available for most standups.



## 900 SERIES

The Turbowing 900 Series was originally developed for the lower roof flat-top style sleepers where the height of the trailer was significantly taller than the roof of the truck. This design boasts bold, sharp looks, and works extremely well at increasing fuel mileage.

### Standard 900 Series

- Weight 125 lbs.
- 76" L X 30" D X 30" H
- Wing body: mirror polished stainless
- Brackets: polished stainless steel
- Adjustment: preset per sleeper/trailer height
- Fuel mileage increase: approx. 10%
- Drag/wing resistance reduction: 30%
- For most flat-top sleepers
- Warranty: 3 year limited



# WINGMASTER ACCESSORIES

## TURBOWING

### PETERBILT WINGS



**711**  
HIGH ROOF/STANDUP SLEEPERS



**911**  
FLAT TOP/ C/O CABOVER

## MOUNTING KITS

### AEROLIGHT 700 - PETERBILT

**48700**  
48" HR - HIGH ROOF/  
STANDUP SLEEPER

**63700**  
63" /72" HR - HIGH ROOF/  
STANDUP SLEEPER

**70700**  
70" HR - HIGH ROOF/STANDARD OR  
UNIBILT SLEEPER

### AEROLIGHT 900 - PETERBILT

**63900**  
63" /72" STD FT - STANDARD  
FLATTOP NON-UNIBILT

**50900**  
48" STD FT - STANDARD  
NON-UNIBILT

**36900**  
36" STD FT - STANDARD  
NON-UNIBILT

**63900U**  
63" /72" STD FT - STANDARD  
FLATTOP UNIBILT

**90900**  
90" C/O CAB OVER



**VU190021**  
TURBOWING BRACKET  
STAND-UP SLEEPERS (PB, KW, FL)

## HOOD WINGS

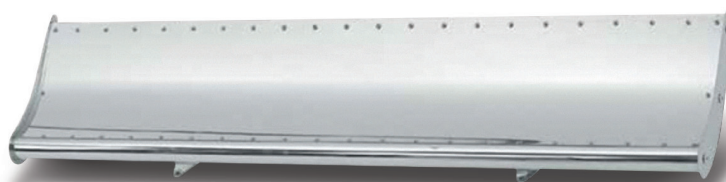

**11131**  
HOOD WINGS - POWER STYLE -  
UNIVERSAL (EXCEPT KW) 42" X 9" X 6"

# WINGMASTER ACCESSORIES

## TURBOWING

### KENWORTH WINGS



**711**  
ALL HIGH ROOF SLEEPERS



**911**  
AEROCAB INTEGRAL/ STANDARD  
FLATTOP/ CAB OVERS

## MOUNTING KITS

### AEROLIGHT 700 - KENWORTH

**KW700**

ALL HR - HIGH ROOF SLEEPERS  
60", 62", 72", 74", & 86" AERODYNE I, II, STUDIO SLEEPERS & STAND UP AEROCAB

### AEROLIGHT 900 - KENWORTH

**62900**  
62" ING - AEROCAB  
INTEGRAL FLATTOP

**60900**  
60" STD FT -  
STANDARD FLATTOP

**42900**  
42" STD FT -  
STANDARD FLATTOP

**72900**  
72" ING - AEROCAB  
INTEGRAL FLATTOP

**49900**  
50" STD FT -  
STANDARD FLATTOP

**37900**  
36" STD FT -  
STANDARD FLATTOP



**VU190021**  
TURBOWING BRACKET  
STAND-UP SLEEPERS (PB, KW, FL)

## HOOD WINGS

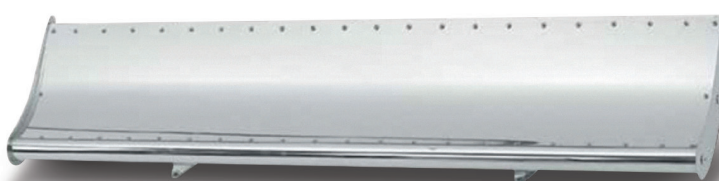

**11151**  
HOOD WINGS POWER STYLE  
42" X 9" X 3"

# WINGMASTER ACCESSORIES

## TURBOWING

### FREIGHTLINER WINGS



**711**

HI-STYLE/STANDARD RAISED ROOF/  
MID ROOF INTEGRAL



**911**

STANDARD INTEGRAL/STANDARD  
FLATTOP/CAB OVER

## MOUNTING KITS

### AEROLIGHT 700 - FREIGHTLINER

**FX711**

BUSINESS CLASS FL50, FL60, FL70, FL80, FL106, FL112, M2(72") WING & BRKTS SOLD TOGETHER

**56700**

58" MR ING - MID ROOF INTEGRAL

**69700**

70" MR ING - MID ROOF INTEGRAL

### TURBOWING 900 - FREIGHTLINER

**70900**

70" ING - STANDARD INTEGRAL  
SLEEPER CAB

**47900**

48" ING - STANDARD INTEGRAL  
SLEEPER CAB

**49900**

50" STD FT - STANDARD FLATTOP  
SLEEPER BOX

**57900**

58" ING - STANDARD INTEGRAL  
SLEEPER CAB

**58900**

60" STD FT - STANDARD FLATTOP  
SLEEPER BOX

**39900**

40" STD FT - STANDARD FLATTOP  
SLEEPER BOX

**86900**

86" C/O - CAB OVER



**VU190021**

TURBOWING BRACKET  
STAND-UP SLEEPERS (PB, KW, FL)

## HOOD WINGS



**11131**

HOOD WINGS - POWER STYLE -  
UNIVERSAL (EXCEPT KW) 42" X 9" X 6"

# WINGMASTER ACCESSORIES

## TURBOWING

### INTERNATIONAL WINGS



**711**  
HIGH ROOF/STANDUP SLEEPERS



**911**  
FLAT TOP/ C/O CABOVER

## MOUNTING KITS

**51700**  
51" H/R - HI-RISE INTEGRAL  
PRO SLEEPER

**72700**  
72" H/R - HI-RISE INTEGRAL  
PRO SLEEPER

## TURBOWING 900 - INTERNATIONAL

**73900**  
72" ING - LO-ROOF INTEGRAL  
PRO SLEEPER

**59900**  
60" STD FT -  
STANDARD FLATTOP

**41900**  
42" STD FT -  
STANDARD FLATTOP

**51900**  
51" ING - LO-ROOF  
INTEGRAL PRO SLEEPER

**48900**  
48" STD FT -  
STANDARD FLATTOP

**86900**  
86" C/O - CAB OVER

**10900**  
110" C/O - CAB OVER

## HOOD WINGS

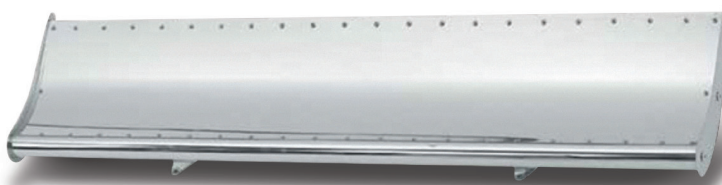

**11131**  
HOOD WINGS - POWER STYLE - UNIVER-  
SAL (EXCEPT KW) 42" X 9" X 6"

# WINGMASTER ACCESSORIES

---

## TURBOWING

### WESTERN STAR WINGS



### AEROLIGHT 700 - WESTERN STAR

WESTERN STAR WINGS HAVE DIFFERENT C-C DIM. 60" SOLID WING & MOUNTING

WC711

70" CONST - CONSTELLATION SERIES



VU190021

TURBOWING BRACKET  
STAND-UP SLEEPERS (PB, KW, FL)

## HOOD WINGS

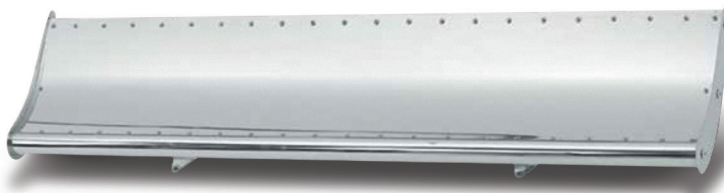

11131

HOOD WINGS - POWER STYLE -  
UNIVERSAL (EXCEPT KW) 42" X 9" X 6"



---

QUALITY TRUCK PARTS



# WINGMASTER ACCESSORIES

## TURBOWING

### PRO TAIL WINGS



**VU194000**

PRO TAIL 72" X 18" HIGH ROOF FLAT  
TOPS ONLY



**VU194001**

PRO TAIL 70" X 11" HIGH ROOF FLAT  
TOPS ONLY



**VU194002**

PRO TAIL 70" X 19" - WING VERSION  
FLAT TOPS ONLY





# WARRANTY & RETURNS

---

Thank you for choosing Valley Chrome bumpers and Wingmaster, a division of Valley Chrome Plating, Inc., as your source for chrome and stainless steel custom truck accessories. Our family of products is fully guaranteed for fit, appearance and quality. Our mission is to provide you with the finest products at a fair price. Our reputation has been built in the trucking industry on our commitment to you, the trucking industry professional.

## LIMITED WARRANTY

Wingmaster extends a warranty against defects in material and workmanship for a period of one year. LED light assemblies come with a three year limited warranty. This warranty is void by damage or defects in appearance due to accident, abuse, alterations to the product, improper installation, corrosive environments or any other abnormal conditions. This warranty applies only to the original purchaser of the product and covers only the defective part, whether it is a single item or component part of a purchased group. The warranty year begins upon purchase of the product by the end user. All requests for warranty must include the original invoice. Serial numbers must be provided for bumpers, wings and any other serialized parts. There is no warranty for setback axle bumpers ("break-backs") 20" and wider. Flat bumpers 20" and wider may require additional brackets and bracing (not included) to avoid cracking, and may not be warranted if our company determines the bracing is insufficient.

## RETURN POLICY

Products must be returned to our Clovis, Ca. facility with a Returned Goods Authorization number, freight prepaid. Items sent without an R.G.A. number or freight collect will be refused. Wingmaster reserves the right to repair or replace the item at our discretion. Warranted items will be returned freight prepaid upon acceptance of our responsibility of the defect. Please contact our customer service staff for the R.G.A. number. Items may not be returnable due to age or stored condition, which is at our company's discretion.

## FREIGHT POLICY

All freight is F.O.B. from our Clovis, Ca. facility unless prepaid conditions are met.

Dealers/Distributors: see your published price list for the freight policy that applies to you. Bumpers, Turbowings, battery boxes and tool boxes can be combined to achieve prepaid status.

Accessories may be combined with bumper and/or wing orders at our discretion.

## IMAGES IN THIS CATALOG

The images shown in this catalog are best representations of our products, however, they are representative only and may sometimes not match actual product. Add-on items shown in images, such as external tow apparatus, fog lamps and other non-Valley Chrome/Wingmaster items attached to bumpers and accessories are not included in the product offered.

## UPDATED INFORMATION

Information in this catalog, when printed by our company, is made as accurate as possible at the time of printing. For the most current information, including error corrections, see the most current catalog posted on our website. Because of the truck and automotive industry's aftermarket publishing inconsistencies, some model years and vehicle models indicated in this publication may vary slightly from the actual model. Obtain product drawings and photos from our customer service staff to verify product fit prior to ordering.



**Valley  
Chrome  
Plating**

---

**QUALITY TRUCK PARTS**

Call for a Dealer Near You **1.800.354.0976**

[www.valleychrome.com](http://www.valleychrome.com) • 1028 HOBLITT AVE. • CLOVIS, CA 93612 • USA

*Bumpers & Wingmaster  
Stainless Accessories are...*

FOLLOW US

